

Typical unit

**FEATURES**

- Settable output voltage from 0.7 to 1.8Vdc
- Up to 16A of output current
- Quick response to load change
- Ultra small surface mount package 10.5 x 9.0 x 5.0mm
- High efficiency of 94.0% max.
- Outstanding thermal derating performance
- Over current protection
- On/Off control (Positive logic)
- Power Good signal
- High Reliability / Heat Shock Testing 700cycle (-40 to +125degC)
- PMBus™ interface available
- PMBus™ 1.3 ready
- Minimum Vout setting resolution 2mV/bit

**PRODUCT OVERVIEW**

The **MYMGM1R816ELA5RA** is miniature MonoBK™ called “Mono Block”, non-isolated Point-of-Load (PoL) DC-DC power converters for embedded applications. The small form factor measures only 10.5 x 9.0 x 5.0 mm. Applications include powering FPGA/CPU's, datacom/telecom systems, Distributed Bus Architectures (DBA), programmable logic and mixed voltage systems.

The converter has input voltage ranges of 7.5 to 15Vdc and a maximum output current of 16A. Based on a fixed frequency synchronous buck converter switching topology, this high power conversion efficient PoL module features programmable output voltage 0.7 to 1.8Vdc, On/Off control, Power Good signal output and PMBus™ ALERT output.

These converters also include under voltage lock out (UVLO), output short circuit protection and over-current protection. Moreover this converter has PMBus™ interface so various parameters can be handled and monitored by digital signals.

**SIMPLIFIED APPLICATION**

MYMGM1R824ELA5RA

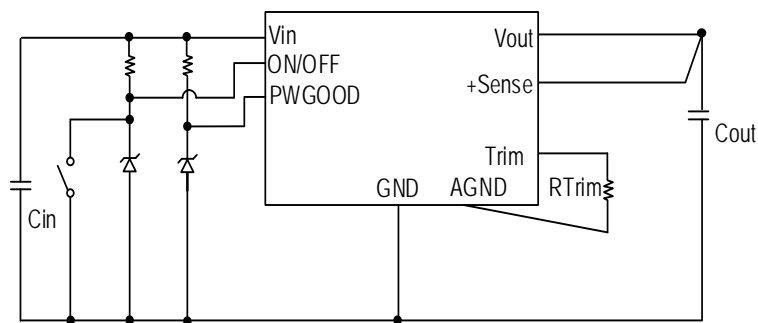

MYMGM1R816ELA5RA  
Cin : 22uF/25V x 2pcs  
Co : 220uF/4V x 3pcs

(Typical topology is shown. Murata recommends an external input fuse.)

**PERFORMANCE SPECIFICATIONS SUMMARY AND ORDERING GUIDE (Including series products)**

PART NUMBER	OUTPUT					INPUT				Efficiency (%)	ON/OFF	PACKAGE (mm)	
	Vout (V)	Iout (A,max.)	Power (W)	R/N typ. (% of Vout)	Regulation(max.)		Vin typ. (V)	Range (Vdc)	Iin no load (mA)				Iin full load (A)
					Line(%)	Load(%)							
MYMGM1R816ELA5RA	0.7-1.8	16	28.8	1.0	±0.5	±0.5	12	7.5-15.0	80	4.3	91.8	Yes (Positive)	10.5 x 9.0 x 5.0
MYMGM1R816ELA5RAD	0.7-1.8	16	28.8	1.0	±0.5	±0.5	12	7.5-15.0	80	4.3	91.8	Yes (Positive)	10.5 x 9.0 x 5.0

1.All specifications are at typical line voltage, Vout = 1.8V and full load, +25degC unless otherwise noted. Output capacitors are 220uF x 3 ceramic. Input capacitors is 22uF x 2 ceramic or 47uF x 2 ceramic and plenty electrolytic capacitors. See detailed specifications. Input and Output capacitors are necessary for our test equipment.  
2.Use adequate ground plane and copper thickness adjacent to the converter.

**PART NUMBER STRUCTURE**

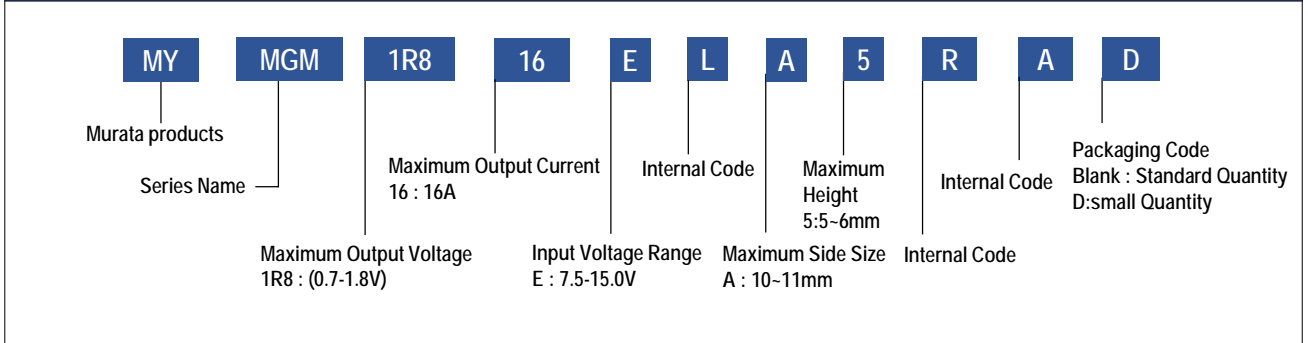

**Product Marking**

Because of the small size of these products, the product marking contains a character-reduced code to indicate the model number and manufacturing date code. Not all items on the marking are always used. Please note that the marking differs from the product photograph. Here is the layout of the Marking.

Part Number	Product Code
MYMGM1R816ELA5RA	M1R816ELA5RA
MYMGM1R816ELA5RAD	M1R816ELA5RA

Layout (reference)

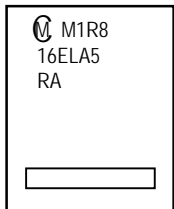

Codes(reference)

- Ⓜ 1Pin Marking  
M1R816ELA5RA Product code  
(Please see product code table beside)
- Internal Manufacturing code

## FUNCTIONAL SPECIFICATIONS OF MYMGM1R816ELA5RA (Note 1)

ABSOLUTE MAXIMUM RATINGS		Conditions	Minimum	Typical	Maximum	Units
Input Voltage			-0.3		16	Vdc
ON/OFF,PWGOOD,SCL,SDA,ADDR,ALT Pins		Power on, referred to -Vin	-0.3		3.9	Vdc
Trim Pin		Power on, referred to -Vin			3.9	Vdc
Vout			0.7		2.0	Vdc
Output Current		Current-limited, no damage, short-circuit protected	0		16	A
Storage Temperature Range		Vin = Zero (no power)	-40		125	degC
Absolute maximums are stress ratings. Exposure of devices to greater than any of these conditions may adversely affect long-term reliability. Proper operation under conditions other than those listed in the Performance/Functional Specifications Table is not implied or recommended.						
INPUT		Conditions	Minimum	Typical	Maximum	Units
Operating Voltage Range			7.5	12	15	Vdc
Start-up Threshold		Rising input voltage		7.25		Vdc
Under Voltage Shutdown		Note 12		6.75		Vdc
Internal Filter Type				Capacitive		
Input Current						
Ful Load Conditions		Vin = 12.0V, Vout = 1.8V, Iout = 16A		2.7		A
Low Line		Vin = 8.0V, Vout = 1.8V, Iout = 16A		4.3		A
No Load Current		Iout=0A, unit = ON		100		mA
Shut-Down Mode Input Current				1		mA
GENERAL and SAFETY		Conditions	Minimum	Typical	Maximum	Units
Efficiency		Vin = 12.0V, Vout = 1.8V, Iout = 16A		91.8		%
		Vin = 12.0V, Vout = 1.0V, Iout = 16A		87.0		
Calculated MTBF (Note 3)		+40degC, Vin = 12.0V, Vout = 1.8V, Iout = 50%		8.45x10 <sup>6</sup>		hours
DYNAMIC CHARACTERISTICS		Conditions	Minimum	Typical	Maximum	Units
Fixed Switching Frequency				400		kHz
Startup Time (Vin ON)		Vout = 1.8V (Vout = 5% to 90% of Vout)		2		ms
Startup Time (Remote ON)		Vout = 1.8V (Vout = 5% to 90% of Vout)		2		ms
Dynamic Load Peak Deviation		Vin = 12V, Vout = 1.0V, Iout = 50-100% ,Note16		±3.0%		Voset
FUNCTIONS		Conditions	Minimum	Typical	Maximum	Units
Remote On/Off Control (Note 4)						
Logic						
ON State Range			2.15		3.6	V
OFF Stage Range			-0.3		1.2	V
Control Current		Open collector/drain			-	mA
Power-Good Output (Pulled up to 5.0Vreg(typ.) internally)						
PGood TRUE (HI)			(Voset x 90%) < Vout < (Voset x 115%)			
PGood FALSE (LO)			Out of above range			
OUTPUT		Conditions	Minimum	Typical	Maximum	Units
Total Output Power		See Derating	0		28.8	W
Voltage						
Output Voltage Range		Note 10	0.7		1.8	Vdc
Minimum Loading				Note		
Accuracy (50% load, untrimmed)		Vin = 12V, Vout = 1.8V, Cout = 660uF, Ta = 25degC		±1		% of Vout
Over Voltage Protection		Note 13		>120%		Vout
Under Voltage Protection				<70%		Vout
Current						
Output Current Range		Note 2	0		16	A
Current Limit Inception		After warmup		24		A
Short Circuit						
Short Circuit Duration (remove short for recovery)		Output shorted to ground, no damage		Continuous		
Short Circuit Protection Method		Note 5		Hiccup		
Pre-bias Start-up		Converter will start up if the external output voltage is less than set Vout.				
Regulation (Note 8)						
Line Regulation (Note 17)		Vin = min. to max. Ta = min. to max.			±1.0	% of Vout
Temperature variation				±1.5		% of Vout
Total output voltage variation (Note 17)		Iout = min. to max.			±3	%
Ripple and Noise (20MHz bandwidth)		Note 6			30	mV pk-pk
External Output Capacitance Range (Note 11)			660		5000	uF

## COMMON SPECIFICATION

MECHANICAL(Common)	Conditions	Minimum	Typical	Maximum	Units
Mechanical Dimension	L x W x H	10.5(typ.) x 9.0(typ.) x 5.0(max.)			mm
Weight			1.5		grams
ENVIRONMENTAL(Common)	Conditions	Minimum	Typical	Maximum	Units
Operating Ambient Temperature Range	With Derating (Note 2, 7)	-40		105	degC
Storage Temperature Range	Vin = Zero (no power)	-40		125	degC
Thermal Resistance(Reference data) $\Psi_{jt}$	Vin=12V, Vout=1.8V, Iout=16A (Note 15)		1.7		degC/W
	Vin=12V, Vout=1.8V, Iout=8A (Note 15)		2.2		degC/W
Maximum Junction Temperature				125	degC
Thermal Protection/Shutdown	Measured in module (Note 9,14)		155		degC
Thermal Protection/Shutdown (Recovery)	Measured in module (Note 9,14)		135		degC
Moisture Sensitivity Level			3		

## Specification Notes

(1) Specifications are typical at +25degC, Vin=typical +12.0V. (MYMGM1R816ELA5RA), Vout=typical (+1.8V), full load, external caps and natural convection unless otherwise indicated. All models are tested and specified with external 220uF x 3 ceramic output capacitors, 22uF x 2 (for MYMGM1R816ELA5RA) ceramic and plenty electrolytic external input capacitors. All capacitors are low ESR types. These capacitors are necessary to accommodate our test equipment and may not be required to achieve specified performance in your applications. However, Murata recommends installation of these capacitors.

Several parameters can be changed by PMBus. (See PMBus interface later)

(2) Note that Maximum Power Derating curves indicate an average current at typical input voltage. At higher temperatures and/or no airflow, the converter will tolerate brief full current outputs if the total RMS current over time does not exceed the Derating curve.

(3) Mean Time Between Failure is calculated using the Telcordia SR-332 method, +40degC, half output load, natural air convection.

(4) The On/Off Control Input should use either a switch or an open collector/open drain transistor referenced to GND. A logic gate may also be used by applying appropriate external voltages which do not exceed +Vin

(5) "Hiccup" overcurrent operation repeatedly attempts to restart the converter with a brief, full-current output. If the overcurrent condition still exists, the restart current will be removed and then tried again. This short current pulse prevents overheating and damaging the converter. Once the fault is removed, the converter immediately recovers normal operation.

(6) Output noise may be further reduced by adding an external filter. At zero output current, the output may contain low frequency components which exceed the ripple specification. The output may be operated indefinitely with no load.

(7) All models are fully operational and meet published specifications, including "cold start" at -40degC.

(8) Regulation specifications describe the deviation as the line input voltage or output load current is varied from a midpoint value to either extreme.

(9) Thermal Protection/Shutdown temperature is measured with the sensor in the converter.

(10) Do not exceed maximum power specifications when adjusting the output trim.

(11) The maximum output capacitive loads depend on the Equivalent Series Resistance (ESR) of the external output capacitor and, to a lesser extent, the distance and series impedance to the load. Larger caps will reduce output noise but may change the transient response. Newer ceramic caps with very low ESR may require lower capacitor values to avoid instability. Thoroughly test your capacitors in the application.

(12) Do not allow the input voltage to degrade lower than the input under voltage shutdown voltage at all times. Otherwise, you risk having the converter turn off. The under voltage shutdown is not latching and will attempt to recover when the input is brought back into normal operating range.

(13) The outputs are intended to sink appreciable reverse current.

(14) When the temperature decreases below the turn-in threshold, the converter will automatically restart.

(15) The thermal resistances are only reference data, and they are measured with our evaluation board as below.

50.8mm x 60.0mm x 1.6mm (8 Layer, 2oz copper each)FR-4.

(16) About di/dt condition, please refer to the table described later.

(17) Ensured by design. Not production tested.

Internal Circuit Diagrams

ON/OFF internal circuit diagram and using guide

This product needs pulling up this terminal.

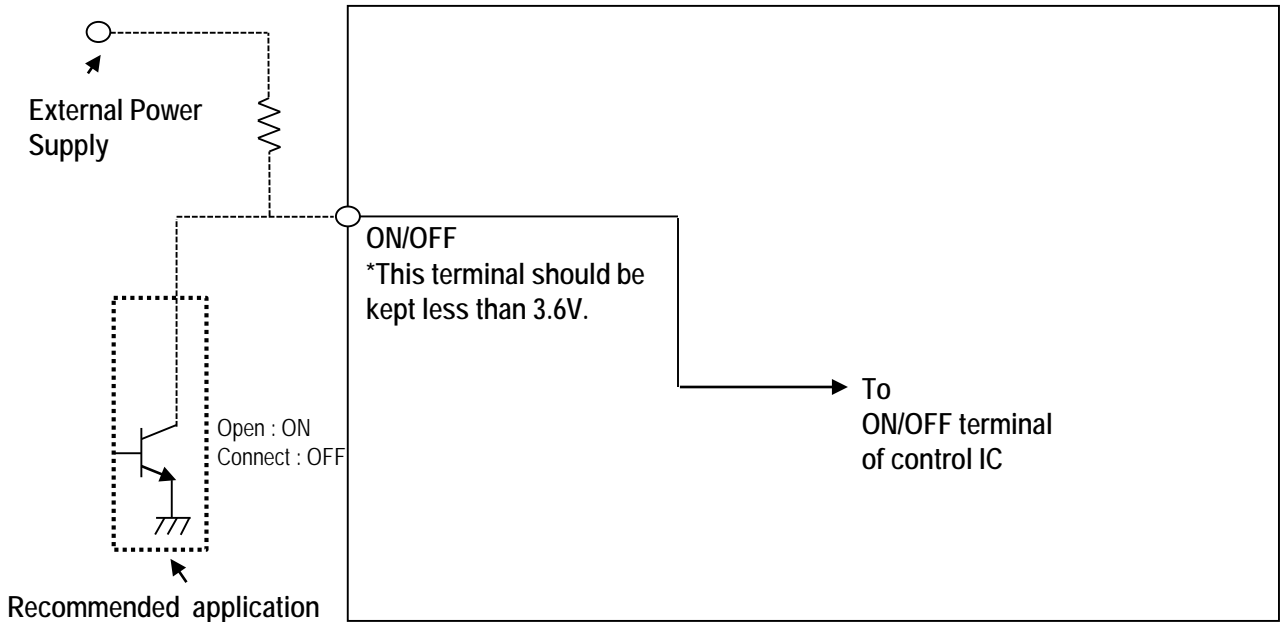

Power Good(P.G) internal circuit diagram and using guide

This product needs pulling up this terminal.

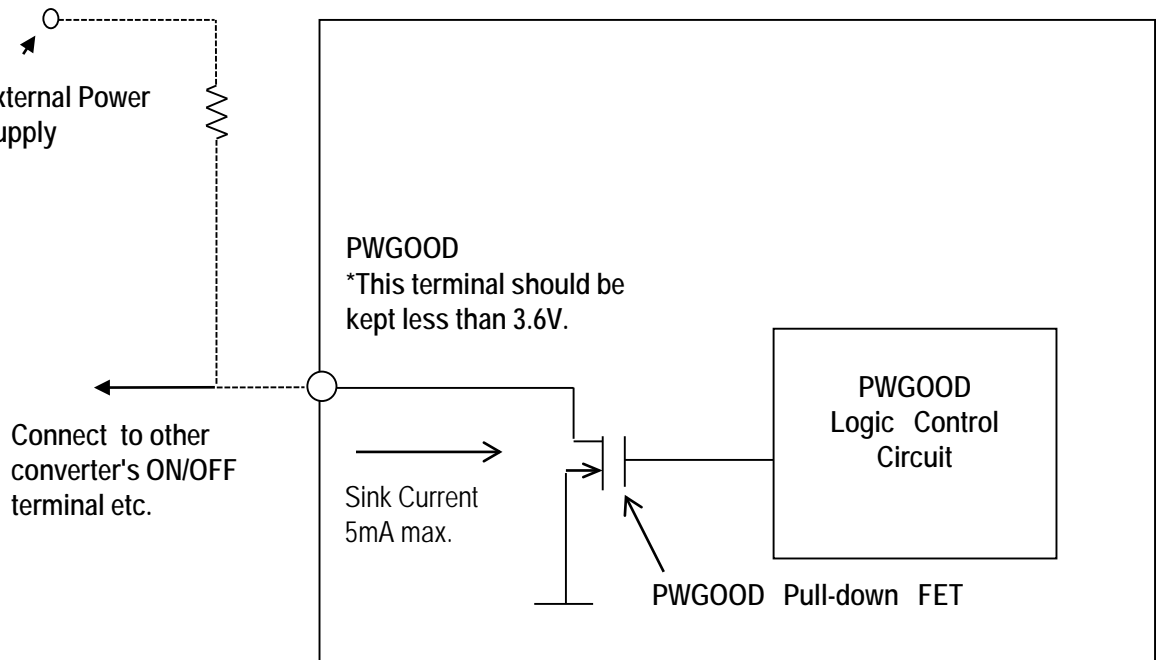

**PERFORMANCE DATA AND OSCILLOGRAMS OF MYMGM1R816ELA5RA**

Efficiency vs. Line Voltage and Load Current @ +25degC. (Vout = 0.7V)

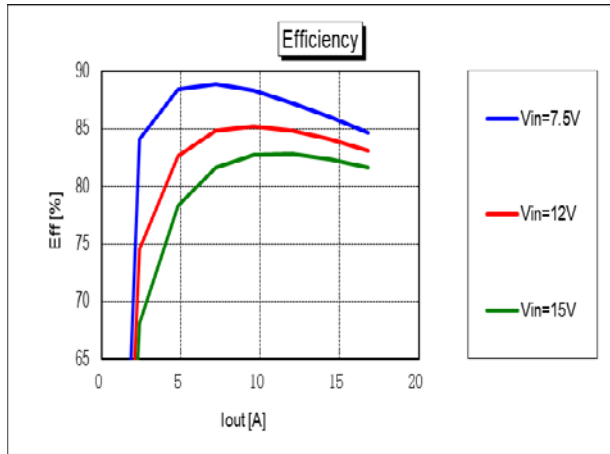

Vout vs. Line Voltage and Load Current @ +25degC. (Vout = 0.7V)

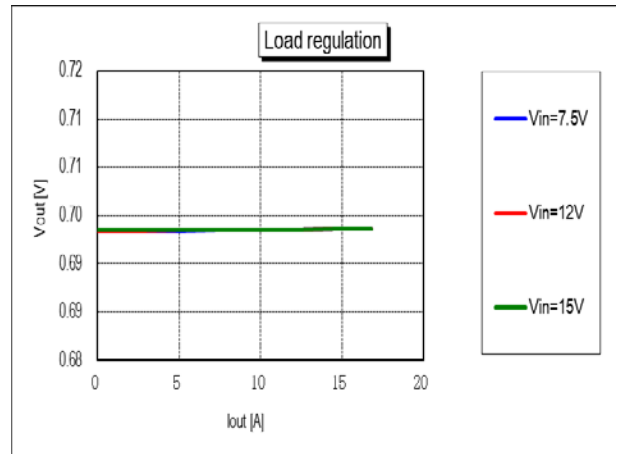

On/Off Enable Delay (Vin=12V, Vout=0.7V, Iout=16A, Load=660uF)

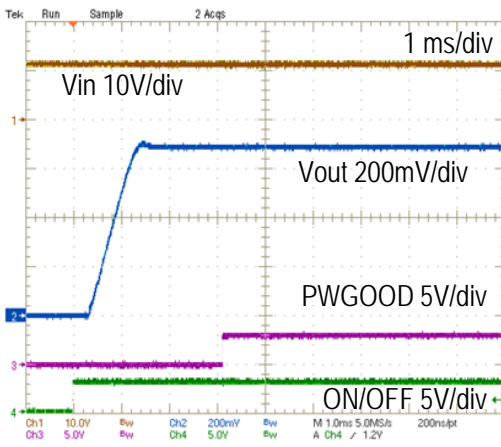

Output Ripple and Noise (Vin=12V, Vout=0.7V, Iout=16A, Load=660uF, Scope BW=20MHz)

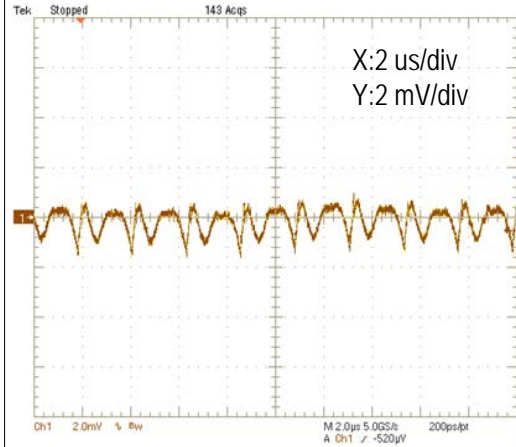

Step Load Transient Response (Vin=12V, Vout=0.7V, Load=660uF, Iout=8A to 16A 2.4A/us)

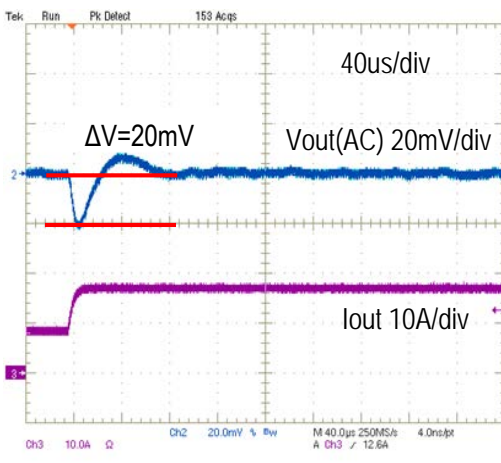

Step Load Transient Response (Vin=12V, Vout=0.7V, Load=660uF, Iout=16 to 8A 2.4A/us)

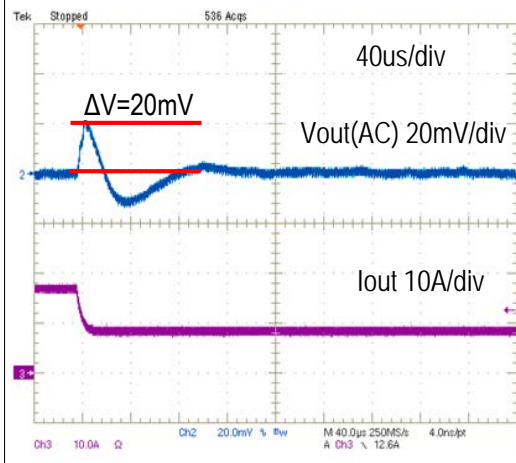

**PERFORMANCE DATA AND OSCILLOGRAMS OF MYMGM1R816ELA5RA**

Efficiency vs. Line Voltage and Load Current @ +25degC. (Vout = 1.0V)

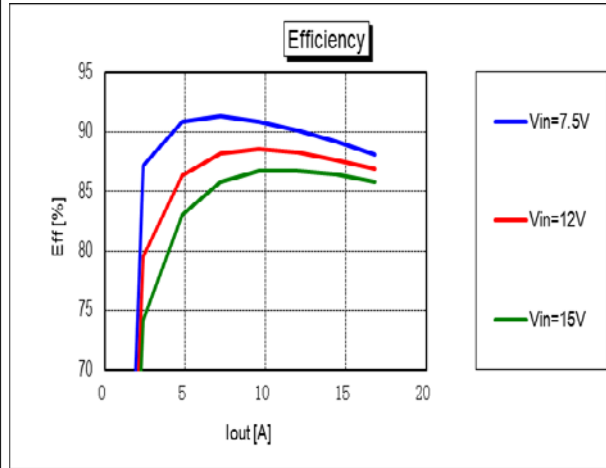

Vout vs. Line Voltage and Load Current @ +25degC. (Vout = 1.0V)

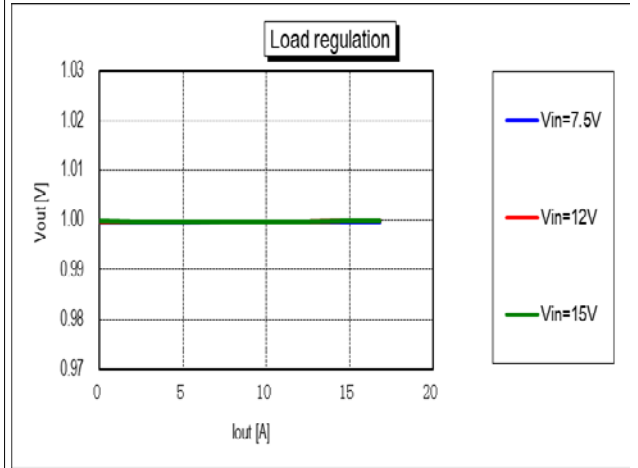

On/Off Enable Delay (Vin=12V, Vout=1.0V, Iout=16A, Cload=660uF)

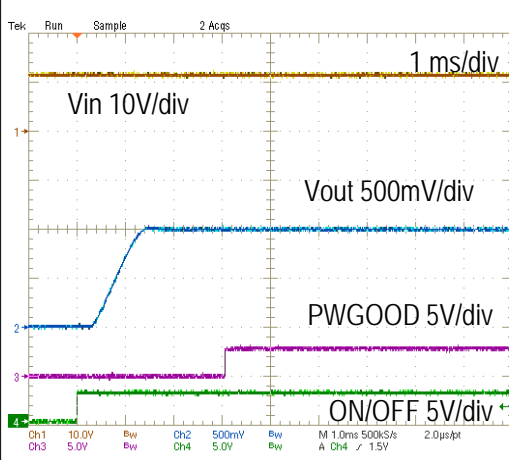

Output Ripple and Noise (Vin=12V, Vout=1.0V, Iout=16A, Cload=660uF, Scope BW=20MHz)

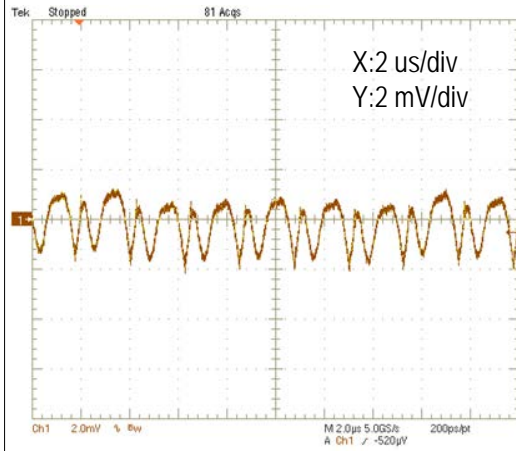

Step Load Transient Response (Vin=12V, Vout=1.0V, Cload=660uF, Iout=8A to 16A 2.4A/us)

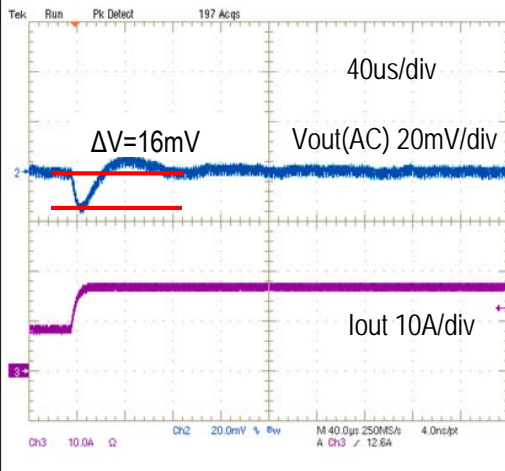

Step Load Transient Response (Vin=12V, Vout=1.0V, Cload=660uF, Iout=16 to 8A 2.4A/us)

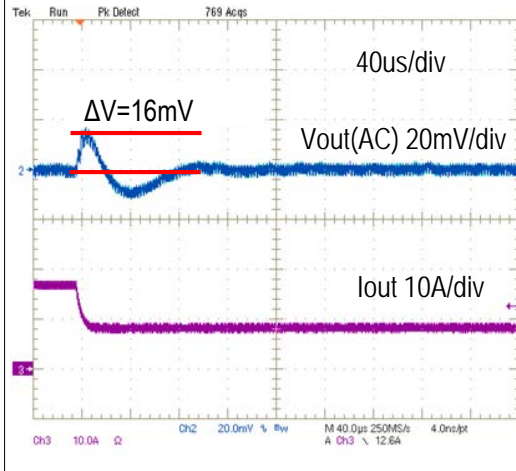



**PERFORMANCE DATA AND OSCILLOGRAMS OF MYMGM1R816ELA5RA**

Efficiency vs. Line Voltage and Load Current @ +25degC. (Vout = 1.8V)

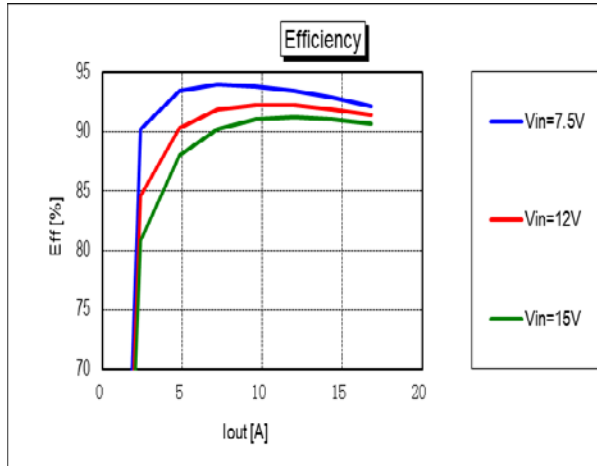

Vout vs. Line Voltage and Load Current @ +25degC. (Vout = 1.8V)

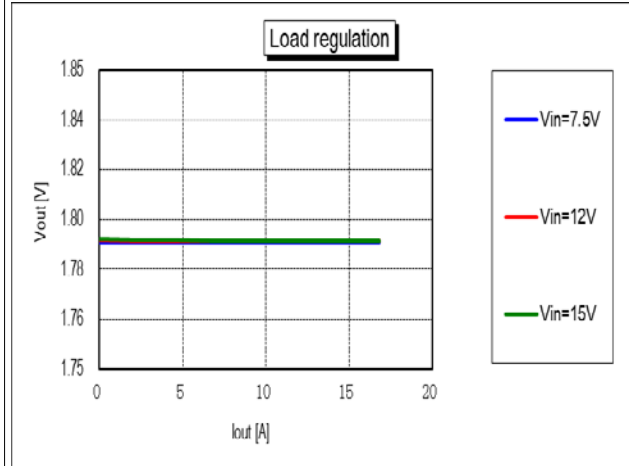

On/Off Enable Delay (Vin=12V, Vout=1.8V, Iout=16A, Cload=660uF)

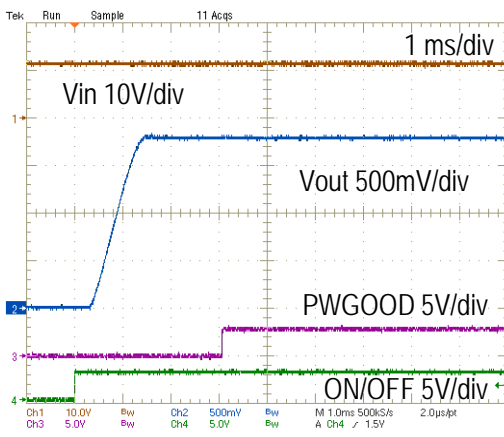

Output Ripple and Noise (Vin=12V, Vout=1.8V, Iout=16A, Cload=660uF, Scope BW=20MHz)

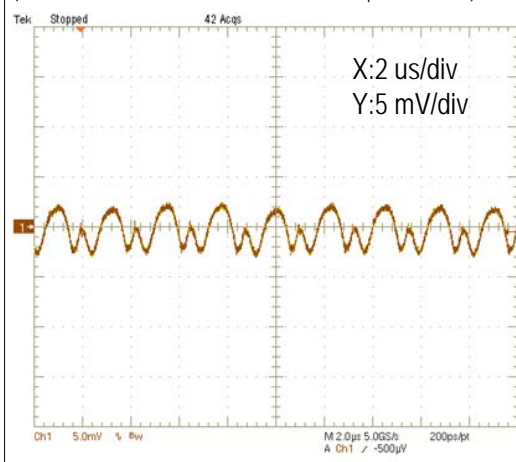

Step Load Transient Response (Vin=12V, Vout=1.8V, Cload=660uF, Iout=8A to 16A 2.4A/us)

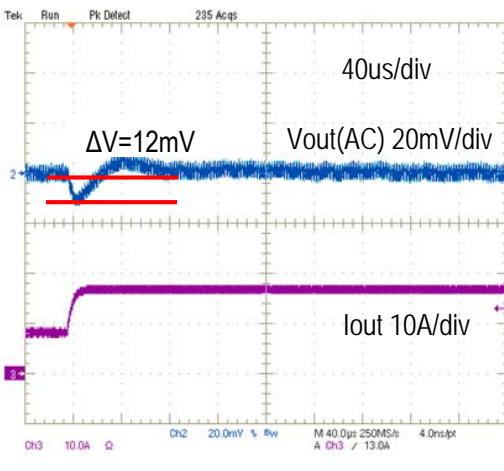

Step Load Transient Response (Vin=12V, Vout=1.8V, Cload=660uF, Iout=16 to 8A 2.4A/us)

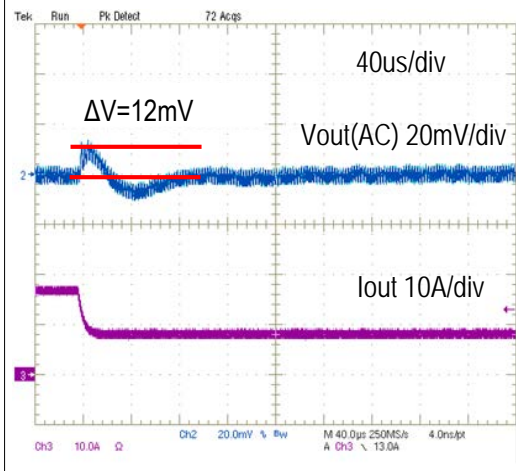



**THERMAL DERATINGS OF MYMGM1R816ELA5RA**

**MYMGM1R816ELA5RA**

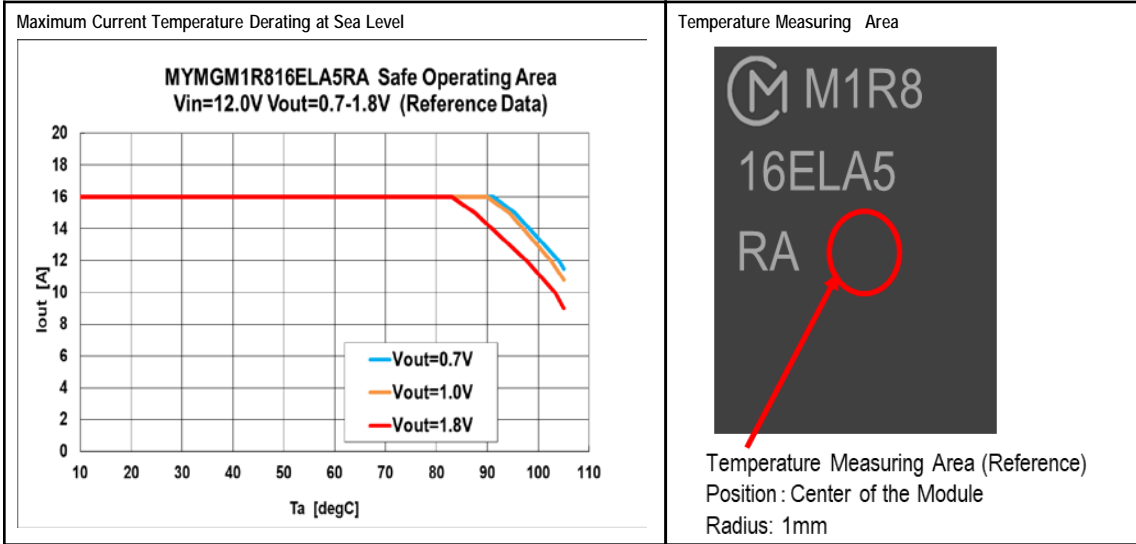

Thermal deratings are evaluated in following condition.

- The product is mounted on 50.8mm x 60.0mm x 1.6mm (8 Layer, 2oz copper each) FR-4 board respectively.
  - No forced air flow.
- Surface(Top of the coil) temperature of the product : 110degC max

**TRANSIENT RESPONSE DATAS OF MYMGM1R816ELA5RA**

Transient response data at various conditions are showed in following table.

Minimum output capacitance can serve less than 3% x Vout of deviation for 8A load change(2.4A/us).

Vout(V)	Vin(V)	Cout(uF)	Voltage Deviation(mV)
			8-16A Load Step (2.4A/us)
0.7	12	660	21
1			16
1.2			15
1.8			12

**MECHANICAL SPECIFICATIONS**

**Dimension and Pin Assignment**

< Top View >

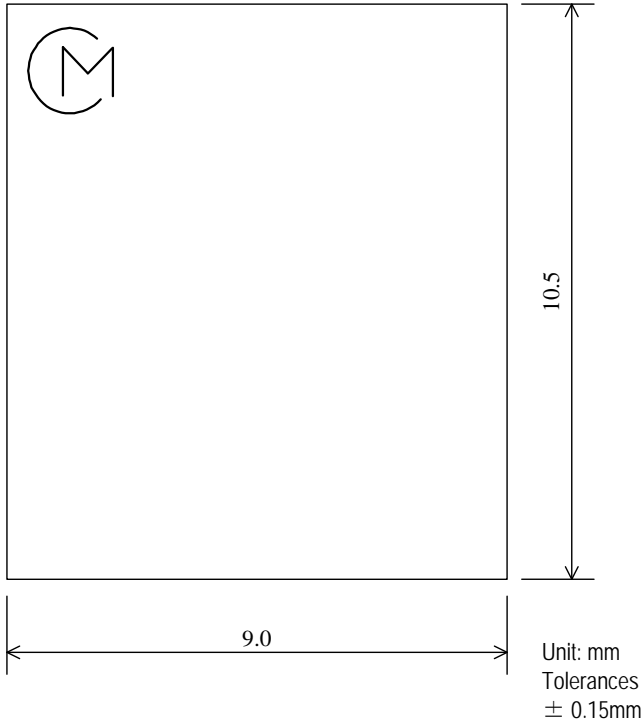

< Bottom View >

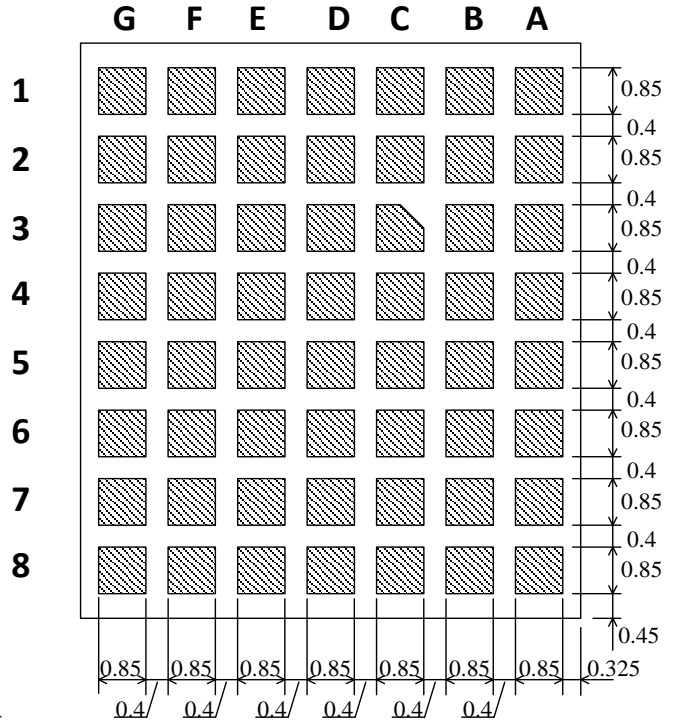

< Side View >



INPUT/OUTPUT CONNECTIONS			
Pin	Function	Pin	Function
A1	PMBus™ CLK(SCL)	D7,D8	Output Voltage
A2	PMBus™ DATA(SDA)	E1,E2	Input Voltage
A3	PMBus™ ALERT(ALT#)	E3-E8	GND
A4	Remote ON/OFF	F1,F2	Input Voltage
A5	Power Good	F3-F8	GND
A6,A7	No Connection	G1	No Connection
A8	Output Voltage	G2	Analog GND
B1-B6	GND	G3	Vout Trimming
B7,B8	Output Voltage	G4	Vout +Sense
C1-C6	GND	G5	No Connection
C7,C8	Output Voltage	G6	PMBus™ Address
D1,D2	Input Voltage	G7,G8	No Connection
D3-D6	GND		

Recommended Board Land Pattern (Top View)

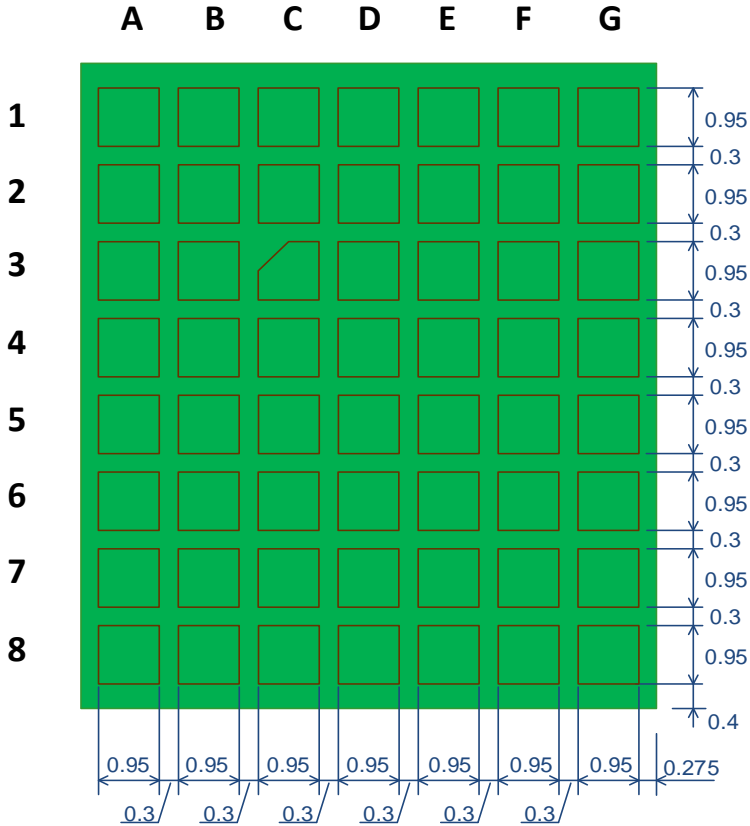

Unit: mm

Example of Pattern Layout (Top View)

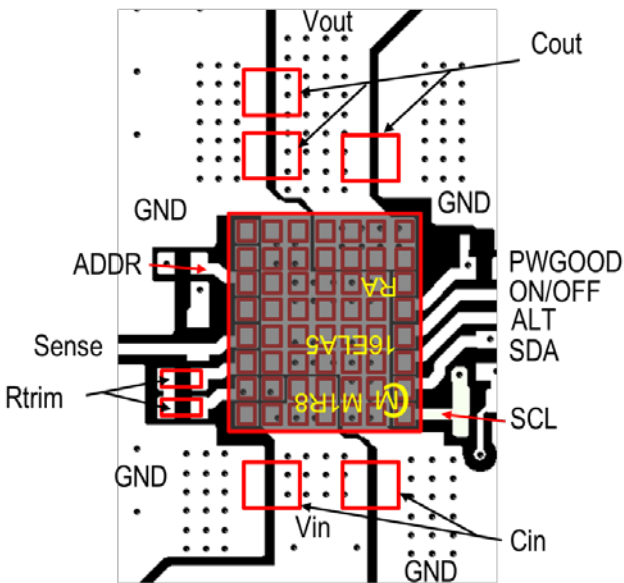

Picture

TOP VIEW



21.3x11.0(mm)

BOTTOM VIEW

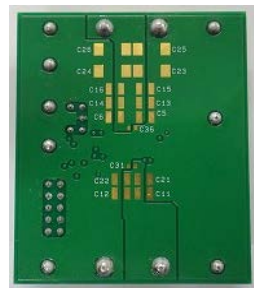

TAPE AND REEL INFORMATION

Tape Dimension

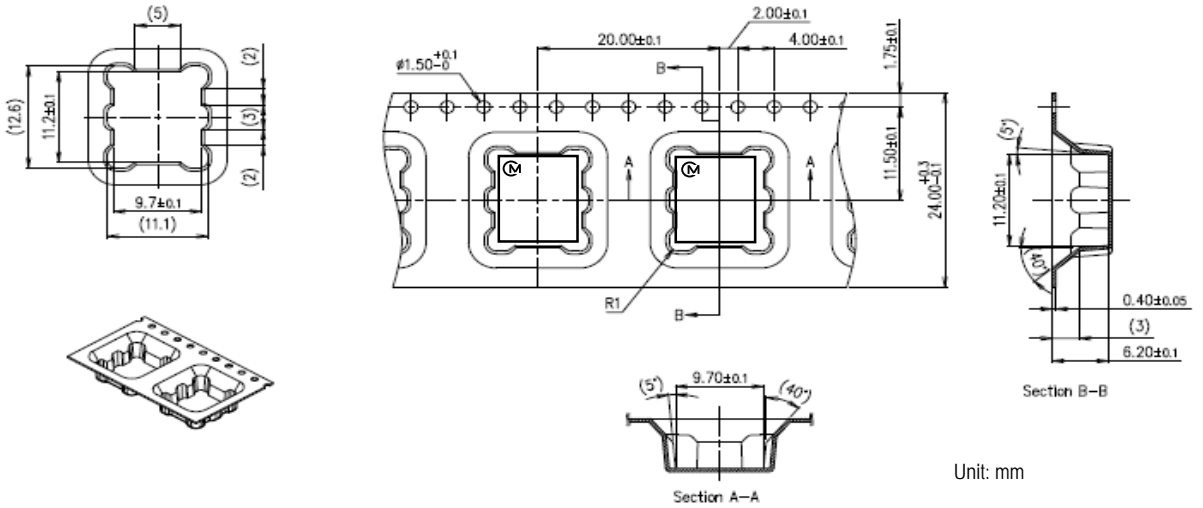

Reel Dimension

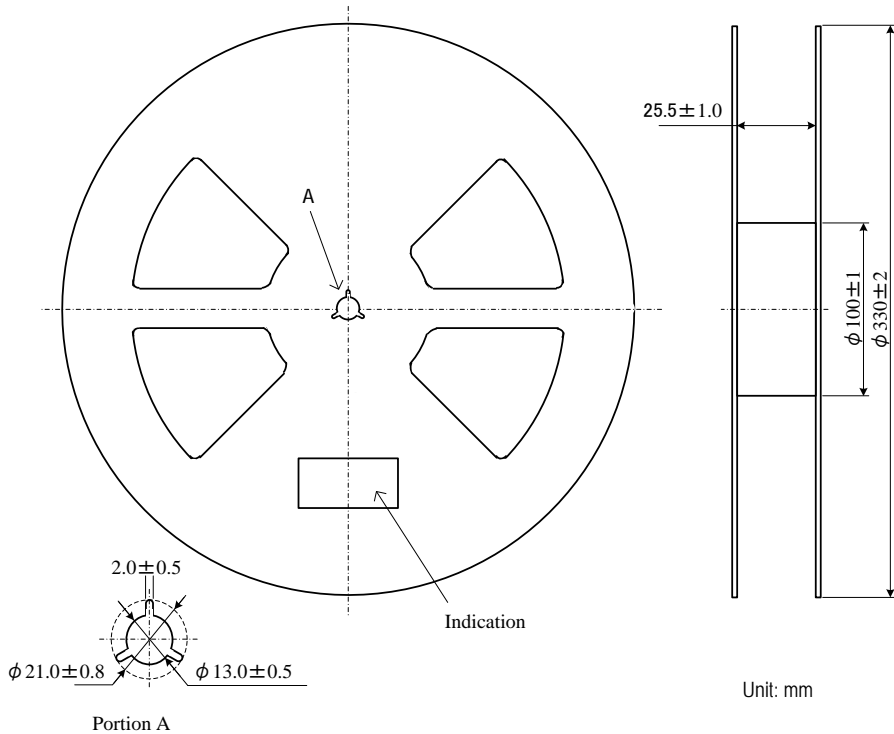

**TAPE SPECIFICATIONS**

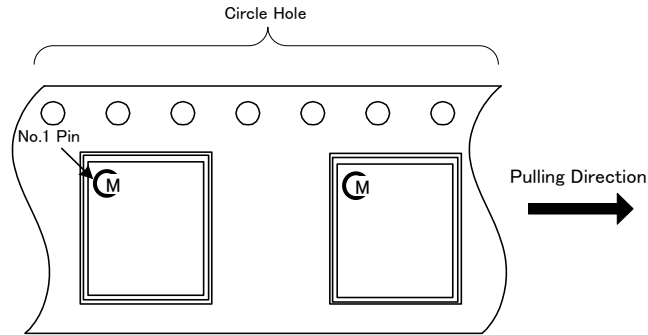
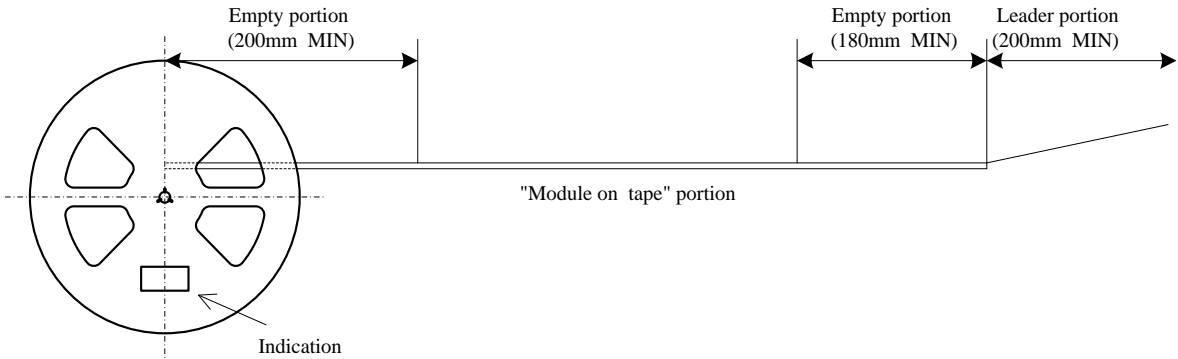

**Note**

1. The adhesive strength of the protective tape must be within 0.1-1.3N.
2. Each reel contains the quantities such as the table below.
3. Each reel set in moisture-proof packaging because of MSL 3.
4. No vacant pocket in "Module on tape" section.
5. The reel is labeled with Murata part number and quantity.
6. The color of reel is not specified.

Part Number	Qty(pcs)
MYMGM1R816ELA5RA	400
MYMGM1R816ELA5RAD	100

TECHNICAL NOTES

**Input Fuse**

Certain applications and/or safety agencies may require fuses at the inputs of power conversion components. Fuses should also be used when there is the possibility of sustained input voltage reversal which is not current limited. For greatest safety, we recommend a fast blow fuse installed in the ungrounded input supply line. The installer must observe all relevant safety standards and regulations. For safety agency approvals, install the converter in compliance with the end-user safety standard.

**Input Under-Voltage Shutdown and Start-Up Threshold**

Under normal start-up conditions, converters will not begin to regulate properly until the ramping-up input voltage exceeds and remains at the Start-Up Threshold Voltage (see Specifications). Once operating, converters will not turn off until the input voltage drops below the Under-Voltage Shutdown Limit. Subsequent restart will not occur until the input voltage rises again above the Start-Up Threshold. This built-in hysteresis prevents any unstable on/off operation at a single input voltage.

Users should be aware however of input sources near the Under-Voltage Shutdown whose voltage decays as input current is consumed (such as capacitor inputs), the converter shuts off and then restarts as the external capacitor recharges. Such situations could oscillate. To prevent this, make sure the operating input voltage is well above the UV Shutdown voltage at all times.

**Start-Up Time**

Assuming that the output current is set at the rated maximum, the Vin to Vout Start-Up Time (see Specifications) is the time interval between the point when the ramping input voltage crosses the Start-Up Threshold and the fully loaded regulated output voltage enters and remains within its specified accuracy band. Actual measured times will vary with input source impedance, external input capacitance, input voltage slew rate and final value of the input voltage as it appears at the converter.

This converter includes a soft start circuit to moderate the duty cycle of its PWM controller at power up, thereby limiting the input inrush current. The On/Off Remote Control interval from On command to Vout regulated assumes that the converter already has its input voltage stabilized above the Start-Up Threshold before the On command. The interval is measured from the On command until the output enters and remains within its specified accuracy band. The specification assumes that the output is fully loaded at maximum rated current. Similar conditions apply to the On to Vout regulated specification such as external load capacitance and soft start circuitry.

**Recommended Input Filtering**

The user must assure that the input source has low AC impedance to provide dynamic stability and that the input supply has little or no inductive content, including long distributed wiring to a remote power supply. For best performance, we recommend installing a low-ESR capacitor immediately adjacent to the converter's input terminals.

The capacitor should be a ceramic type such as the Murata GRM32 series and a electrolytic type such as Panasonic OS-CON series. Initial suggested capacitor values are 22uF x 2 ceramic type and 1000uF x 1 electrolytic type, rated at twice the expected maximum input voltage. Make sure that the input terminals do not go below the under voltage shutdown voltage at all times. More input bulk capacitance may be added in parallel (either electrolytic or tantalum) if needed.

**Recommended Output Filtering**

The converter will achieve its rated output ripple and noise with additional external capacitor. The user may install more external output capacitance reduce the ripple even further or for improved dynamic response. Again, use low-ESR ceramic (Murata GRM32 series). Initial values of 220uF x 3 ceramic type may be tried, either single or multiple capacitors in parallel. Mount these close to the converter. Measure the output ripple under your load conditions. Use only as much capacitance as required to achieve your ripple and noise objectives. Excessive capacitance can make step load recovery sluggish or possibly introduce instability. Do not exceed the maximum rated output capacitance listed in the specifications.

**Output Noise**

This converter is tested and specified for output noise using designated external output components, circuits and layout as shown in the figures below. In the figure below, the two copper strips simulate real-world printed circuit impedances between the power supply and its load. In order to minimize circuit errors and standardize tests between units, scope measurements should be made using BNC connectors or the probe ground should not exceed one half inch and soldered directly to the test circuit.

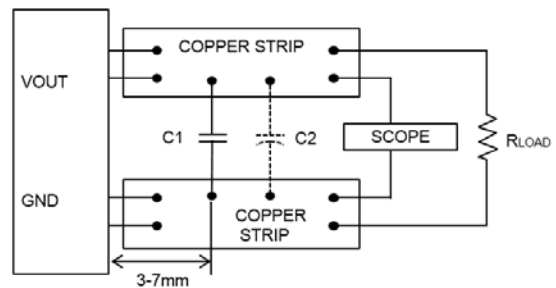

C1=220uF x 3 CERAMIC

C2=OPEN

Figure : Measuring Output Ripple and Noise

**Minimum Output Loading Requirements**

This converter regulates within specification and are stable under no load to full load conditions. Operation under no load might however slightly increase output ripple and noise.

**Thermal Shutdown**

To prevent many over temperature problems and damage, these converters include thermal shutdown circuitry. If environmental conditions cause the temperature of the converter's to rise above the Operating Temperature Range up to the shutdown temperature, an on-board electronic temperature sensor will shut down the unit. When the temperature decreases below the turn-on threshold, the converter will automatically restart.



**CAUTION:** If you operate too close to the thermal limits, the converter may shut down suddenly without warning. Be sure to thoroughly verify your application to avoid unplanned thermal shutdown.

#### Temperature Derating Curves

The graph in this data sheet illustrates typical operation under a variety of conditions. The derating curves show the maximum continuous ambient air temperature. Note that these are AVERAGE measurements.

Note that the temperatures are of the ambient airflow, not the converter itself which is obviously running at higher temperature than the outside air. Also note that very low flow rates (below about 25 LFM) are similar to "natural convection," that is, not using fan-forced airflow. Murata makes Characterization measurements in a closed cycle wind tunnel with calibrated airflow. We use both thermocouples and an infrared camera system to observe thermal performance.

**CAUTION:** This graph is collected at slightly above Sea Level altitude. Be sure to reduce the derating for higher density altitude.

#### Output Current Limiting

Current limiting inception is defined as the point at which full power falls below the rated tolerance. See the Performance/Functional Specifications. Note particularly that the output current may briefly rise above its rated value in normal operation as long as the average output power is not exceeded. This enhances reliability and continued operation of your application. If the output current is too high, the converter will enter the short circuit condition.

#### Output Short Circuit Condition

When a converter is in current-limit mode, the output voltage will drop as the output current demand increases. Following a time-out period, the converter will restart, causing the output voltage to begin ramping up to its appropriate value. If the short-circuit condition persists, another shutdown cycle will initiate. This rapid on/off cycling is called "hiccup mode". The hiccup cycling reduces the average output current, thereby preventing excessive internal temperatures and/or component damage. A short circuit can be tolerated indefinitely.

The "hiccup" system differs from older latching short circuit systems because you do not have to power down the converter to make it restart. The system will automatically restore operation as soon as the short circuit condition is removed.

#### Power Good (PWGOOD)

Please refer to the Connection Diagram on page 1 for PWGOOD connection.

The Product has a power good (PWGOOD) output. PWGOOD is the open drain of a MOSFET. Connect PWGOOD to Vin or another external voltage source less than 3.6V through a pull-up resistor. After applying the input voltage, the module turns on so that PWGOOD is pulled to GND before the soft start is ready. After the TRIM voltage reaches the threshold set internally, PWGOOD is pulled high after a delay.

When the converter encounters any fault (e.g.: UV, OV, OT, UVLO, etc.), PGOOD is latched low and cannot be pulled high again until a new soft start is initialized.

#### PMBus™ Alert (ALT#)

ALT# is active low. A pull-up resistor connected to 3.3V is required if the ALT# function is needed.

If any PMBus™ warnings appears, this terminal turn to High.

The CLEAR\_FAULTS command is used to reset all stored warning and fault flags.

See, Clear Faults command and any Warning commands, if need.

#### UVP/OVP Function

This product monitors a resistor divided feedback voltage to detect over and under voltage. When the feedback voltage becomes lower than 70% of the target voltage, after 1ms, the product turns OFF. The converter restarts after a hiccup delay (about 16ms). This function is enabled 1.5ms after the soft-start is completed.

When the feedback voltage becomes higher than 120% of the target voltage, the circuit operates sink-mode to decrease output voltage. If the output voltage reaches UV threshold, the device restarts after a hiccup delay. If the OV condition remains, the converter will not start until the OV condition is removed.

#### Remote On/Off Control

Please refer to the Connection Diagram on page 1 for On/Off connection. This converter is enabled when the On/Off pin is pulled high to Vin with respect to GND. This device is disabled when the On/Off pin is grounded or brought to within a low voltage (see Specifications) with respect to GND.

Dynamic control of the On/Off function should be able to sink appropriate signal current when brought low and withstand appropriate voltage when brought high. Be aware too that there is a finite time in milliseconds (see Specifications) between the time of On/Off Control activation and stable, regulated output. This time will vary slightly with output load type and current and input conditions.

#### Output Capacitive Load

Users should only consider adding capacitance to reduce switching noise and/or to handle spike current load steps. Install only enough capacitance to achieve noise objectives. Excess external capacitance may cause regulation problems, degraded transient response and possible oscillation or instability.

#### Soldering Guidelines

Murata recommends the specifications below when installing these converters. These specifications vary depending on the solder type. Exceeding these specifications may cause damage to the product. Your production environment may differ therefore please thoroughly review these guidelines with your process engineers.

This product can be reflowed once.

Reflow Solder Operations for surface-mount products	
For Sn/Ag/Cu based solders:	
Preheat Temperature	Less than 1degC per second
Time over Liquidus	45 to 75 seconds
Maximum Peak Temperature	250degC
Cooling Rate	Less than 3degC per second
For Sn/Pb based solders:	
Preheat Temperature	Less than 1degC per second
Time over Liquidus	60 to 75 seconds
Maximum Peak Temperature	235degC
Cooling Rate	Less than 3degC per second

**Recommended Lead-free Solder Reflow Profile**

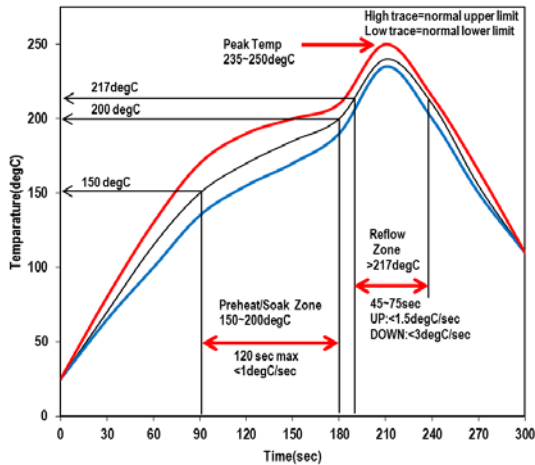

**CAUTION:** Do not reflow the converter as follows, because the converter may fall from the substrate during reflowing.

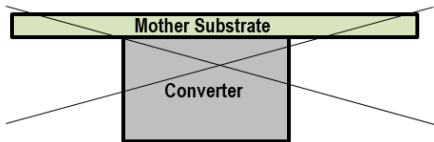

**Pb-free solder processes**

For Pb-free solder processes, the product is qualified for MSL 3 according to IPC/JEDEC standard J-STD-020D. During reflow PRODUCT must not exceed 250degC at any time.

**Dry Pack Information**

Products intended for Pb-free reflow soldering processes are delivered in standard moisture barrier bags according to IPC/JEDEC standard J-STD-033. (Handling, packing, shipping and use of moisture/reflow sensitivity surface mount devices.) Using products in high temperature Pb-free soldering processes requires dry pack storage and handling. In case the products have been stored in an uncontrolled environment and no longer can be considered dry, the modules must be baked according to J-STD-033.

**Output Voltage Adjustment**

This product provides output voltage monitoring through the register of READ\_VOUT (8Bh). In order to have correct output voltage setting and monitoring, the external voltage divider (RTrim) and the registers of VOUT\_COMMAND (21h), VOUT\_MARGIN\_HIGH (25h), VOUT\_MARGIN\_LOW (26h), VOUT\_SCALE\_LOOP (29h) should be set correspondingly. The following shows how to set the output voltage.

1. Determine the Rtrim value using following formula.

$$R_{trim} \text{ (kohm)} = 6 / (V_{out} - 0.6)$$

Then, connect an external trim resistor (Rtrim) between the Trim pin and GND pin. The Rtrim resistor must be a 1/10W precision metal film type, ±0.5% accuracy or better with low temperature coefficient, ±100 ppm/degC.

2. Set the VOUT\_COMMAND(21h) and the VOUT\_SCALE\_LOOP(29h) as follows.

VOUT\_COMMAND : Target Voltage in hexadecimal (Least Significant Bit is 0.002V)

VOUT\_SCALE\_LOOP: Set following value in hexadecimal  
VOUT\_SCALE\_VALUE= 0.6/Target Vout (Least Significant Bit is 0.001)

3. Set VOUT\_MARGIN\_HIGH (25h), VOUT\_MARGIN\_LOW (26h) as follows.

VOUT\_MARGIN\_HIGH (25h): Vout margin (high) voltage in hexadecimal. (Should be set in the range of 100~110% of target Vout)  
VOUT\_MARGIN\_LOW (26h): Vout margin (low) voltage in hexadecimal. (Should be set in the range of 90~100% of target Vout) (Least Significant Bit is 0.002V respectively)

The following table shows the RTrim and PMBus™ parameters at particular Vout for example.

Output Voltage	Estimated Rtrim (kohm)	PMBus™ Command Parameters			
		21h	29h	25h	26h
0.7V	30+30	0x015E (0.7V)	0x0359 (0.857)	0x0181 (0.77V)	0x013B (0.63V)
1.0V	15	0x01F4 (1.0V)	0x0258 (0.600)	0x0226 (1.1V)	0x01C2 (0.9V)
1.2V	10	0x0258 (1.2V)	0x01F4 (0.500)	0x0294 (1.32V)	0x021C (1.08V)
1.5V	4.7+2.0	0x02EE (1.5V)	0x0190 (0.400)	0x0339 (1.65V)	0x02A3 (1.35V)
1.8V	4.7+0.3	0x0384 (1.8V)	0x014D (0.333)	0x03DE (1.98V)	0x032A (1.62V)

**CAUTION**

It's not recommended to change PMBus™ parameters when the power stage is enabled. Proper operation of the converter is not guaranteed to do so.

Do not exceed the specified limits of the output voltage or the converter's maximum power rating when applying these resistors.

**Output Voltage Remote Sense**

This function is capable to compensate up the voltage drop between the output and input of load. The sense range depend on the maximum voltage allowing on the Vout Pin. The sense trace should be short as possible and shielded by GND line or else to reduce noise susceptibility. The sense line length is recommended within 10cm for output voltage stability. If the remote sense is not needed, Sense Pin should be connected to Vout PIN.

### PMBus™ Serial Interface Description

The Power Management Bus (PMBus™) is an open-standard, power-management protocol that defines a means of communication with power conversion and other devices.

The PMBus™ is a two-wire, bidirectional, serial interface, consisting of a data line (SDA) and a clock line (SCL). The lines are externally pulled to a bus voltage when they are idle. When connecting to the lines, a master device generates the SCL signal and device address and arranges the communication sequence. This is based on the I<sup>2</sup>C operation principles. This product is a PMBus™ slave which supports both the standard mode (100kHz) and fast modes (400kHz). The PMBus™ interface adds flexibility to the power supply solution.

### Multi Address

To support multiple devices used on the same PMBus™, use the ADDR pin or PMBus™ command D3h to program the different address for each device.

To determine the PMBus™ address through PMBus™, please refer to table about PMBus™ command D3h that is described following page.

To determine by external resistor, connect a resistor between ADDR pin and AGND to set the ADDR voltage. The internal ADC converts the pin voltage to set the PMBus™ address. Maximum 16 addresses can be set by ADDR pin. Following table shows the PMBus™ address for different resistor values from ADDR pin to AGND.

### Caution

Default setting, PMBus™ address is fixed "30h" internally not able to change by external resistor. If need to change by external resistor, please set D3h parameter by PMBus™.

R ADDR-GND(kohm)	ADDRESS
4.99	30h
15	31h
24.9	32h
34.8	33h
45.3	34h
54.9	35h
64.9	36h
75	37h
84.5	38h
95.3	39h
105	3Ah
115	3Bh
124	3Ch
133	3Dh
147	3Eh
154	3Fh

### Start and Stop Conditions

The start and stop are signaled by the master device which signifies the beginning and the end of the PMBus™ transfer.

The start condition is defined as the SDA signal transitioning from high to low while the SCL is high.

The STOP condition is defined as the SDA signal transitioning from low to high while the SCL is high as shown in Figure A.

The master then generates the SCL clocks, and transmits the device address and the read/write direction bit r/w on the SDA line. Data is transferred in 8 bit bytes by SDA line. Each byte of data is to be followed by an acknowledge bit.

### PMBus™ Update Sequence

This product requires a start condition, a valid PMBus™ address, a register address byte, and a data byte for a single data update.

The product acknowledges the receipt of each byte by pulling the SDA line low during the high period of a single clock pulse. A valid PMBus™ address selects the product.

The product performs an update on the falling edge of the LSB byte.

### Protocol Usage

All PMBus™ transactions on device are done using defined bus protocols. The following protocols are implemented:

- Send byte with PEC
- Receive byte with PEC
- Write byte with PEC
- Read byte with PEC
- Write word with PEC
- Read word with PEC
- Block read with PEC

**PMBus™ Bus message format**

In the tables in Figure B, unshaded cells indicate that the bus host is actively driving the bus; shaded cells indicate that the device is driving the bus.

- S = start condition
- Sr = repeated start condition
- P = stop condition
- R = read bit
- W= write bit
- A = acknowledge bit (0)
- A#= acknowledge bit (1)

"A" represents the ACK (acknowledge) bit. The ACK bit is typically active low (Logic 0) if the transmitted byte is successfully received by a device. However, when the receiving device is the bus master, the acknowledge bit for the last byte read is a logic 1, indicated by A#.

**Packet Error Checking (PEC)**

The device PMBus™ interface supports the use of the packet error checking (PEC) byte. The PEC byte is transmitted by the device during a read transaction or sent by the bus host to the device during a write transaction.

The PEC byte is used by the bus host or the device to detect errors during a bus transaction, depending on whether the transaction is a read or a write. If the host determines that the PEC byte read during a read transaction is incorrect, it can decide to repeat the read if necessary. If the device determines that the PEC byte sent during a write transaction is incorrect, it ignores the command (does not execute it) and sets a status flag. Within a group command, the host can choose to send or not send a PEC byte as part of the message to the device.

**PMBus™ Alert Response Address (ARA)**

The PMBus™ alert response address (ARA) is a special address that can be used by the bus host to locate any devices that need to talk to it. A host typically uses a hardware interrupt pin to monitor the PMBus™ ALERT pins of a number of devices. When a host interruption occurs, the host issues a message on the bus using the PMBus™ receive byte or receive byte with PEC protocol. The special address used by the host is 0x0C.

Any devices that have a PMBus™ alert signal return their own 7-bit address as the seven MSBs of the data byte. The LSB value is not used and can be either 1 or 0.

The host reads the device address from the received data byte and proceeds to handle the alert condition. More than one devices may have an active PMBus™ alert signal and attempt to communicate with the host. In this case, the device with the lowest address dominates the bus and succeeds in transmitting its address to the host. The device that succeeds disables its PMBus™ alert signal. If the host sees that the PMBus™ alert signal is still low, it continues to read addresses until all devices that need to talk to it have successfully transmitted their addresses.

**Data and Numerical Formats**

The device uses a direct format internally to represent real-world values such as voltage, current, power and temperature. All numbers with no suffix in this document are decimals unless explicitly designated otherwise. Numbers in binary format are indicated by the prefix "n'b", where n is the binary count. For example, 5'b01010 indicates a 5-bit binary data, and the data is 01010. The suffix "h" indicates a hexadecimal format, which is generally used for the register address number in this document. The symbol "0x" indicates a hexadecimal format, which is used for the value in the register. For example, 0xA3 is a 1-byte number whose hexadecimal value is A3.

**PMBus™ Communication Failure**

A data transmission fault occurs when the data is not properly transferred between the devices. There are several types of the data transmission faults as listed below:

- Sending too few data
- Reading too few data
- Sending too many bytes
- Reading too many bytes
- Improperly set read bit in the address byte
- Unsupported command code

**PMBus™ Reporting and Status Monitoring**

The device supports real-time monitoring for some operation parameters and status with PMBus™ interface. They are listed on following table.

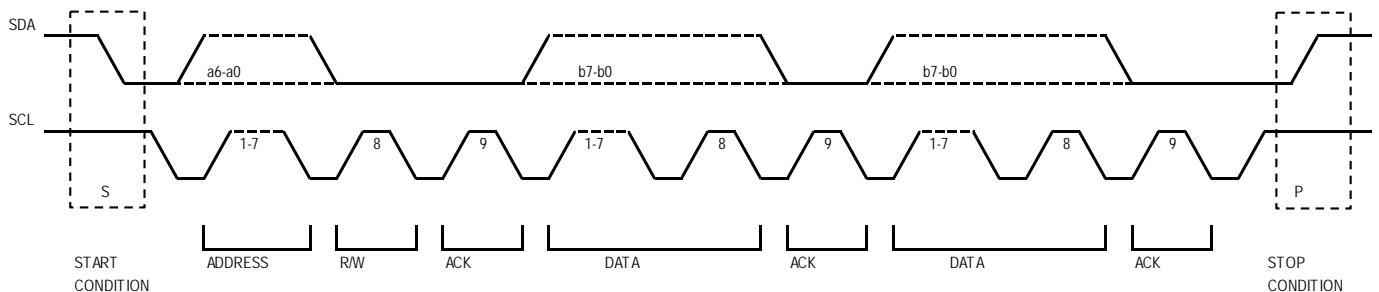
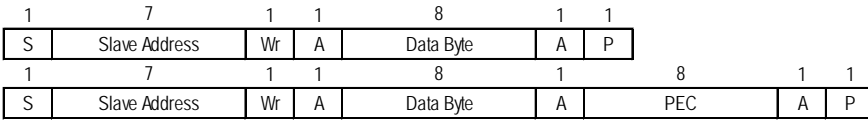

Figure. A

Communication Pattern

a) Send Byte and Send Byte with PEC



b) Receive Byte and Receive Byte with PEC

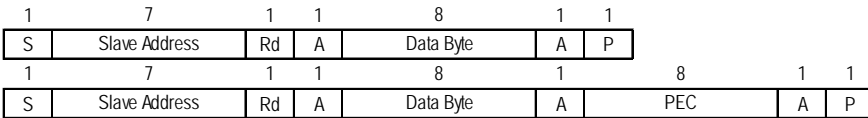

c) Write Byte and Write Byte with PEC

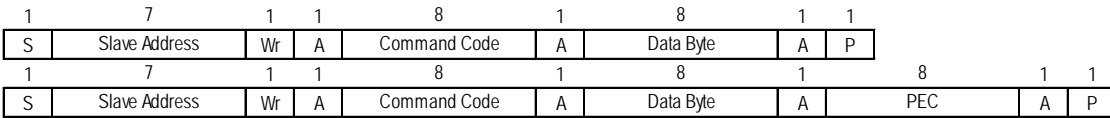

d) Write Word and Write Word with PEC

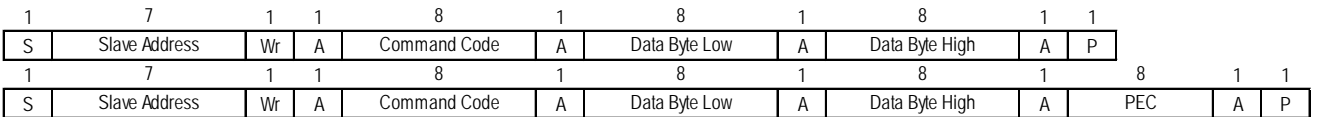

e) Read Byte and Read Byte with PEC

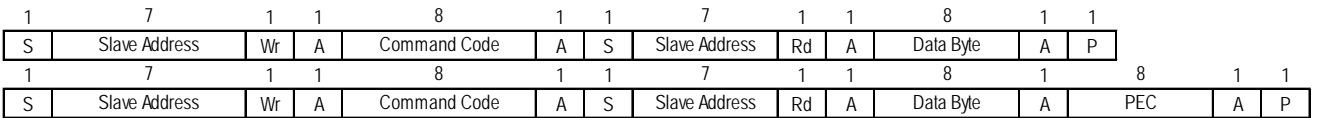

f) Read Word and Read Word with PEC

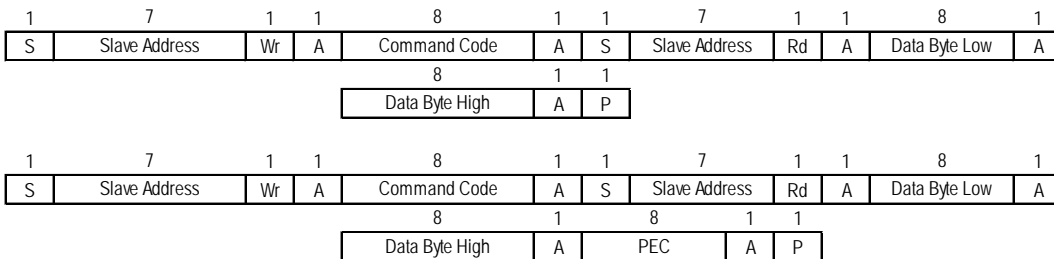

g) Block Read with PEC

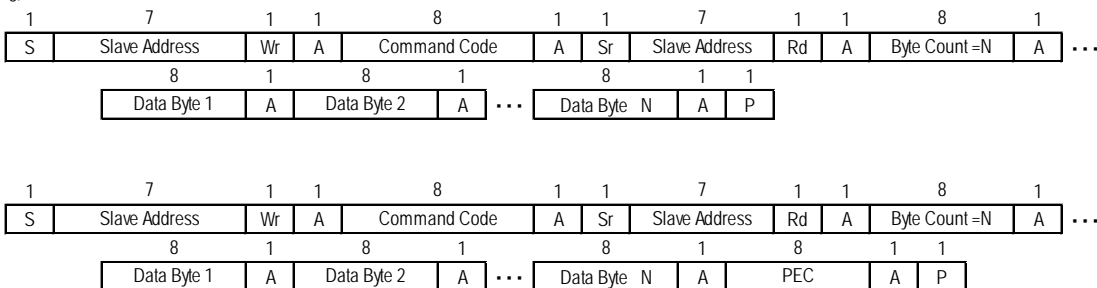

Figure B

## PMBus™ Register Map

The following table shows the PMBus™ command list

Code	Command Name	Type	Default Value (HEX)	Default Value (actual)
01h	OPERATION	R/W w/PEC	0x80	-
02h	ON_OFF_CONFIG	R/W w/PEC	0x16	-
03h	CLEAR_FAULTS	Send byte w/PEC	-	-
10h	WRITE_PROTECT	R/W w/PEC	0x00	-
19h	CAPABILITY	R w/PEC	0xB0	-
20h	VOUT_MODE	R w/PEC	0x40	-
21h	VOUT_COMMAND	R/W w/PEC	0x015E	0.7V
25h	VOUT_MARGIN_HIGH	R/W w/PEC	0x0181	0.77V
26h	VOUT_MARGIN_LOW	R/W w/PEC	0x013B	0.63V
29h	VOUT_SCALE_LOOP	R/W w/PEC	0x0359	0.857
35h	VIN_ON	R/W w/PEC	0x001D	7.25V
36h	VIN_OFF	R/W w/PEC	0x001B	6.75V
4Ah	IOUT_OC_WARN_LIMIT	R/W w/PEC	0x0050	19.36A
51h	OT_WARN_LIMIT	R/W w/PEC	0x0091	145degC
57h	VIN_OV_WARN_LIMIT	R/W w/PEC	0x0020	16V
58h	VIN_UV_WARN_LIMIT	R/W w/PEC	0x001C	7V
60h	TON_DELAY	R/W w/PEC	0x0000	0ms
61h	TON_RISE	R/W w/PEC	0x0001	2ms
78h	STATUS_BYTE	R/W w/PEC	-	-
79h	STATUS_WORD	R/W w/PEC	-	-
7Ah	STATUS_VOUT	R/W w/PEC	-	-
7Bh	STATUS_IOUT	R/W w/PEC	-	-
7Ch	STATUS_INPUT	R/W w/PEC	-	-
7Dh	STATUS_TEMPERATURE	R/W w/PEC	-	-
7Eh	STATUS_CML	R/W w/PEC	-	-
88h	READ_VIN	R w/PEC	-	-
8Bh	READ_VOUT	R w/PEC	-	-
8Ch	READ_IOUT	R w/PEC	-	-
8Dh	READ_TEMPERATURE_1	R w/PEC	-	-
98h	PMBUS_REVISION	R/W w/PEC	-	-
D1h	MFR_CTRL_VOUT	R/W w/PEC	0x00	-
D3h	MFR_ADDR_PMBUS	R/W w/PEC	0xB0	-

### OPERATION (01h)

OPERATION is a paged register. The OPERATION command is used to turn the converter output on or off in conjunction with the input from the CTRL pin. OPERATION is also used to set the output voltage to the upper or lower margin voltages. The unit remains in the commanded operating mode until a subsequent OPERATION command or a change in the state of the CTRL pin instructs the converter to change to another mode. This OPERATION command is also used to re-enable the converter after a fault-triggered shutdown. Writing an off command followed by an on command clears all faults. Writing only an on command after a fault-triggered shutdown will not clear the fault registers.

Command	OPERATION							
Format	Unsigned binary							
Bit	7	6	5	4	3	2	1	0
Access	r/w	r/w	r/w	r/w	r/w	r/w	r	r
Function							x	x
Default Value	1	0	0	0	0	0	x	x



Bit[7:6]	Bit[5:4]	Bit[3:2]	Bit[1:0]	On/Off	Margin state	01h
00	xx	xx	xx	Immediate off	N/A	0x00
01	xx	xx	xx	Immediate off	N/A	0x60
10	00	xx	xx	on	off	0x80
10	01	01	xx	on	Margin low (ignore fault)	0x94
10	01	10	xx	on	Margin low (act on fault)	0x98
10	10	01	xx	on	Margin high (ignore fault)	0xA4
10	10	10	xx	on	Margin high (act on fault)	0xA8

### ON\_OFF\_CONFIG (02h)

The ON\_OFF\_CONFIG command configures the combination of the CTRL input and the PMBus™ commands to turn the converter on and off. This includes how the converter responds when an input voltage is applied.

Command	ON_OFF_CONFIG							
Format	Unsigned binary							
Bit	7	6	5	4	3	2	1	0
Access	r	r	r	r/w	r/w	r/w	r/w	r
Function	x	x	x	on	op	ctrl	x	delay
Default Value	0	0	0	1	0	1	1	0

### on

This on bit sets the default to either operate whenever the input voltage is present or for the on/off to be controlled by CTRL and PMBus™ commands.

Bit[4] Value	Meaning
0	Converter powers up whenever the input voltage is present regardless of state of the CTRL pin
1	Converter does not power up until commanded by the CTRL pin and OPERATION command (as programmed in bits[3:0])

### op

This op bit controls how the converter responds to the OPERATION commands.

Bit[3] Value	Meaning
0	Converter ignores the “on” bit in the OPERATION command from PMBus™
1	Converter responds the “on” bit in the OPERATION command from PMBus™

### ctrl

This ctrl bit controls how the converter responds to the CTRL pin.

Bit[2] Value	Meaning
0	Converter ignores the CTRL pin (on/off controlled only by the OPERATION command)
1	Converter requires the CTRL pin to be asserted to power up. Depending on bit[3] op bit, the OPERATION command may also be required to instruct the converter to power up.

### delay

This delay bit sets the turn-off action when the converter is commanded off through the PMBus™. This bit is read only and cannot be modified by the end user.

Bit[0] Value	Meaning
0	TOFF_DELAY, TOFF_FALL

### CLEAR\_FAULTS (03h)

The CLEAR\_FAULTS command is used to reset all stored warning and fault flags. If a fault or warning condition still remains when the CLEAR\_FAULTS command is issued, the ALT# signal may not be cleared or is reasserted almost immediately. Issuing a CLEAR\_FAULTS command will not cause the converter to restart in the event of a fault turn-off. The converter restart must be done by issuing an OPERATION command after the fault condition is cleared. This command uses the PMBus™ to send the byte protocol.

### WRITE\_PROTECT (10h)

The WRITE\_PROTECT command is used to control writes to the converter. This command provides protection against accidental changes. This command is not intended to provide protection against deliberate or malicious changes to the converter's configuration or operation. All the supported commands may have their parameters read, regardless of the WRITE\_PROTECT settings.

Bit[7:0] Value	Meaning
0 0 0 0 0 0 0 0	Enable writes to all commands
0 0 1 0 0 0 0 0	Disable all writes except to the WRITE_PROTECT, OPERATION, PAGE, ON_OFF_CONFIG and VOUT_COMMAND commands
0 1 0 0 0 0 0 0	Disable all writes except to the WRITE_PROTECT, OPERATION and PAGE commands
1 0 0 0 0 0 0 0	Disable all writes except to the WRITE_PROTECT command

### CAPABILITY (19h)

The CAPABILITY command returns information about the PMBus™ functions supported by this product. This command is read with the PMBus™ read byte protocol.

Command	CAPABILITY							
Format	Unsigned binary							
Bit	7	6	5	4	3	2	1	0
Access	r	r	r	r	r	r	r	r
Function	PEC	MAX bus speed	Alert	x	x	x	x	
Default Value	1	0	1	1	0	0	0	0

Bit[6:5] Value	Meaning
0 0	Maximum supported bus speed is 100KHz
1 0	Maximum supported bus speed is 400KHz
1 1	Reserved
0 1	Not supported

### VOUT\_MODE (20h)

The VOUT\_MODE command is used to command and read the output voltage. The three most significant bits are used to determine the data format (only direct format is supported in this product), and the rest of five bits represent the exponent used in the output voltage Read/Write commands. The default value of 20h is 0x40.

### VOUT\_COMMAND (21h)

The VOUT\_COMMAND sets the output voltage of this product. The VOUT\_COMMAND and VOUT\_SCALE\_LOOP together determine the feedback reference voltage: VOUT\_COMMAND x VOUT\_SCALE\_LOOP. In the section of "Output Voltage Setting" on page 28, it shows the details about how to set the output voltage.

The value is unsigned and 1LSB = 2mV. The default value of 21h is 0x015E, which is 0.7V.

Command	VOUT_COMMAND															
Format	Direct															
Bit	15	14	13	12	11	10	9	8	7	6	5	4	3	2	1	0
Access	r	r	r	r	r/w	r/w	r/w	r/w	r/w	r/w	r/w	r/w	r/w	r/w	r/w	r/w
Function	x								2mV/LSB							
Default Value	0	0	0	0	0	0	0	1	0	1	0	1	1	1	1	0

**VOUT\_MARGIN\_HIGH (25h)**

Command	VOUT_MARGIN_HIGH															
Format	Direct															
Bit	15	14	13	12	11	10	9	8	7	6	5	4	3	2	1	0
Access	r	r	r	r	r/w	r/w	r/w	r/w	r/w	r/w	r/w	r/w	r/w	r/w	r/w	r/w
Function	x				2mV/LSB											
Default Value	0	0	0	0	0	0	0	1	1	0	0	0	0	0	0	1

The value is unsigned and 1LSB = 2mV. The default value is 0.77V. So the default value of 25h is 0x0181.

**VOUT\_MARGIN\_LOW (26h)**

Command	VOUT_MARGIN_LOW															
Format	Direct															
Bit	15	14	13	12	11	10	9	8	7	6	5	4	3	2	1	0
Access	r	r	r	r	r/w	r/w	r/w	r/w	r/w	r/w	r/w	r/w	r/w	r/w	r/w	r/w
Function	x				2mV/LSB											
Default Value	0	0	0	0	0	0	0	1	0	0	1	1	1	0	1	1

The value is unsigned and 1LSB = 2mV. The default value is 0.63V. So the default value of 26h is 0x013B.

**VOUT\_SCALE\_LOOP (29h)**

VOUT\_SCALE\_LOOP sets the feedback resistor divider ratio and is equal to VFB/VOUT. Regardless of whether an external or internal feedback resistor divider is used, VOUT\_SCALE\_LOOP should match the actual feedback resistor divider used.

Command	VOUT_SCALE_LOOP															
Format	Direct															
Bit	15	14	13	12	11	10	9	8	7	6	5	4	3	2	1	0
Access	r	r	r	r	r/w	r/w	r/w	r/w	r/w	r/w	r/w	r/w	r/w	r/w	r/w	r/w
Function	x				0.001/LSB											
Default Value	0	0	0	0	0	0	1	1	0	1	0	1	1	0	0	1

The value is unsigned and 1LSB = 0.001. The default value is 0.857. So the default value of 29h is 0x0359.

**VIN\_ON (35h)**

The VIN\_ON command sets the value of the input voltage, (in V), at which the converter should start to run if all other required power-up conditions are met. The VIN\_ON value can be set between 7.5V and 15V with 0.25V increment. The VIN\_ON value should be always set higher than VIN\_OFF value with enough margin, so that there will be no bouncing between VIN\_ON and VIN\_OFF during power conversion.

Command	VIN_ON															
Format	Direct															
Bit	15	14	13	12	11	10	9	8	7	6	5	4	3	2	1	0
Access	r	r	r	r	r/w	r/w	r/w	r/w	r/w	r/w	r/w	r/w	r/w	r/w	r/w	r/w
Function	x				250mV/LSB											
Default Value	0	0	0	0	0	0	0	0	0	0	0	1	1	1	0	1

The value is unsigned and 1LSB=250mV. The default value is 7.25V. So the default value of 35h is 0x001D.

**VIN\_OFF (36h)**

The VIN\_OFF command sets the value of the input voltage, (in V), at which the converter, once operation has started, should stop power conversion. The VIN\_OFF value can be set between 7.25V and 14.75V with 0.25V increment. The VIN\_OFF value should be always set lower than VIN\_ON value with enough margin, so that there is no bouncing between VIN\_OFF and VIN\_ON during power conversion.

Command	VIN_OFF															
Format	Direct															
Bit	15	14	13	12	11	10	9	8	7	6	5	4	3	2	1	0
Access	r	r	r	r	r/w	r/w	r/w	r/w	r/w	r/w	r/w	r/w	r/w	r/w	r/w	r/w
Function	x				250mV/LSB											
Default Value	0	0	0	0	0	0	0	0	0	0	0	1	1	0	1	1

The value is unsigned and 1LSB=250mV. The default value is 6.75V. So the default value of 36h is 0x001B.

### IOUT\_OC\_WARN\_LIMIT (4Ah)

The IOUT\_OC\_WARN\_LIMIT command is used to configure or read the threshold for the over-current warning detection. If the sensed current exceeds this value, the OC warning flags are set in the STATUS\_BYTE (78h), STATUS\_WORD (79h) respectively, and the ALT# signal is asserted.

Command	IOUT_OC_WARN_LIMIT															
Format	Direct															
Bit	15	14	13	12	11	10	9	8	7	6	5	4	3	2	1	0
Access	r	r	r	r	r/w	r/w	r/w	r/w	r/w	r/w	r/w	r/w	r/w	r/w	r/w	r/w
Function	x				242mA/LSB											
Default Value	0	0	0	0	0	0	0	0	0	0	1	0	1	0	0	0

The value is unsigned and 1LSB=242mA. The default value is 0050h. The corresponding value of the total output current is about 19.4A.

### OT\_WARN\_LIMIT (51h)

The OT\_WARN\_LIMIT is used to configure or read the threshold for the over-temperature warning detection. If the sensed temperature exceeds this value, an over temperature warning is triggered, the OT warning flags are set in the STATUS\_BYTE(78h) and STATUS\_WORD(79h) respectively, and the ALT# signal is asserted. The minimum temperature warning detection time should be smaller than 20ms.

Command	OT_WARN_LIMIT															
Format	Direct															
Bit	15	14	13	12	11	10	9	8	7	6	5	4	3	2	1	0
Access	r	r	r	r	r	r	r	r	r	r/w	r/w	r/w	r/w	r/w	r/w	r/w
Function	x								1degC/LSB							
Default Value	0	0	0	0	0	0	0	0	1	0	0	1	0	0	0	1

The value is unsigned and 1LSB=1 degC. The default value is 0x0091h. The corresponding value is 145degC. The OT\_WARN\_LIMIT setting value should be lower than 155degC.

### VIN\_OV\_WARN\_LIMIT (57h)

The VIN\_OV\_WARN\_LIMIT command is used to configure or read the threshold for the input-over-voltage warning detection. If the measured value of VIN rises above the value in this register, VIN OV warning flags are set in the respective registers, and the ALT# signal is asserted.

Command	VIN_OV_WARN_LIMIT															
Format	Direct															
Bit	15	14	13	12	11	10	9	8	7	6	5	4	3	2	1	0
Access	r	r	r	r	r/w	r/w	r/w	r/w	r/w	r/w	r/w	r/w	r/w	r/w	r/w	r/w
Function	x				500mV/LSB											
Default Value	0	0	0	0	0	0	0	0	0	0	0	1	0	0	0	0

The value is unsigned and 1LSB=500mV. The default value is 0x20. The corresponding value is 16V. The VIN\_OV\_WARN\_LIMIT setting value should not be higher than 16V.

### VIN\_UV\_WARN\_LIMIT (58h)

The VIN\_UV\_WARN\_LIMIT command is used to configure or read the threshold for the input-under-voltage warning detection. If the measured value of VIN falls below the value in this register, VIN UV warning flags are set in the respective registers, and the ALT# signal is asserted.

Command	VIN_UV_WARN_LIMIT															
Format	Direct															
Bit	15	14	13	12	11	10	9	8	7	6	5	4	3	2	1	0
Access	r	r	r	r	r/w	r/w	r/w	r/w	r/w	r/w	r/w	r/w	r/w	r/w	r/w	r/w
Function	x				250mV/LSB											
Default Value	0	0	0	0	0	0	0	0	0	0	0	0	1	1	1	0

The value is unsigned and 1LSB=250mV. The default value is 0x1C. The corresponding value is 7.0V. The VIN\_UV\_WARN\_LIMIT setting value should be higher than 7.0V.

### TON\_DELAY (60h)

The TON\_DELAY command sets the time, (in ms), from when a start condition is received (as programmed by the ON\_OFF\_CONFIG command) until the output voltage starts to rise.

Command	TON_DELAY															
Format	Direct															
Bit	15	14	13	12	11	10	9	8	7	6	5	4	3	2	1	0
Access	r	r	r	r	r	r/w	r/w	r/w	r/w	r/w	r/w	r/w	r/w	r/w	r/w	r/w
Function	x					4ms/LSB										
Default Value	0	0	0	0	0	0	0	0	0	0	0	0	0	0	0	0

The value is unsigned and 1LSB=4ms. The maximum value is 60h=0x0100 (1024ms). The default value is 0x0000 (0ms).

### TON\_RISE (61h)

The TON\_RISE command sets the soft-start time, (in ms), from when the output starts to rise until the voltage has reached the regulation point.

Command	TON_RISE															
Format	Direct															
Bit	15	14	13	12	11	10	9	8	7	6	5	4	3	2	1	0
Access	r	r	r	r	r/w	r/w	r/w	r/w	r/w	r/w	r/w	r/w	r/w	r/w	r/w	r/w
Function	x															
Default Value	0	0	0	0	0	0	0	0	0	0	0	0	0	0	0	1

The only supported values are as follows:

3'b000: 1ms

3'b001: 2ms

3'b010: 4ms

3'b011: 8ms

3'b100 and up: 16ms.

The default value is 0x0001, i.e. 2ms for soft-start time.

### STATUS BYTE (78h)

The STATUS\_BYTE command returns the value of a number of flags indicating the state of this product. Accesses to this command should use the read byte protocol. To clear bits in this register, the underlying fault should be removed and a CLEAR\_FAULTS command issued.

Bits	Name	Behavior	Default	Description
[7]	Reserved		0	Always read as 0.
[6]	OFF	Live	0	0:product enabled 1:product disabled, this can be from: the OC fault, the OT fault, the bad MOSFET fault, the UV/OV fault, or the OPERATION command turning off
[5]	VOUT_OV		0	An output overvoltage fault has occurred.
[4]	Iout_OC_FAULT	Latched	0	0:no over current fault detected 1:over current fault detected
[3]	VIN_UV		0	Not supported, always read as 0
[2]	OT_FAULT_WARN	Live	0	0:no over temperature warning or fault detected 1:over temperature warning or fault detected
[1]	CUMM_ERROR	Latched	0	0:no communication error detected 1:communication error detected
[0]	NONE_OF_THE_ABOVE	Live	0	0:no other fault or warning 1:fault or warning not listed in bits [7:1] has occurred.

### STATUS\_WORD (79h)

The STATUS\_WORD returns the value of a number of flags indicating the state of this product. To clear bits in this register, the underlying fault should be removed and a CLEAR\_FAULTS command issued.

Bits	Name	Behavior	Default	Description
[15]	VOUT_STATUS	Live	0	0:no output fault or warning 1:output fault or warning
[14]	IOUT_STATUS	Live	0	0:no lout fault 1:lout falut
[13]	VIN_STATUS	Live	0	0:no Vn Fault 1:Vin Fault, at the period when Vin starts up, the initial flag is 1 before Vin pass UVLO threshold. The flag cleared once Vin passes UVLO.
[12]	MFR_STATUS		0	Always read as 0
[11]	POWETR_GOOD#	Live	0	0:power good signal is asserted 1:power good signal is not asserted
[10]	Reserved		0	Always read as 0
[9]	Reserved		0	Always read as 0
[8]	UNKNOWN	Latched	0	0:no any other fault has occurred 1:a fault type not specified in bits [15:1] of the STATUS_WORD has been detected.
Low Byte	STATUS_BYTE			STATUS_BYTE is the low byte of the STATUS_WORD.

### STATUS\_VOUT (7Ah)

The STATUS\_VOUT command returns one data byte with contents as follows:

Bits	Name	Behavior	Default	Description
[7]	VOUT_OV_FAULT	Live	0	0:no output OV fault 1:output OV fault
[6]	Reserved	Latched	0	Always read as 0
[5]	Reserved	Latched	0	Always read as 0
[4]	VOUT_UV_FAULT	Live	0	0:no output UV fault 1:output UV fault
[3]	VOUT_MAX_MIN	Live	0	0:no VOUT_MAX, VOUT_MIN warning 1:an attempt has been made to set the output voltage to a value higher than allowed by the VOUT_MAX command or lower than the limit allowed by the VOUT_MIN command.
[2]	Reserved		0	Always read as 0
[1]	Reserved		0	Always read as 0
[0]	UNKNOWN	Latched	0	0:no any other fault has occurred 1:a fault type not specified in bits [15:1] of the STATUS_WORD has been detected.

### STATUS\_IOUT (7Bh)

Command	STATUS_IOUT							
Format	Unsigned binary							
Bit	7	6	5	4	3	2	1	0
Access	r	r	r	r	r	r	r	r
Function	IOUT_OC	IOUT_OC & VOUT_UV	IOUT_OC_WARNING	x	x	x	x	x
Default Value	0	0	0	0	0	0	0	0



### STATUS\_INPUT (7Ch)

The STATUS\_INPUT returns the value of flags indicating input voltage status of this product. To clear bits in this register, the underlying fault or warning should be removed and a CLEAR\_FAULTS command issued.

Bits	Name	Behavior	Default	Description
[7]	VIN_OV_FAULT	R, Latched	0	0:no Over voltage detected on the OV pin 1:over voltage detected on the OV pin
[6]	VIN_OV_WARN	R, Latched	0	0:over voltage condition on VIN has not occurred 1:over voltage condition on VIN has occurred
[5]	VIN_UV_WARN	R, Latched	0	0:under voltage condition on VIN has not occurred 1:under voltage condition on VIN has occurred
[4:0]	Reserved		0	Always read as 00000

### STATUS\_TEMPERATURE (7Dh)

The STATUS\_TEMPERATURE returns the value of flags indicating the VIN overvoltage or under-voltage of this product. To clear bits in this register, the underlying fault should be removed and a CLEAR\_FAULTS command issued.

Bits	Name	Behavior	Default	Description
[7]	OT_FAULT	R, Latched	0	1:over-temperature Warning has occurred
[6]	OT_WARNING	R, Latched	0	1:over-temperature Warning has occurred
[5:0]	Reserved	R	0	Always read as 0

### STATUS\_CML (7Eh)

Command	STATUS_CML							
Format	Unsigned binary							
Bit	7	6	5	4	3	2	1	0
Access	r	r	r	r	r	r	r	r
Function	Invalid unsupported command	Invalid / unsupported data	x	Memory fault detected	x	x	Other fault	Memory busy
Default Value	0	0	0	0	0	0	0	0

### READ\_VIN (88h)

The READ\_VIN command returns the 10-bit measured value of the input voltage.

Command	READ_VIN															
Format	Direct															
Bit	15	14	13	12	11	10	9	8	7	6	5	4	3	2	1	0
Access	r	r	r	r	r	r	r	r	r	r	r	r	r	r	r	r
Function	x						25mV/LSB									
Default Value	0	0	0	0	0	0	0	0	0	0	0	0	0	0	0	0

### READ\_VOUT (8Bh)

The READ\_VOUT command returns the 10-bit measured value of the output voltage.

Command	READ_VOUT															
Format	Direct															
Bit	15	14	13	12	11	10	9	8	7	6	5	4	3	2	1	0
Access	r	r	r	r	r	r	r	r	r	r	r	r	r	r	r	r
Function	x						1.25mV/LSB									
Default Value	0	0	0	0	0	0	0	0	0	0	0	0	0	0	0	0

### READ\_IOUT (8Ch)

The READ\_IOUT command returns the 10-bit measured value of the output current. This value is also used to compare with the IOUT\_OC\_FAULT\_LIMIT and IOUT\_OC\_WARN\_LIMIT, and then affects the STATUS\_IOUT.

Command	READ_IOUT															
Format	Direct															
Bit	15	14	13	12	11	10	9	8	7	6	5	4	3	2	1	0
Access	r	r	r	r	r	r	r	r	r	r	r	r	r	r	r	r
Function	x							62.5mALSB								
Default Value	0	0	0	0	0	0	0	0	0	0	0	0	0	0	0	0

### READ\_TEMPERATURE\_1 (8Dh)

The READ\_TEMPERATURE\_1 command returns the internal sensed temperature. This value is also used internally for the Over Temperature Fault and Warning detection. This data has a range of -255degC to +255degC.

Command	READ_TEMPERATURE_1															
Format	Direct															
Bit	15	14	13	12	11	10	9	8	7	6	5	4	3	2	1	0
Access	r	r	r	r	r	r	r	r	r	r	r	r	r	r	r	r
Function	x							Sign	1degC/LSB							
Default Value	0	0	0	0	0	0	0	0	0	0	0	0	0	0	0	0

READ\_TEMPERATURE\_1 is a 2-byte, twos complement integer. The bit9 is the sign bit. Below table shows the relationship between direct value and real word value.

Sing	Direct Value	Real Value degC
0	0 0000 0000	0
0	0 0000 0001	1
0	1 1111 1111	+511
1	0 0000 0000	-511
1	1 1111 1111	-1

### PMBUS\_REVISION (98h)

The PMBUS\_REVISION command returns the protocol revision we used. Accesses to this command should use the read byte protocol. Bits [7:4] indicate the PMBus™ revision of specification Part I to which the device is compliant. Bits [3:0] indicate the revision of specification Part II to which the device is compliant.

Command	PMBus™_REVISION							
Format	Unsigned binary							
Bit	7	6	5	4	3	2	1	0
Access	r	r	r	r	r	r	r	r
Default Value	0	0	1	1	0	0	1	1

Bits [7:4] always reads as 4'b0011, specification PMBus™ Part I Revision 1.3.

Bits [3:0] always reads as 4'b0011, specification PMBus™ Part II Revision 1.3.

### MFR\_CTRL\_VOUT (D1h)

The MFR\_CTRL\_VOUT command is used to adjust the output voltage behaviors of this product.

Bits	Name	Behavior	Default	Description
[7]	Reserved	Live	0	N/A
[6]	Vo Discharge	Live	0	1:output voltage discharge at CTRL low. 0:no active output voltage discharge.
[5:0]	Reserved	Live	0	N/A

Bit[6] (Vo discharge): Enable or disable active output voltage discharge when this product is commanded off through CTRL or the OPERATION command.

MFR\_ADDR\_PMBUS (D3h)

Command	MFR_ADDR_PMBus							
Format	Direct							
Bit	7	6	5	4	3	2	1	0
Access	r/w	r/w	r/w	r/w	r/w	r/w	r/w	r/w
Function	Enable	ADDR						
Default Value	1	0	1	1	0	0	0	0

Bit[7] (enable bit):

1: the address is decided by MFR\_ADDR\_PMBUS [6:0].

0: the address is decided by ADDR pin.

The default value of D3h is 0xB0.

APPENDIX

Test Circuit

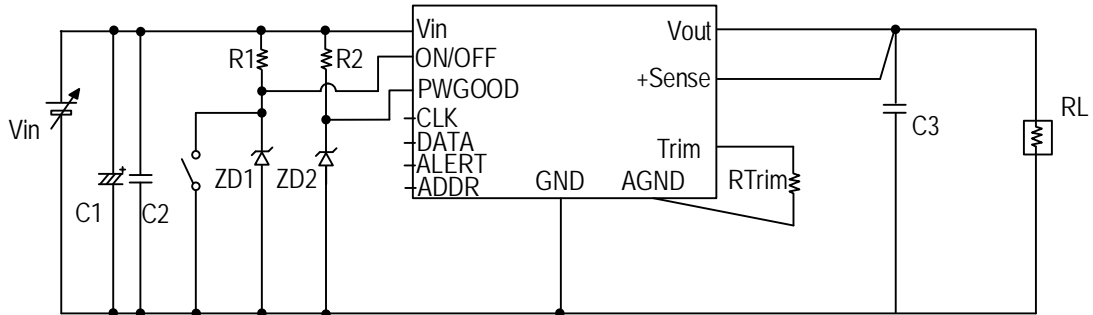

Vin : DC Power Supply  
RL : Electronic Load Device

- C1 : 1000 $\mu$ F/25V  $\times$  1pc Electrolysis Capacitor
- C2 : 22 $\mu$ F/25V  $\times$  2pcs (GRM32ER71E226KE15 : Murata)
- C3 : 220 $\mu$ F/4V  $\times$  3pcs (GRM32EC80G227ME05 : Murata)
- R1, R2 : 4.7k (+/- 5%, 1/10W)
- ZD1, ZD2 : EDZVT2R3.3B (ROHM)

Do not connect any additional components between the Trim pin and Vout or between the Trim and Sense pins. Use only the specified connections.  
If there is a long inductive cable length between the input power source and converter, then some additional bulk decoupling capacitance (eg. up to 1000uF) may be necessary to ensure a low AC impedance power source. This would typically be aluminum electrolytic type and does not need to be close to the input terminals of converter.

This product uses technology licensed from PAI CAPITAL, protected by following patents.  
US8086874, US7882372, US7836322, US7782029, US7743266, US7737961, US7673157, US7646382, US7583487, US7565559, US7554778, US7526660, US7493504, US7459892, US7456617, US7394445, US7373527, US7372682, US7315156, US7266709, US7249267, US7080265, US7068021, US7049798, US7000125, US6949916, US6936999, US6788036, CA2694295A1, CN100371856C, CN100452610C, CN100459360C, CN100465848C, CN1069332A, CN11124619A, CN100458656C, CN1685582B, CN101416138B, ZL200880107236.8, CN101346682B, EP1561156A1, EP1561568B8, EP1576710A1, EP1576711B1, EP1604254A4, EP1604264A4, EP1714369A2, EP1745536A4, EP2183656A1, EP1899789A2, EP1984801A2, JP5081303B1, KR100796074B1, KR101017774B1, KR10-1143133B1, WO2004062062A1, WO2004044718A1, WO2004045042A3, WO2004045042C1, WO2004062061A1, WO2004070780A3, WO2004084390A3, WO2004084391A3, WO2005079227A3, WO2005081771A3, WO2006019569A3, WO2007001584, WO2007094935



This product is subject to the following [operating requirements](#) and the [Life and Safety Critical Application Sales Policy](#):  
Refer to: <https://power.murata.com/en/requirements>

Murata Manufacturing Co., Ltd makes no representation that the use of its products in the circuits described herein, or the use of other technical information contained herein, will not infringe upon existing or future patent rights. The descriptions contained herein do not imply the granting of licenses to make, use, or sell equipment constructed in accordance therewith. Spec and cautions are subject to change without notice. © 2018 Murata Manufacturing Co., Ltd

## X-ON Electronics

Largest Supplier of Electrical and Electronic Components

*Click to view similar products for [Non-Isolated DC/DC Converters](#) category:*

*Click to view products by [Murata](#) manufacturer:*

Other Similar products are found below :

[PSR152.5-7IR](#) [APTH003A0X-SRZ](#) [SPM1004-3V3C](#) [R-785.0-05](#) [10E24-P15-10PPM](#) [1E24-P4-25PPM-SHV-5KV](#) [PROPOWER-3.3V](#)  
[MYGTM01210BZN](#) [JRCS016A0S4-HZ](#) [40C24-N250-I5-H](#) [10C24-N250-I10-AQ-DA](#) [4AA24-P20-M-H](#) [3V12-N0.8](#) [3V24-P1](#) [3V24-N1](#)  
[BMR4672010/001](#) [BMR4652010/001](#) [T31SN12008NMFA](#) [6AA24-P30-I5-M](#) [6AA24-N30-I5-M](#) [BM2P101X-Z](#) [ROF-78E12-0.5SMD-R](#)  
[RPMA5.0-8.0/OF](#) [PTV03010WAD](#) [PTV05020WAH](#) [PTV12010LAH](#) [PTV12020WAD](#) [R-7212D](#) [R-7212P](#) [R-78AA5.0-1.0SMD](#) [30A24-](#)  
[N15-E](#) [10A12-P4-M](#) [10C24-N250-I5](#) [10C24-P125](#) [10C24-P250-I5](#) [6A24-P20-I10-F-M-25PPM](#) [1A24-P30-F-M-C](#) [TSR 1-24150SM](#)  
[1/2AA24-N30-I10](#) [1C24-N125](#) [12C24-N250](#) [V7806-1500](#) [PTV12020LAH](#) [PTV05010WAH](#) [PTN04050CAZT](#) [PTH12020WAD](#)  
[PTH12020LAS](#) [PTH05050YAH](#) [PTH05T210WAH](#) [PTH05030WAZ](#)