

**CHIP EMIFIL®CHIP 3-TERMINAL CAPACITOR ARRAY TYPE FOR GENERAL
NFA31GD Series**

Reference Sheet

1.Scope

This product specification is applied to Chip EMIFIL®Chip 3-terminal Capacitor Array Type used for General Electronic equipment.

2.Reference PART No. List

	Customer PART NO.	MURATA PART NO.
1		NFA31GD1016R84D
2		NFA31GD1014704D
3		NFA31GD1011014D
4		NFA31GD1006R84D
5		NFA31GD1004704D
6		NFA31GD1001014D
7		NFA31GD4706R84D
8		NFA31GD4703304D
9		NFA31GD4704704D
10		NFA31GD4701014D

3.MURATA Part NO. System

(Ex.)

NFA	31	GD	101	6R8	4	D
-----	----	----	-----	-----	---	---

(1)L/W Dimensions (2)Features (3)Nominal Capacitance (4)Registance (5)Number of Circuits (6)Packaging Code

4. Type & Dimensions

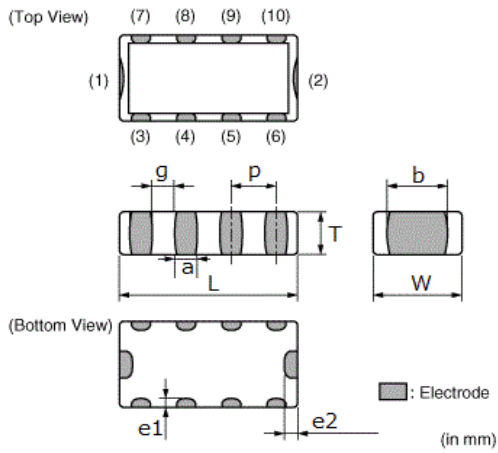

(Unit:mm)

MURATA PART NO.	(1)-1 L	W1	T	g	
	a	b	e1	e2	p
1 NFA31GD1016R84D	3.2±0.2	1.6±0.2	0.8±0.2	0.1 min.	
	0.4±0.15	1.1±0.5	0.05 min.	0.05 min.	0.8±0.1
2 NFA31GD1014704D	3.2±0.2	1.6±0.2	0.8±0.2	0.1 min.	
	0.4±0.15	1.1±0.5	0.05 min.	0.05 min.	0.8±0.1
3 NFA31GD1011014D	3.2±0.2	1.6±0.2	0.8±0.2	0.1 min.	
	0.4±0.15	1.1±0.5	0.05 min.	0.05 min.	0.8±0.1
4 NFA31GD1006R84D	3.2±0.2	1.6±0.2	0.8±0.2	0.1 min.	
	0.4±0.15	1.1±0.5	0.05 min.	0.05 min.	0.8±0.1
5 NFA31GD1004704D	3.2±0.2	1.6±0.2	0.8±0.2	0.1 min.	
	0.4±0.15	1.1±0.5	0.05 min.	0.05 min.	0.8±0.1
6 NFA31GD1001014D	3.2±0.2	1.6±0.2	0.8±0.2	0.1 min.	
	0.4±0.15	1.1±0.5	0.05 min.	0.05 min.	0.8±0.1
7 NFA31GD4706R84D	3.2±0.2	1.6±0.2	0.8±0.2	0.1 min.	
	0.4±0.15	1.1±0.5	0.05 min.	0.05 min.	0.8±0.1
8 NFA31GD4703304D	3.2±0.2	1.6±0.2	0.8±0.2	0.1 min.	
	0.4±0.15	1.1±0.5	0.05 min.	0.05 min.	0.8±0.1
9 NFA31GD4704704D	3.2±0.2	1.6±0.2	0.8±0.2	0.1 min.	
	0.4±0.15	1.1±0.5	0.05 min.	0.05 min.	0.8±0.1
10 NFA31GD4701014D	3.2±0.2	1.6±0.2	0.8±0.2	0.1 min.	
	0.4±0.15	1.1±0.5	0.05 min.	0.05 min.	0.8±0.1

a)Equivalent Circuit

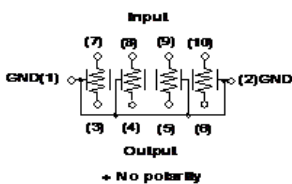

5. Rated value

	MURATA PART NO.	(3) Nominal Capacitance	Capacitance Tolerance	Rated Voltage	Rated Current (mA)	(6) DC Resistance	Insulation Resistance	Specifications and Test Methods (Operating / Storage Temp. Range)
1	NFA31GD1016R84D	100 pF	±20 %	DC 6 V	50mA(DC)	6.8±40%	1000MΩmin.	Section 7.1 (-40 to 85 °C / -40 to 85 °C)
2	NFA31GD1014704D	100 pF	±20 %	DC 6 V	20mA(DC)	47±30%	1000MΩmin.	Section 7.1 (-40 to 85 °C / -40 to 85 °C)
3	NFA31GD1011014D	100 pF	±20 %	DC 6 V	15mA(DC)	100±30%	1000MΩmin.	Section 7.1 (-40 to 85 °C / -40 to 85 °C)
4	NFA31GD1006R84D	10 pF	±20 %	DC 6 V	50mA(DC)	6.8±40%	1000MΩmin.	Section 7.1 (-40 to 85 °C / -40 to 85 °C)
5	NFA31GD1004704D	10 pF	±20 %	DC 6 V	20mA(DC)	47±30%	1000MΩmin.	Section 7.1 (-40 to 85 °C / -40 to 85 °C)
6	NFA31GD1001014D	10 pF	±20 %	DC 6 V	15mA(DC)	100±30%	1000MΩmin.	Section 7.1 (-40 to 85 °C / -40 to 85 °C)
7	NFA31GD4706R84D	47 pF	±20 %	DC 6 V	50mA(DC)	6.8±40%	1000MΩmin.	Section 7.1 (-40 to 85 °C / -40 to 85 °C)
8	NFA31GD4703304D	47 pF	±20 %	DC 6 V	20mA(DC)	33±30%	1000MΩmin.	Section 7.1 (-40 to 85 °C / -40 to 85 °C)
9	NFA31GD4704704D	47 pF	±20 %	DC 6 V	20mA(DC)	47±30%	1000MΩmin.	Section 7.1 (-40 to 85 °C / -40 to 85 °C)
10	NFA31GD4701014D	47 pF	±20 %	DC 6 V	15mA(DC)	100±30%	1000MΩmin.	Section 7.1 (-40 to 85 °C / -40 to 85 °C)

6. Package

	MURATA PART NO.	(6) Packaging	Packaging Unit
1	NFA31GD1016R84D	φ180mm Reel PAPER	4000 pcs./Reel
2	NFA31GD1014704D	φ180mm Reel PAPER	4000 pcs./Reel
3	NFA31GD1011014D	φ180mm Reel PAPER	4000 pcs./Reel
4	NFA31GD1006R84D	φ180mm Reel PAPER	4000 pcs./Reel
5	NFA31GD1004704D	φ180mm Reel PAPER	4000 pcs./Reel
6	NFA31GD1001014D	φ180mm Reel PAPER	4000 pcs./Reel
7	NFA31GD4706R84D	φ180mm Reel PAPER	4000 pcs./Reel
8	NFA31GD4703304D	φ180mm Reel PAPER	4000 pcs./Reel
9	NFA31GD4704704D	φ180mm Reel PAPER	4000 pcs./Reel
10	NFA31GD4701014D	φ180mm Reel PAPER	4000 pcs./Reel

Product specifications in this catalog are as of Dec.15,2014,and are subject to change or obsolescence without notice.
Please consult the approval sheet before ordering.
Please read rating and !Cautions first.

■ SPECIFICATIONS AND TEST METHODS

Electrical Performance

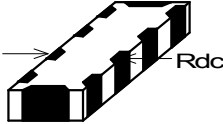
No	Item	Specification	Test Method
1	Capacitance (Cap.)	Meet item 5.	Frequency : 1.0 ± 0.1 MHz Voltage : 1 ± 0.2 V(rms)
2	Insulation Resistance(I.R.)		Voltage : Rated Voltage Time : 2 minutes max.
3	Withstanding Voltage	Products shall not be damaged.	Test Voltage : 50 V(DC) Time : 1 to 5 s Charge Current : 50 mA max.
4	DC Resistance (Line to Line)	Meet item 5.	4 terminal method. Measured with 1mA max. 
5	Operating Temperature	Shown in item 5.	Includes self-heating
6	Storage Temperature		

Standard Testing Condition

< Unless otherwise specified >

Temperature : Ordinary Temp. / 15 °C to 35 °C

Humidity: Ordinary Humidity / 25 %(RH) to 85 %(RH)

< In case of doubt >

Temperature: 20 °C \pm 2 °C

Humidity: 60 %(RH) to 70 %(RH)

Atmospheric pressure: 86 kPa to 106 kPa

■ SPECIFICATIONS AND TEST METHODS

Mechanical Performance

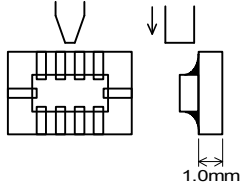
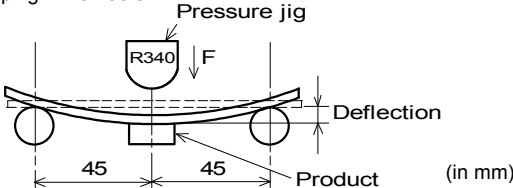
No	Item	Specification	Test Method										
1	Appearance and Dimensions	Meet item 4.	Visual Inspection and measured with Slide Calipers.										
2	Bonding Strength	The electrodes shall be no failure after tested.	It shall be soldered on the glass-epoxy substrate. Applying Force (F) : 9.8 N Applying Time : 30 s 										
3	Solderability	Electrodes shall be at least 90% covered with new solder coating.	Flux : Ethanol solution of rosin, 25(wt)% Pre-heat : 150±10°C, 60 to 90s Solder : Sn-3.0Ag-0.5Cu Solder Temperature : 240 ± 3°C Immersion Time : 3±1 s Immersion and emersion rates : 25mm / s										
4	Resistance to soldering heat	Meet Table 1. <table border="1" data-bbox="448 860 855 972"> <thead> <tr> <th colspan="2">Table 1</th> </tr> </thead> <tbody> <tr> <td>Appearance</td> <td>No damaged</td> </tr> <tr> <td>Cap. Change</td> <td>Within ±7.5%</td> </tr> <tr> <td>I.R.</td> <td>Meet the initial rated value.</td> </tr> <tr> <td>Rdc Change</td> <td>Within ± 10%</td> </tr> </tbody> </table>	Table 1		Appearance	No damaged	Cap. Change	Within ±7.5%	I.R.	Meet the initial rated value.	Rdc Change	Within ± 10%	Flux : Ethanol solution of rosin, 25(wt)% Pre-heat : 150±10°C, 60 to 90s Solder : Sn-3.0Ag-0.5Cu Solder Temperature : 270 ± 5°C Immersion Time : 10 ± 1 s Immersion and emersion rates : 25mm / s Initial values : measured after heat treatment(150+0/-10°C, 1hour) and exposure in the room condition for following hours. NFA31GD100***** : 24±2 hours The others : 48±4 hours Then measured after exposure in the room condition for the above hours.
Table 1													
Appearance	No damaged												
Cap. Change	Within ±7.5%												
I.R.	Meet the initial rated value.												
Rdc Change	Within ± 10%												
5	Bending Strength	Meet Table 2. <table border="1" data-bbox="448 1207 855 1279"> <thead> <tr> <th colspan="2">Table 2</th> </tr> </thead> <tbody> <tr> <td>Appearance</td> <td>No damaged</td> </tr> <tr> <td>Cap. Change</td> <td>Within ±12.5%</td> </tr> <tr> <td>Rdc Change</td> <td>Within ±10%</td> </tr> </tbody> </table>	Table 2		Appearance	No damaged	Cap. Change	Within ±12.5%	Rdc Change	Within ±10%	It shall be soldered on the glass-epoxy substrate(t = 1.0mm). Deflection : 2 mm Keeping Time : 30 s 		
Table 2													
Appearance	No damaged												
Cap. Change	Within ±12.5%												
Rdc Change	Within ±10%												
6	Drop	Products shall be no failure after tested.	It shall be dropped on concrete or steel board. Method : Free fall Height : 75 cm Attitude from which the product is dropped : 3 directions The Number of Time : 3 times for each direction (Total 9 times)										
7	Vibration	Meet Table 3. <table border="1" data-bbox="448 1653 855 1749"> <thead> <tr> <th colspan="2">Table 3</th> </tr> </thead> <tbody> <tr> <td>Appearance</td> <td>No damaged</td> </tr> <tr> <td>Capacitance</td> <td>Meet the initial rated value.</td> </tr> <tr> <td>Rdc Change</td> <td>Within ± 10%</td> </tr> </tbody> </table>	Table 3		Appearance	No damaged	Capacitance	Meet the initial rated value.	Rdc Change	Within ± 10%	It shall be soldered on the glass-epoxy substrate. Oscillation Frequency : 10 to 55 to 10Hz for 1 minute. Double Amplitude : 1.5 mm Time : A period of 2 hours in each of 3 mutually perpendicular directions. (Total 6 hours) Initial values: measured after heat treatment(150+0/-10 °C, 1hour) and exposure in the room condition for following hours. NFA31GD100***** : 24±2 hours The others : 48±4 hours Then measured after exposure in the room condition for the above hours.		
Table 3													
Appearance	No damaged												
Capacitance	Meet the initial rated value.												
Rdc Change	Within ± 10%												

■ SPECIFICATIONS AND TEST METHODS

Environment Performance

It shall be soldered on the glass-epoxy substrate.

No	Item	Specification	Test Method								
1	Temperature Cycling	Meet Table 4. Table 4 <table border="1" style="width: 100%;"> <tr> <td>Appearance</td> <td>No damaged</td> </tr> <tr> <td>Cap. Change</td> <td>Within ±20%</td> </tr> <tr> <td>I.R.</td> <td>Meet the initial rated value.</td> </tr> <tr> <td>Rdc Change</td> <td>Within ±20%</td> </tr> </table>	Appearance	No damaged	Cap. Change	Within ±20%	I.R.	Meet the initial rated value.	Rdc Change	Within ±20%	1 Cycle 1 step : -40+0/-3°C / 30+3/-0 min 2 step : Room Temperature / within 3 min 3 step : +85+3/-0°C / 30+3/-0 min 4 step : Room Temperature / within 3 min Total of 10 cycles Initial values : measured after heat treatment(150+0/-10°C, 1hour) and exposure in the room condition for following hours. NFA31GD100***** : 24±2 hours The others : 48±4 hours Then measured after exposure in the room condition for the above hours.
Appearance	No damaged										
Cap. Change	Within ±20%										
I.R.	Meet the initial rated value.										
Rdc Change	Within ±20%										
2	Cold Resistance		Temperature : -40±2°C Time : 1000+48/-0 hours Then measured after exposure in the room condition for following hours. NFA31GD100***** : 24±2 hours The others : 48±4 hours								
3	Humidity	Meet Table 5. Table 5 <table border="1" style="width: 100%;"> <tr> <td>Appearance</td> <td>No damaged</td> </tr> <tr> <td>Cap. Change</td> <td>Within ±12.5%</td> </tr> <tr> <td>I.R.</td> <td>Meet the initial rated value.</td> </tr> <tr> <td>Rdc Change</td> <td>Within ±20%</td> </tr> </table>	Appearance	No damaged	Cap. Change	Within ±12.5%	I.R.	Meet the initial rated value.	Rdc Change	Within ±20%	Temperature : 40±2°C Humidity : 90 to 95%(RH) Time : 1000+48/-0 hours Then measured after exposure in the room condition for following hours. NFA31GD100***** : 24±2 hours The others : 48±4 hours
Appearance	No damaged										
Cap. Change	Within ±12.5%										
I.R.	Meet the initial rated value.										
Rdc Change	Within ±20%										
4	Heat Life		Temperature : 85±2°C Test Voltage : Rated Voltage x 200% Time : 1000+48/-0 hours Initial values : measured after voltage treatment (Maximum Operating Temperature ±2°C, Rated Voltage x 200%, 1hour) and exposure in the room condition for following hours. Voltage rating -between terminal (3)(4)(5)(6) or (7)(8)(9)(10) and (1)(2). (ref. item 4) NFA31GD100***** : 24±2 hours The others : 48±4 hours Then measured after exposure in the room condition for the above hours.								

8.

1. Appearance and Dimensions (8mm-wide paper tape)

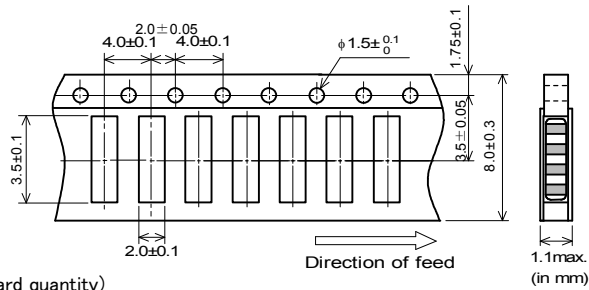

2. Specification of Taping

- (1) Packing quantity (standard quantity)
4000 pcs. / reel
- (2) Packing Method
Products shall be packaged in the cavity of the base tape and sealed by top tape and bottom tape.
- (3) Sprocket Hole
The sprocket holes are to the right as the tape is pulled toward the user.
- (4) Spliced point
The base tape and top tape have no spliced point.
- (5) Missing components number
Missing components number within 0.1% of the number per reel or 1 pc., whichever is greater, and are not continuous. The specified quantity per reel is kept.

3. Pull Strength of Top Tape and Bottom Tape

5N min.

4. Peeling off force of top tape

0.1N to 0.6N (minimum value is typical)
Speed of Peeling off : 300 mm / min

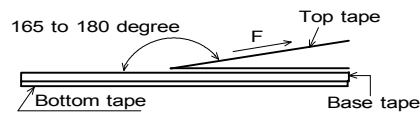

5. Dimensions of Leader-tape, Trailer and Reel

There shall be leader-tape (top tape and empty tape) and trailer-tape (empty tape) as follows.

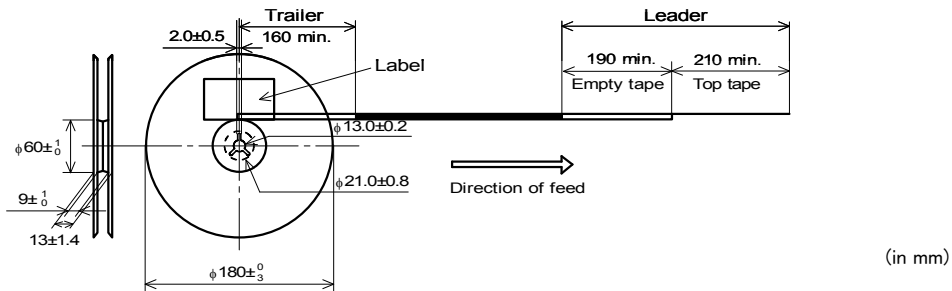

(in mm)

1. Mounting density

Add special attention to radiating heat of products when mounting this product near the products with heating.

The excessive heat by other products may cause deterioration of insulation resistance and excessive heat at this product, resulting in a fire.

2. Limitation of Applications

Please contact us before using our products for the applications listed below which require especially high reliability for the prevention of defects which might directly cause damage to the third party's life, body or property.

- (1)Aircraft equipment (2)Aerospace equipment (3)Undersea equipment (4)Power plant control equipment
- (5)Medical equipment (6)Transportation equipment(automobiles, trains, ships, etc.) (7)Traffic signal equipment
- (8)Disaster prevention / crime prevention equipment (9)Data-processing equipment
- (10)Applications of similar complexity or with reliability requirements comparable to the applications listed in the above

This product is designed for solder mounting.
Please consult us in advance for applying other mounting method such as conductive adhesive.

1. Flux and Solder

Flux	Use rosin-based flux, Do not use highly acidic flux (with chlorine content exceeding 0.2(wt)%). Do not use water-soluble flux. Other flux (except above) Please contact us for details, then use.
Solder	Use Sn-3.0Ag-0.5Cu solder

2. Note for Assembling

< Thermal Shock >

Pre-heating should be in such a way that the temperature difference between solder and products surface is limited to 100°C max. Also cooling into solvent after soldering should be in such a way that the temperature difference is limited to 100°C max.

<Exclusive Use of Reflow Soldering>

Products can only be soldered with reflow.

If it were soldered with flow,cracks might be caused in the ceramic body.

3. Attention Regarding P.C.B. Bending

The following shall be considered when designing P.C.B.'s and laying out products.

(1) P.C.B. shall be designed so that products are not subject to the mechanical stress for board warpage.

[Products direction]

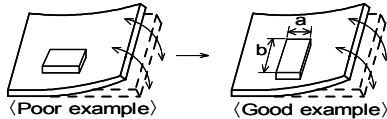

Products shall be located in the sideways direction (Length:a<b) to the mechanical stress.

(2) Products location on P.C.B. near seam for separation.

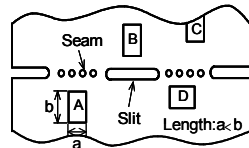

Products (A,B,C,D) shall be located carefully so that products are not subject to the mechanical stress due to warping the board. Because they may be subjected the mechanical stress in order of A>C>B≐D.

4. Pre-heating Temperature

Soldering shall be handled so that the difference between pre-heating temperature and solder temperature shall be limited to 100°C max. to avoid the heat stress for the products.

5. Reflow Soldering

1) Soldering paste printing for reflow

- Standard thickness of solder paste: 100µm to 200µm.
- Use the solder paste printing pattern of the right pattern.
- For the resist and copper foil pattern, use standard land dimensions.

• Standard printing pattern of solder paste.

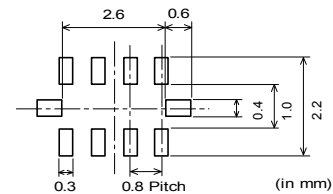

2) Soldering Conditions

Standard soldering profile and the limit soldering profile is as follows.

The excessive limit soldering conditions may cause leaching of the electrode and/or resulting in the deterioration of product quality.

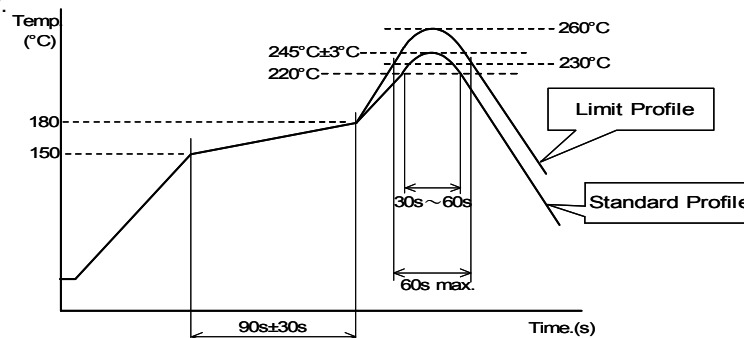

	Standard Profile	Limit Profile
Pre-heating	150°C ~ 180°C , 90s ± 30s	
Heating	above 220°C , 30s ~ 60s	above 230°C , 60s max.
Peak temperature	245°C ± 3°C	260°C , 10s
Cycle of reflow	2 times	2 times

6. Reworking with Soldering iron

The following conditions shall be strictly followed when using a soldering iron.

- Pre-heating : 150°C, 1 min
- Tip temperature : 350°C max.
- Soldering time : 3(+1,-0) s

Note: Do not directly touch the products with the tip of the soldering iron in order to prevent the crack on the ceramic material due to the thermal shock.

13.7. Solder Volume

Solder shall be used not to be exceeded as shown below.

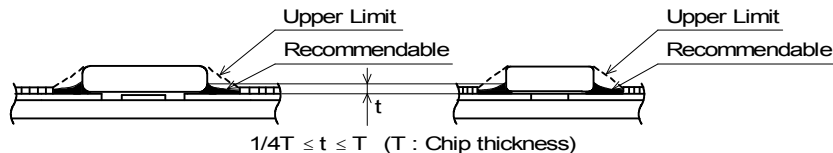

Accordingly increasing the solder volume, the mechanical stress to product is also increased. Excessive solder volume may cause the failure of mechanical or electrical performance.

13.8. Cleaning Conditions

Products shall be cleaned on the following conditions.

- (1) Cleaning temperature shall be limited to 60°C max. (40°C max. for Isopropyl alcohol (IPA))
- (2) Ultrasonic cleaning shall comply with the following conditions, with avoiding the resonance phenomenon at the mounted products and P.C.B.

Power : 20W / l max.
 Frequency : 28kHz to 40kHz
 Time : 5 minutes max.

(3) Cleaner

1. Cleaner
Isopropyl alcohol (IPA)
2. Aqueous agent
PINE ALPHA ST-100S

- (4) There shall be no residual flux and residual cleaner after cleaning.

In the case of using aqueous agent, products shall be dried completely after rinse with de-ionized water in order to remove the cleaner.

- (5) Other cleaning
Please contact us.

13.9. Operating Environment

Do not use this product under the following environmental conditions, on deterioration of the performance, such as insulation resistance may result from the use.

- (1) in the corrodible atmosphere (acidic gases, alkaline gases, chlorine, sulfur gases, organic gases and etc.)
- (2) in the atmosphere where liquid such as organic solvent, may splash on the products.

13.10. Resin coating

The capacitance value may change and/or it may affect on the product's performance due to high cure-stress of resin to be used for coating / molding products. So please pay your careful attention when you select resin. In prior to use, please make the reliability evaluation with the product mounted in your application set.

13.11. Handling of a substrate

After mounting products on a substrate, do not apply any stress to the product caused by bending or twisting to the substrate when cropping the substrate, inserting and removing a connector from the substrate or tightening screw to the substrate. Excessive mechanical stress may cause cracking in the product.

Bending

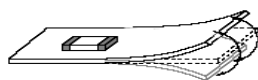

Twisting

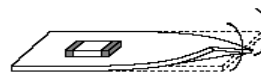

11. Standard Land Dimensions

The chip EMI filter suppresses noise by conducting the high-frequency noise element to ground. Therefore, to get enough noise reduction, feed through holes which is connected to ground-plane should be arranged according to the figure to reinforce the ground-pattern.

< Standard land dimensions for reflow >

•Side on which chips are mounted

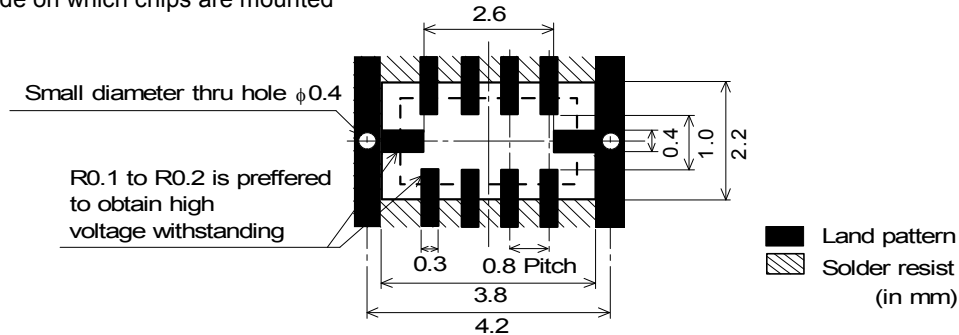

13.12. Storage condition

(1) Storage period

Use the products within 12 months after delivered.

Solderability should be checked if this period is exceeded.

(2) Storage environment condition

• Products should be stored in the warehouse on the following conditions.

Temperature: -10 to $+40^{\circ}\text{C}$

Humidity: 15 to 85% relative humidity

No rapid change on temperature and humidity

• Don't keep products in corrosive gases such as sulfur, chlorine gas or acid, or it may cause oxidization of electrode, resulting in poor solderability.

• Products should be stored on the palette for the prevention of the influence from humidity, dust and so on.

• Products should be stored in the warehouse without heat shock, vibration, direct sunlight and so on.

• Products should be stored under the airtight packaged condition.

(3) Delivery

Care should be taken when transporting or handling product to avoid excessive vibration or mechanical shock.

- (1) Please make sure that your product has been evaluated in view of your specifications with our product being mounted to your product.
- (2) You are requested not to use our product deviating from the agreed specifications.
- (3) We consider it not appropriate to include any terms and conditions with regard to the business transaction in the product specifications, drawings or other technical documents. Therefore, if your technical documents as above include such terms and conditions such as warranty clause, product liability clause, or intellectual property infringement liability clause, they will be deemed to be invalid.

X-ON Electronics

Largest Supplier of Electrical and Electronic Components

Click to view similar products for [EMI Filter Circuits](#) category:

Click to view products by [Murata](#) manufacturer:

Other Similar products are found below :

[761280-1](#) [SBSGC0500224MXB](#) [SBSPP0250104MXT](#) [SBSPP0250154MXT](#) [SBSPP0500473MXT](#) [SBSPP1000102MXT](#)
[SBSPP1000153MXB](#) [SBSPP1000220MCT](#) [SBSPP1000332MXT](#) [SBSPP1000470MCT](#) [SBSPP1000471MCT](#) [SBSPP1000472MXT](#)
[SNZF220DFT1G](#) [CM1442-06CP](#) [EMI8041MUTAG](#) [SBSPP0500473MXB](#) [SBSPP1000101MCT](#) [SBSPP1000103MXT](#) [SBSPP1000220MCB](#)
[SBSPP1000221MCT](#) [EMIF06-USD05F3](#) [EMIF03-SIM03F3](#) [EMI7112FCTAG](#) [EMI7403FCTBG](#) [EMI2180MTTBG](#) [CM1442-08CP](#)
[CSPEMI204FCTAG](#) [SBSPP1000152MXT](#) [SBSGC5000473MXT](#) [SBSMC0500474MXT](#) [EMI8043MUTAG](#) [MEA2010PE360T001](#)
[NFA18SL307V1A45L](#) [1-6609037-5](#) [CM1690-06DE](#) [EMIF05-SK01F3](#) [EMIF02-USB03F2](#) [BNX022-01L](#) [BNX024H01L](#) [BNX025H01L](#)
[BNX026H01L](#) [NFA21SL806X1A48L](#) [NFL18SP157X1A3D](#) [NFL21SP106X1C3D](#) [NFL21SP207X1C3D](#) [NFL21SP307X1C3D](#)
[NFL21SP506X1C3D](#) [NFL21SP706X1C3D](#) [NFW31SP207X1E4L](#) [BNX022-01B](#)