

# NXFT15XV103FA2B090

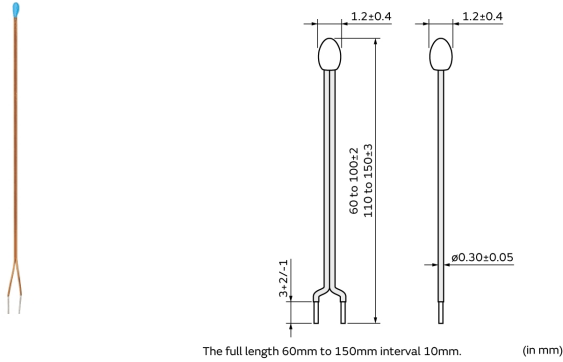

## Appearance & Shape



## Features

1. High accuracy and high sensibility temperature sensing is available by the small size and high accuracy NTC Thermistor.
2. Narrow space temperature sensing is available by the small sensing head and the thin lead wire.
3. You can choose the optimum length according to the design layout.
4. This product is compatible with our 0402 (EIA) size chip Thermistor.
5. Excellent long time aging stability
6. This is halogen free product (Cl= max.900ppm、Br=max.900ppm and Cl+Br=max.1500ppm).
7. Lead is not contained in the product.
8. UL/cULcertified product.(UL 1434, File No. E137188)

## Applications

Limited Usage	Consumer Grade
---------------	----------------

## Packaging Information

Packaging	Specifications	Standard Packing Quantity
B	Bulk(Bag)	1000

**Attention**  
 1.This datasheet is downloaded from the website of Murata Manufacturing Co., Ltd. Therefore, it's specifications are subject to change or our products in it may be discontinued without advance notice. Please check with our sales representatives or product engineers before ordering.  
 2.This datasheet has only typical specifications because there is no space for detailed specifications.  
 Therefore, please review our product specifications or consult the approval sheet for product specifications before ordering.

# NXFT15XV103FA2B090



## Specifications

Resistance (25°C)	10kΩ
Resistance Value Tolerance (at 25°C)	±1%
B-Constant (25/50°C)	3936K
B-Constant (25/50°C) Tolerance	±1%
B-Constant(25/80°C) (Reference Value)	3971K
B-Constant(25/85°C) (Reference Value)	3977K
B-Constant(25/100°C) (Reference Value)	3989K
Maximum Operating Current (25°C)	0.12mA
Rated Electric Power (25°C)	7.5mW
Typical Dissipation Constant (25°C)	1.5mW/°C
Operating Temperature Range	-40°C to 125°C
Thermal Time Constant	4s
Lead Shape	Lead Wire type
Size Code (in mm)	090 = 90mm
Size Code (in inch)	090 = 90mm
Shape	Lead
Mass	0.09g
MSL	N

### Attention

1.This datasheet is downloaded from the website of Murata Manufacturing Co., Ltd. Therefore, it's specifications are subject to change or our products in it may be discontinued without advance notice. Please check with our sales representatives or product engineers before ordering.

2.This datasheet has only typical specifications because there is no space for detailed specifications.

Therefore, please review our product specifications or consult the approval sheet for product specifications before ordering.

# NXFT15XV103FA2B090

## Product Data

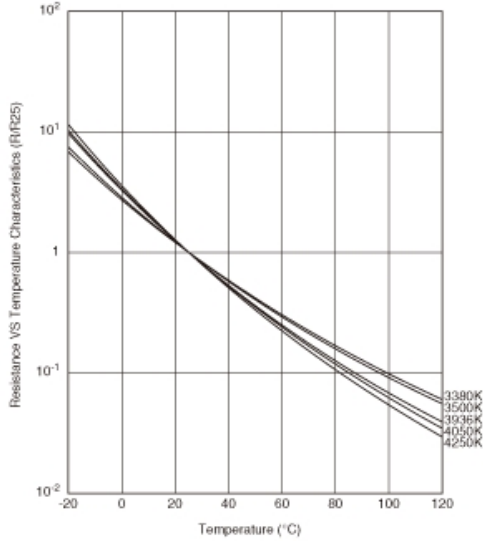

Resistance-Temperature Characteristics

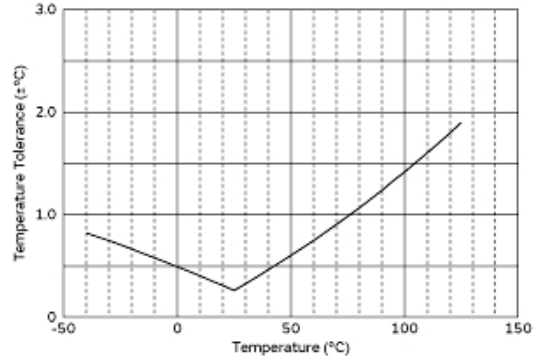

Temperature Tolerance VS. Temp.

**Attention**

- 1.This datasheet is downloaded from the website of Murata Manufacturing Co., Ltd. Therefore, it's specifications are subject to change or our products in it may be discontinued without advance notice. Please check with our sales representatives or product engineers before ordering.
- 2.This datasheet has only typical specifications because there is no space for detailed specifications.  
Therefore, please review our product specifications or consult the approval sheet for product specifications before ordering.

## X-ON Electronics

Largest Supplier of Electrical and Electronic Components

*Click to view similar products for [NTC \(Negative Temperature Coefficient\) Thermistors](#) category:*

*Click to view products by [Murata](#) manufacturer:*

Other Similar products are found below :

[118-253FAJ-P01](#) [121-202EAC-P01](#) [123-802EAJ-P01](#) [128-105NDP-Q02](#) [135-503LAD-J01](#) [B57250V2104F360](#) [B57250V2473F560](#)  
[B57620C472K962](#) [NTCLE410E3103F](#) [A1004SG22P0](#) [199-303KAF-A02](#) [30054-4](#) [M09N038F](#) [B57423V2473H062](#) [B57471V2474H062](#)  
[B57620C5223J062](#) [500-52AA04-101](#) [526-31AA19-104](#) [526-31AN12-202](#) [103AT-5-1P-FT](#) [10K3A542I](#) [112-103FAG-H02](#) [112-104KAG-](#)  
[B01](#) [11028414-00](#) [111-182CAG-H01](#) [112-103FAF-H01](#) [112-104KBF-F01](#) [118-202CAJ-P01](#) [526-31AA79-102](#) [B57442V5103J62](#)  
[B57401V2103H62](#) [B57621C5472J62](#) [11032565-00](#) [194303KEVA01](#) [NTCACAPE3C90193](#) [USP11595](#) [B57359V2224J260](#)  
[B57343V5103J360](#) [50070974-003-01](#) [189-602LDR-A01](#) [B57621C5472K062](#) [135-105QAF-J02](#) [B57421V2153J062](#) [B57230V2103H260](#)  
[B57471V2684H062](#) [B57471V2333H062](#) [126-153YJC-B01](#) [NTCS0603E3333FHT](#) [118-802EAJ-P01](#) [121-103FAC-Q02](#)