

## FEATURES

- Small package: SMD/TH: 30.85 x 20.0 x 8.2 mm (1.215 x 0.787 x 0.323 in); SIP: 33.0 x 7.6 x 18.1 mm (1.30 x 0.30 x 0.713 in)
- 0.6 V - 3.3 V output voltage range
- High efficiency, typ. 97.2% at 5Vin, 3.3Vout half load
- Configuration and monitoring via PMBus™
- Adaptive compensation of PWM control loop & fast loop transient response
- Synchronization & phase spreading
- Current sharing, voltage tracking & voltage margining
- Voltage setting via pin-strap or PMBus™
- MTBF 14.2 Mh
- Non-Linear Response for reduction of decoupling capacitor
- Remote control & power good
- Output short-circuit, output over voltage, & over temperature protection
- Certified to UL/IEC 60950-1

## PRODUCT OVERVIEW

The OKDx-T/50-W12 series are high efficiency, digital point-of-Load (PoL) DC-DC power converters capable of delivering 50A/165W. Available in three different package formats, through-hole, single-in-line, and surface mount, these converters have a typical efficiency of 97.2%. PMBus™ compatibility allows monitoring and configuration of critical system-level performance require-

ments. Apart from standard PoL performance and safety features like OVP, OCP, OTP, and UVLO, these digital converters have advanced features: digital current sharing (full power, no derating), non-linear transient response, optimized dead time control, synchronization, and phase spreading. These converters are ideal for use in telecommunications, networking, and distributed power applications.

## Power Management via PMBus™

- Configurable soft-start/stop
- Configurable output voltage (Vout) and voltage margins (Margin low and Margin high)
- Configurable protection limits for OVP, input over voltage, input under voltage, over current, on/off, and temperature
- Status monitor Vout, Iout, Vin, Temp, Power good, and On/Off

## Applications

- Distributed power architectures
- Intermediate bus voltage applications
- Servers and storage applications
- Network equipment

## PART NUMBER STRUCTURE

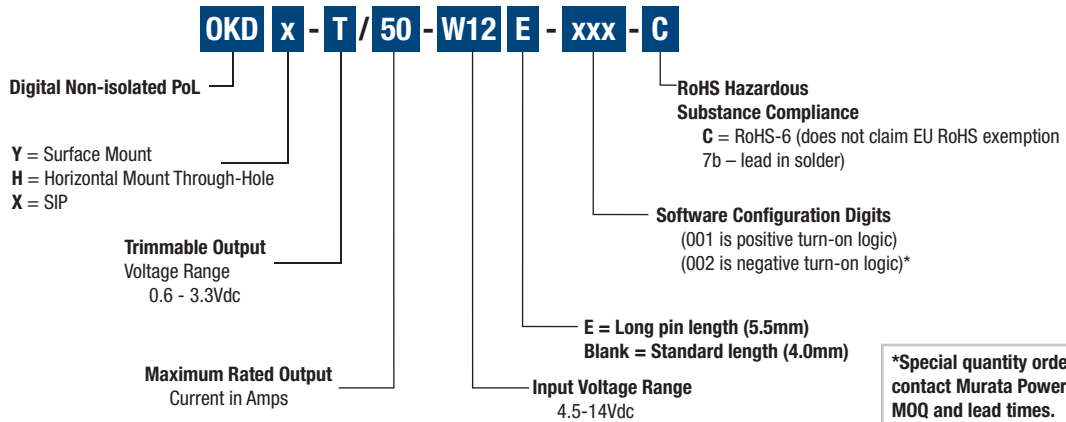

ORDERING GUIDE	
Model Number	Output
OKDY-T/50-W12-001-C	0.6-3.3 V, 50 A/ 165 W
OKDH-T/50-W12-001-C	
OKDX-T/50-W12-001-C	
OKDX-T/50-W12E-001-C	
OKDH-T/50-W12-002-C	
OKDX-T/50-W12-002-C	

**Absolute Maximum Ratings**

Characteristics		Min	Typ	Max	Unit
T <sub>P2</sub>	Operating temperature (see Thermal Consideration section)	-40		125	°C
T <sub>S</sub>	Storage temperature	-40		125	°C
V <sub>I</sub>	Input voltage (See Operating Information Section for input and output voltage relations)	-0.3		16	V
Logic I/O voltage	CTRL, SA0, SA1, SALERT, SCL, SDA, VSET, SYNC, GCB, PG	-0.3		6.5	V
Ground voltage differential	-S, PREF, GND	-0.3		0.3	V
Analog pin voltage	VO, +S, VTRK	-0.3		6.5	V

General and Safety	Conditions	Min	Typ	Max	Unit
Safety	Designed for UL/IEC/EN 60950 1				
Calculated MTBF	Telcordia SR-332, Issue 2 Method 1		14.2		Mhrs

Stress in excess of Absolute Maximum Ratings may cause permanent damage. Absolute Maximum Ratings, sometimes referred to as no destruction limits, are normally tested with one parameter at a time exceeding the limits in the Electrical Specification. If exposed to stress above these limits, function and performance may degrade in an unspecified manner.

**Configuration File**

This product is designed with a digital control circuit. The control circuit uses a configuration file which determines the functionality and performance of the product. The Electrical Specification table shows parameter values of functionality and performance with the

default configuration file, unless otherwise specified. The default configuration file is designed to fit most application needs with focus on high efficiency. If different characteristics are required it is possible to change the configuration file to optimize certain performance characteristics. Note that current sharing operation requires changed configuration file.

In this Technical specification examples are included to show the possibilities with digital control. See Operating Information section for information about trade offs when optimizing certain key performance characteristics.

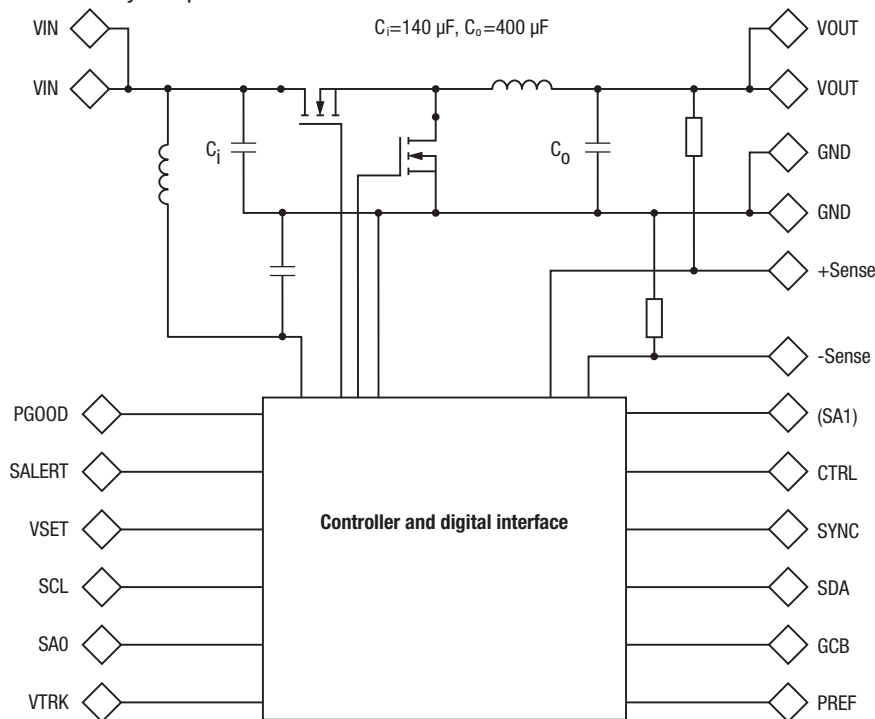

Fundamental Circuit Diagram

## Electrical Specifications, OKDY-T/50-W12-C and OKDH-T/50-W12-C

$T_{P1} = -30$  to  $+95^{\circ}\text{C}$ ,  $V_{IN} = 4.5$  to  $14\text{ V}$ ,  $V_{IN} > V_{OUT} + 1.0\text{ V}$

Typical values given at:  $T_{P1} = +25^{\circ}\text{C}$ ,  $V_{IN} = 12.0\text{ V}$ , max IOU, unless otherwise specified under Conditions.

Default configuration file, 190 10-CDA 102 0206/001.

External CIN =  $470\text{ }\mu\text{F}/10\text{ m}\Omega$ , COU =  $470\text{ }\mu\text{F}/10\text{ m}\Omega$ . See Operating Information section for selection of capacitor types.

Sense pins are connected to the output pins.

Characteristics		Conditions	Min	Typ	Max	Unit
$V_i$	Input voltage rise time	monotonic			2.4	V/ms
$V_o$	Output voltage without pin strap			1.2		V
	Output voltage adjustment range		0.60		3.3	V
	Output voltage adjustment including margining	See Note 17	0.54		3.63	V
	Output voltage set-point resolution			$\pm 0.025$		% FS
	Output voltage accuracy	Including line, load, temp. See Note 14 Current sharing operation See Note 15	-1		1	%
			-2		2	%
	Internal resistance +S/-S to VOUT/GND			47		$\Omega$
	Line regulation	$V_o = 0.6\text{ V}$		2		mV
		$V_o = 1.0\text{ V}$		2		
		$V_o = 1.8\text{ V}$		2		
$V_o = 3.3\text{ V}$			3			
Load regulation; $I_o = 0 - 100\%$	$V_o = 0.6\text{ V}$		2		mV	
	$V_o = 1.0\text{ V}$		2			
	$V_o = 1.8\text{ V}$		2			
	$V_o = 3.3\text{ V}$		2			
$V_{Oac}$	Output ripple & noise $C_o = 470\text{ }\mu\text{F}$ (minimum external capacitance). See Note 11	$V_o = 0.6\text{ V}$		20	mVp-p	
		$V_o = 1.0\text{ V}$		25		
		$V_o = 1.8\text{ V}$		30		
		$V_o = 3.3\text{ V}$		35		
$I_o$	Output current	See Note 18	0.001		50	A
$I_s$	Static input current at max $I_o$	$V_o = 0.6\text{ V}$		3.10	A	
		$V_o = 1.0\text{ V}$		4.80		
		$V_o = 1.8\text{ V}$		8.19		
		$V_o = 3.3\text{ V}$		14.53		
$I_{lim}$	Current limit threshold		52		65	A
$I_{sc}$	Short circuit current	RMS, hiccup mode, See Note 3	$V_o = 0.6\text{ V}$		11	A
			$V_o = 1.0\text{ V}$		9	
			$V_o = 1.8\text{ V}$		7	
			$V_o = 3.3\text{ V}$		6	
$\eta$	Efficiency	50% of max $I_o$	$V_o = 0.6\text{ V}$		85.6	%
			$V_o = 1.0\text{ V}$		90.4	
			$V_o = 1.8\text{ V}$		93.7	
			$V_o = 3.3\text{ V}$		95.7	
		max $I_o$	$V_o = 0.6\text{ V}$		80.5	%
			$V_o = 1.0\text{ V}$		86.9	
			$V_o = 1.8\text{ V}$		91.6	
			$V_o = 3.3\text{ V}$		94.6	
$P_d$	Power dissipation at max $I_o$	$V_o = 0.6\text{ V}$		7.25	W	
		$V_o = 1.0\text{ V}$		7.54		
		$V_o = 1.8\text{ V}$		8.28		
		$V_o = 3.3\text{ V}$		9.36		
$P_{ii}$	Input idling power (no load)	Default configuration: Continuous Conduction Mode, CCM	$V_o = 0.6\text{ V}$		0.90	W
			$V_o = 1.0\text{ V}$		0.90	
			$V_o = 1.8\text{ V}$		1.10	
			$V_o = 3.3\text{ V}$		1.67	

Characteristics		Conditions	Min	Typ	Max	Unit
$P_{CTRL}$	Input standby power	Turned off with CTRL-pin Default configuration: Monitoring enabled, Precise timing enabled		170		mW
$C_i$	Internal input capacitance			140		$\mu$ F
$C_o$	Internal output capacitance			400		$\mu$ F
$C_{OUT}$	Total external output capacitance	See Note 9	470		30 000	$\mu$ F
	ESR range of capacitors (per single capacitor)	See Note 9	5		30	m $\Omega$

$V_{tr1}$	Load transient peak voltage deviation (L to H/H to L) Load step 25-75-25% of max $I_o$	Default configuration di/dt = 2 A/ $\mu$ s $C_o$ = 470 $\mu$ F (minimum external capacitance) see Note 12	$V_o$ = 0.6 V		79 / 256	mV
			$V_o$ = 1.0 V		127 / 298	
			$V_o$ = 1.8 V		144 / 324	
			$V_o$ = 3.3 V		210 / 327	
$t_{tr1}$	Load transient recovery time, Note 5 (L to H/H to L) Load step 25-75-25% of max $I_o$	Default configuration di/dt = 2 A/ $\mu$ s $C_o$ = 470 $\mu$ F (minimum external capacitance) see Note 12	$V_o$ = 0.6 V		60 / 100	$\mu$ s
			$V_o$ = 1.0 V		100 / 100	
			$V_o$ = 1.8 V		100 / 100	
			$V_o$ = 3.3 V		100 / 100	

$f_s$	Switching frequency			320		kHz
	Switching frequency range	PMBus configurable		200-640		kHz
	Switching frequency set-point accuracy		-5		5	%
	Control Circuit PWM Duty Cycle		5		95	%
	Minimum Sync Pulse Width		150			ns
	Input Clock Frequency Drift Tolerance	External clock source	-13		13	%

Input Under Voltage Lockout, UVLO	UVLO threshold			3.85		V
	UVLO threshold range	PMBus configurable		3.85-14		V
	Set point accuracy		-150		150	mV
	UVLO hysteresis			0.35		V
	UVLO hysteresis range	PMBus configurable		0-10.15		V
	Delay			2.5		$\mu$ s
	Fault response	See Note 3		Automatic restart, 70 ms		
Input Over Voltage Protection, IOVP	IOVP threshold			16		V
	IOVP threshold range	PMBus configurable		4.2-16		V
	Set point accuracy		-150		150	mV
	IOVP hysteresis			1		V
	IOVP hysteresis range	PMBus configurable		0-11.8		V
	Delay			2.5		$\mu$ s
	Fault response	See Note 3		Automatic restart, 70 ms		
Power Good, PG, See Note 2	PG threshold			90		% $V_o$
	PG hysteresis			5		% $V_o$
	PG delay	See Note 19		Direct after DLC		
	PG delay range	PMBus configurable		0-500		s
Output voltage Over/Under Voltage Protection, OVP/UVP	UVP threshold			85		% $V_o$
	UVP threshold range	PMBus configurable		0-100		% $V_o$
	UVP hysteresis			5		% $V_o$
	OVP threshold			115		% $V_o$
	OVP threshold range	PMBus configurable		100-115		% $V_o$
	UVP/OVP response time			25		$\mu$ s
	UVP/OVP response time range	PMBus configurable		5-60		$\mu$ s
Fault response	See Note 3		Automatic restart, 70 ms			
Over Current Protection, OCP	OCP threshold			62		A
	OCP threshold range	PMBus configurable		0-62		A
	Protection delay,	See Note 4		32		$T_{sw}$
	Protection delay range	PMBus configurable		1-32		$T_{sw}$
	Fault response	See Note 3		Automatic restart, 70 ms		

Characteristics	Conditions	Min	Typ	Max	Unit
Over Temperature Protection, OTP at P2 See Note 8	OTP threshold		120		°C
	OTP threshold range	PMBus configurable	-40...+125		°C
	OTP hysteresis		25		°C
	OTP hysteresis range	PMBus configurable	0-165		°C
	Fault response	See Note 3	Automatic restart, 240 ms		

$V_{IL}$	Logic input low threshold	SYNC, SA0, SA1, SCL, SDA, GCB, CTRL, VSET			0.8	V
$V_{IH}$	Logic input high threshold		2			V
$I_{IL}$	Logic input low sink current	CTRL			0.6	mA
$V_{OL}$	Logic output low signal level	SYNC, SCL, SDA, SALERT, GCB, PG			0.4	V
$V_{OH}$	Logic output high signal level		2.25			V
$I_{OL}$	Logic output low sink current				4	mA
$I_{OH}$	Logic output high source current				2	mA
$t_{set}$	Setup time, SMBus		See Note 1	300		
$t_{hold}$	Hold time, SMBus	See Note 1	250			ns
$t_{free}$	Bus free time, SMBus	See Note 1	2			ms
$C_p$	Internal capacitance on logic pins			10		pF

Initialization time		See Note 10		40		ms
Output Voltage Delay Time See Note 6	Delay duration	See Note 16		10		ms
	Delay duration range	PMBus configurable		5-500000		
	Delay accuracy turn-on			-0.25/+4		ms
	Delay accuracy turn-off			-0.25/+4		ms
Output Voltage Ramp Time See Note 13	Ramp duration			10		ms
	Ramp duration range	PMBus configurable		0-200		
	Ramp time accuracy			100		μs
		Current sharing operation		20		%

VTRK Input Bias Current	$V_{VTRK} = 5.5 V$		110	200		μA
VTRK Tracking Ramp Accuracy ( $V_0 - V_{VTRK}$ )	100% tracking, see Note 7		-100	100		mV
	Current sharing operation 2 phases, 100% tracking $V_0 = 1.0 V$ , 10 ms ramp			±100		mV
VTRK Regulation Accuracy ( $V_0 - V_{VTRK}$ )	100% Tracking		-1	1		%
	Current sharing operation 100% Tracking		-2	2		%

Current difference between products in a current sharing group	Steady state operation	Max 2 x READ_IOUT monitoring accuracy			
	Ramp-up		4		A
Number of products in a current sharing group				7	

Monitoring accuracy	READ_VIN vs $V_I$			3		%
	READ_VOUT vs $V_0$			1		%
	READ_IOUT vs $I_0$	$I_0 = 0-50 A, T_{P1} = 0 \text{ to } +95 \text{ °C}$ $V_I = 4.5-14 V, V_0 = 1.0 V$		±3.0		A
	READ_IOUT vs $I_0$	$I_0 = 0-50 A, T_{P1} = 0 \text{ to } +95 \text{ °C}$ $V_I = 4.5-14 V, V_0 = 0.6-3.3 V$		±5.0		A

Note 1: See section I<sup>2</sup>C/SMBus Setup and Hold Times – Definitions.

Note 2: Monitorable over PMBus Interface.

Note 3: Automatic restart ~70 or 240 ms after fault if the fault is no longer present. Continuous restart attempts if the fault reappear after restart. See Operating Information for other fault response options.

Note 4: Tsw is the switching period.

Note 5: Within +/-3% of V0

Note 6: See section Soft-start Power Up.

Note 7: Tracking functionality is designed to follow a VTRK signal with slew rate < 2.4 V/ms. For faster VTRK signals accuracy will depend on the regulator bandwidth.

Note 8: See section Over Temperature Protection (OTP).

Note 9: See section External Capacitors.

Note 10: See section Initialization Procedure.

Note 11: See graph Output Ripple vs External Capacitance and Operating information section Output Ripple and Noise.

Note 12: See graph Load Transient vs. External Capacitance and Operating information section External Capacitors.

Note 13: Time for reaching 100% of nominal Vout.

Note 14: For Vout < 1.0 V accuracy is +/-10 mV. For further deviations see section Output Voltage Adjust using PMBus.

Note 15: Accuracy here means deviation from ideal output voltage level given by configured droop and actual load.

Includes line, load and temperature variations.

Note 16: For current sharing the Output Voltage Delay Time must be reconfigured to minimum 15 ms.

Note 17: For steady state operation above 1.05 x 3.3 V, please contact your local Murata sales representative.

Note 18: A minimum load current is not required if Low Power mode is used (monitoring disabled).

Note 19: See sections Dynamic Loop Compensation and Power Good.

**Typical Characteristics**  
**Efficiency and Power Dissipation**

**Efficiency vs. Output Current,  $V_I = 5\text{ V}$**

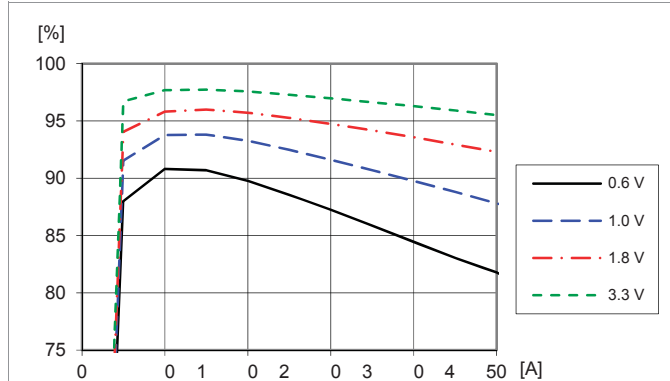

Efficiency vs. load current and output voltage:  
 $T_{P1} = +25\text{ }^\circ\text{C}$ ,  $V_I = 5\text{ V}$ ,  $f_{sw} = 320\text{ kHz}$ ,  $C_O = 470\text{ }\mu\text{F}/10\text{ m}\Omega$ .

**Power Dissipation vs. Output Current,  $V_I = 5\text{ V}$**

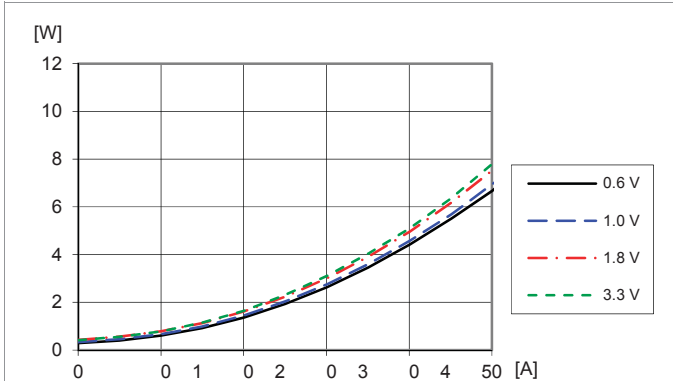

Dissipated power vs. load current and output voltage:  
 $T_{P1} = +25\text{ }^\circ\text{C}$ ,  $V_I = 5\text{ V}$ ,  $f_{sw} = 320\text{ kHz}$ ,  $C_O = 470\text{ }\mu\text{F}/10\text{ m}\Omega$ .

**Efficiency vs. Output Current,  $V_I = 12\text{ V}$**

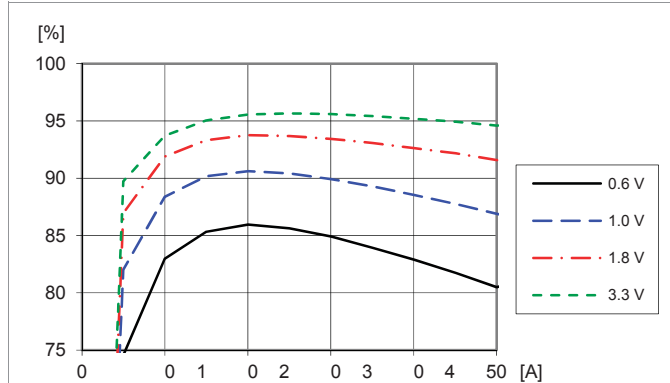

Efficiency vs. load current and output voltage at  
 $T_{P1} = +25\text{ }^\circ\text{C}$ ,  $V_I = 12\text{ V}$ ,  $f_{sw} = 320\text{ kHz}$ ,  $C_O = 470\text{ }\mu\text{F}/10\text{ m}\Omega$ .

**Power Dissipation vs. Output Current,  $V_I = 12\text{ V}$**

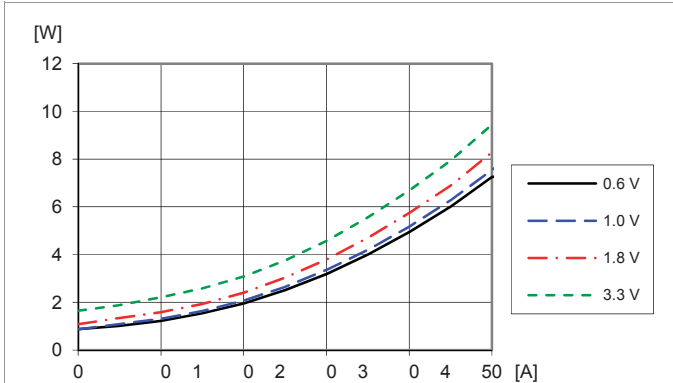

Dissipated power vs. load current and output voltage:  
 $T_{P1} = +25\text{ }^\circ\text{C}$ ,  $V_I = 12\text{ V}$ ,  $f_{sw} = 320\text{ kHz}$ ,  $C_O = 470\text{ }\mu\text{F}/10\text{ m}\Omega$ .

**Efficiency vs. Output Current and Switching Frequency**

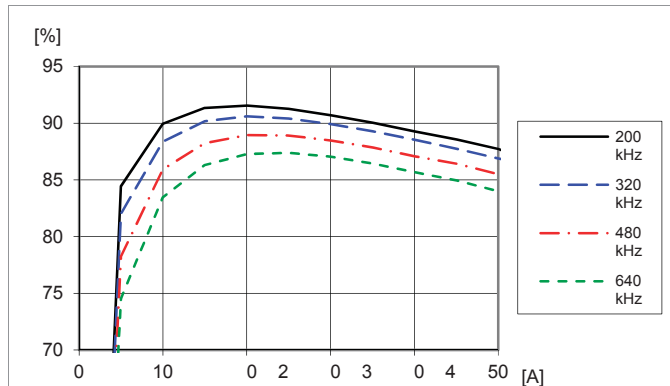

Efficiency vs. load current and switch frequency at  
 $T_{P1} = +25\text{ }^\circ\text{C}$ ,  $V_I = 12\text{ V}$ ,  $V_O = 1.0\text{ V}$ ,  $C_O = 470\text{ }\mu\text{F}/10\text{ m}\Omega$ .  
Default configuration except changed frequency

**Power Dissipation vs. Output Current and Switching frequency**

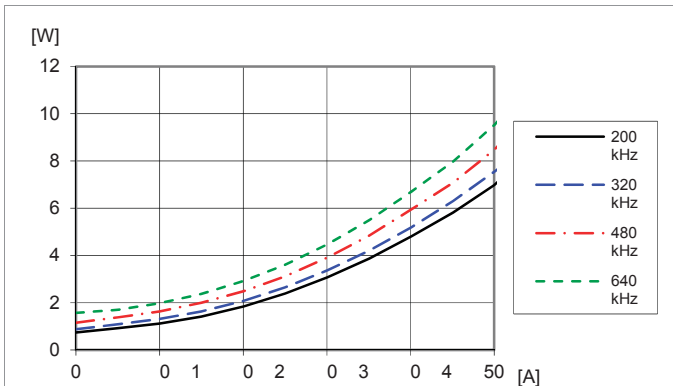

Dissipated power vs. load current and switch frequency at  
 $T_{P1} = +25\text{ }^\circ\text{C}$ ,  $V_I = 12\text{ V}$ ,  $V_O = 1.0\text{ V}$ ,  $C_O = 470\text{ }\mu\text{F}/10\text{ m}\Omega$ .  
Default configuration except changed frequency

**Typical Characteristics**  
**Load Transient**

**Load Transient vs. External Capacitance,  $V_O = 1.0\text{ V}$**

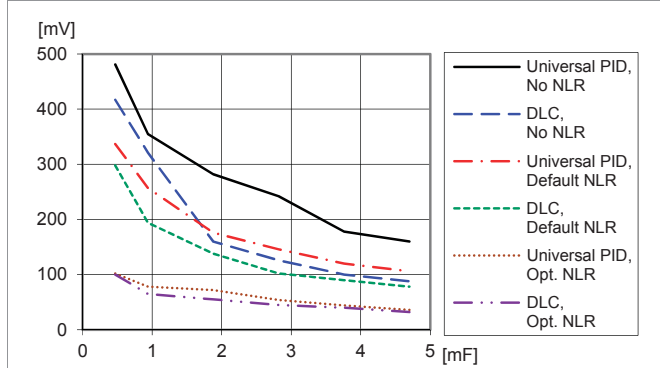

Load transient peak voltage deviation vs. external capacitance.  
Step (12.5-37.5-12.5 A). Parallel coupling of capacitors with 470  $\mu\text{F}/10\text{ m}\Omega$ ,  
 $T_{P1} = +25\text{ }^\circ\text{C}$ ,  $V_I = 12\text{ V}$ ,  $V_O = 1.0\text{ V}$ ,  $f_{sw} = 320\text{ kHz}$ ,  $di/dt = 2\text{ A}/\mu\text{s}$

**Load Transient vs. External Capacitance,  $V_O = 3.3\text{ V}$**

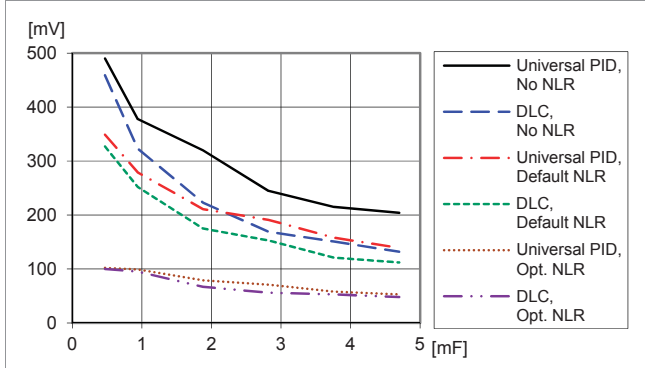

Load transient peak voltage deviation vs. external capacitance.  
Step (12.5-37.5-12.5 A). Parallel coupling of capacitors with 470  $\mu\text{F}/10\text{ m}\Omega$ ,  
 $T_{P1} = +25\text{ }^\circ\text{C}$ ,  $V_I = 12\text{ V}$ ,  $V_O = 3.3\text{ V}$ ,  $f_{sw} = 320\text{ kHz}$ ,  $di/dt = 2\text{ A}/\mu\text{s}$

**Load transient vs. Switch Frequency**

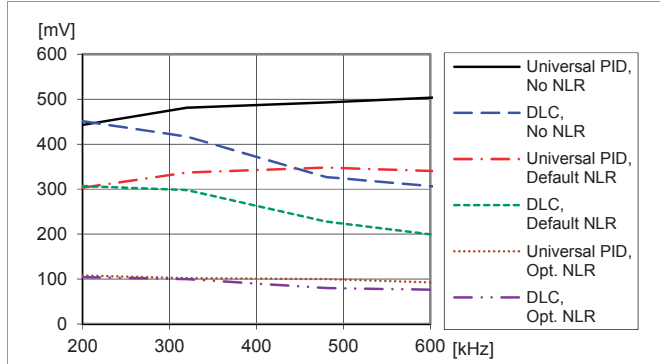

Load transient peak voltage deviation vs. frequency.  
Step-change (12.5-37.5-12.5 A).  
 $T_{P1} = +25\text{ }^\circ\text{C}$ ,  $V_I = 12\text{ V}$ ,  $V_O = 1.0\text{ V}$ ,  $C_O = 470\text{ }\mu\text{F}/10\text{ m}\Omega$

**Output Load Transient Response, Default Configuration**

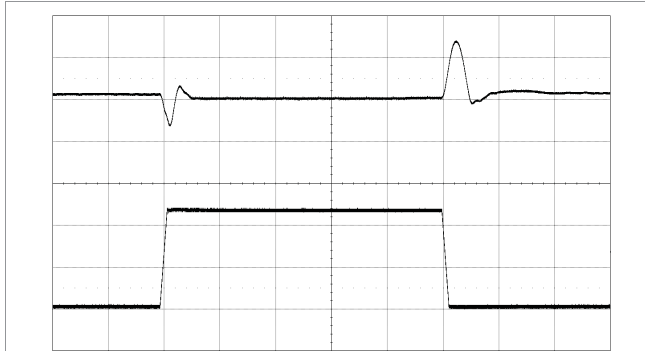

Output voltage response to load current  
Step-change (12.5-37.5-12.5 A) at:  
 $T_{P1} = +25\text{ }^\circ\text{C}$ ,  $V_I = 12\text{ V}$ ,  $V_O = 1.0\text{ V}$   
 $di/dt = 2\text{ A}/\mu\text{s}$ ,  $f_{sw} = 320\text{ kHz}$   
 $C_O = 470\text{ }\mu\text{F}/10\text{ m}\Omega$   
Top trace: output voltage (200 mV/div.).  
Bottom trace: load current (10 A/div.).  
Time scale: (0.1 ms/div.).

Note 1: For Universal PID, see section Dynamic Loop Compensation (DLC).  
Note 2: In the load transient graphs, the worst-case scenario (load step 37.5-12.5 A) has been considered.

**Typical Characteristics**  
**Output Current Characteristic**

**Output Current Derating,  $V_O = 0.6\text{ V}$**

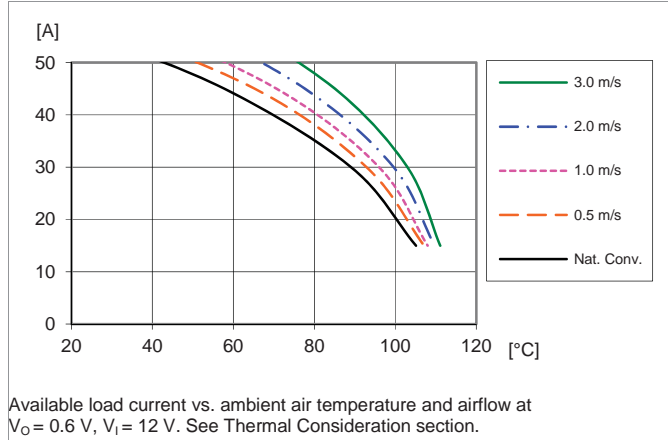

**Output Current Derating,  $V_O = 1.0\text{ V}$**

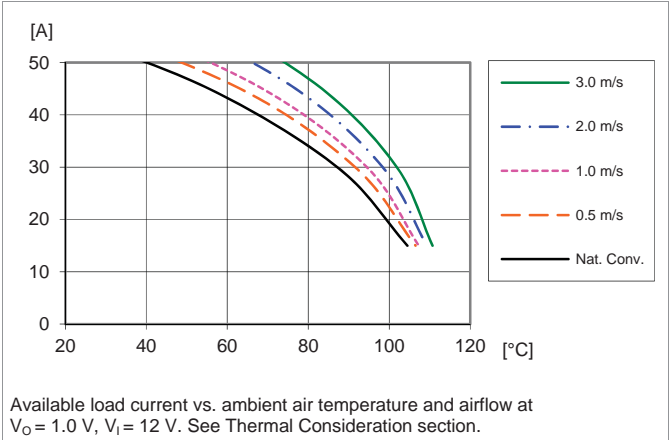

**Output Current Derating,  $V_O = 1.8\text{ V}$**

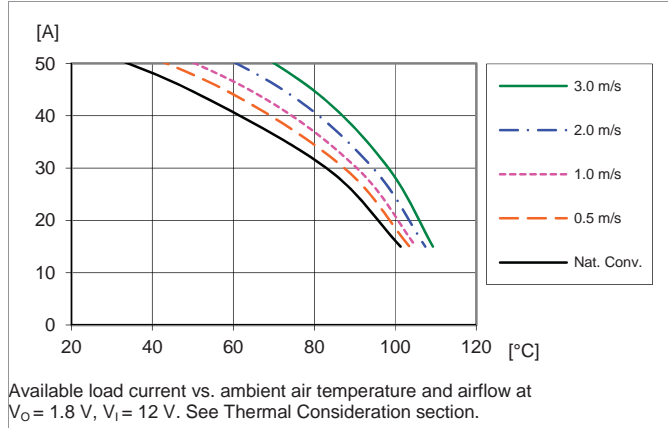

**Output Current Derating,  $V_O = 3.3\text{ V}$**

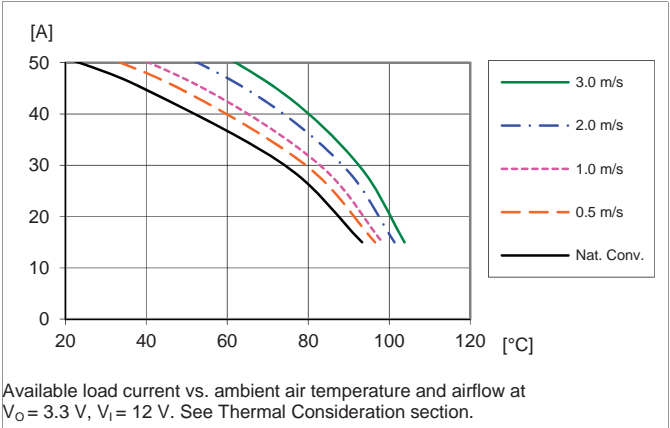

**Current Limit Characteristics,  $V_O = 1.0\text{ V}$**

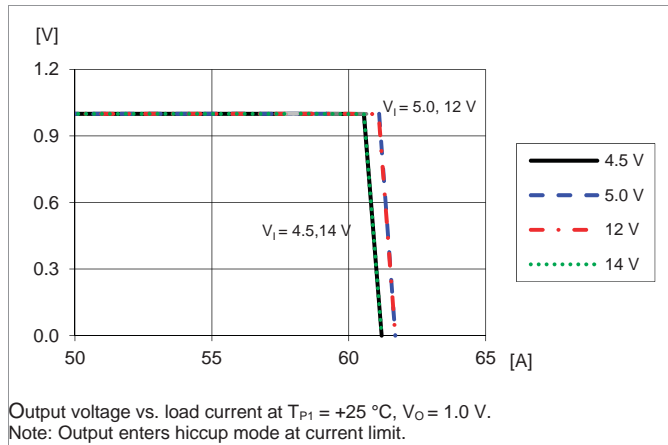

**Current Limit Characteristics,  $V_O = 3.3\text{ V}$**

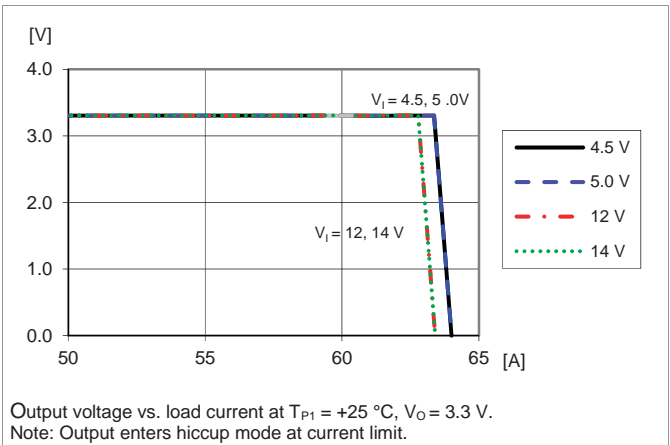



**Typical Characteristics**  
**Output Voltage**

**Output Ripple & Noise,  $V_O = 1.0\text{ V}$**

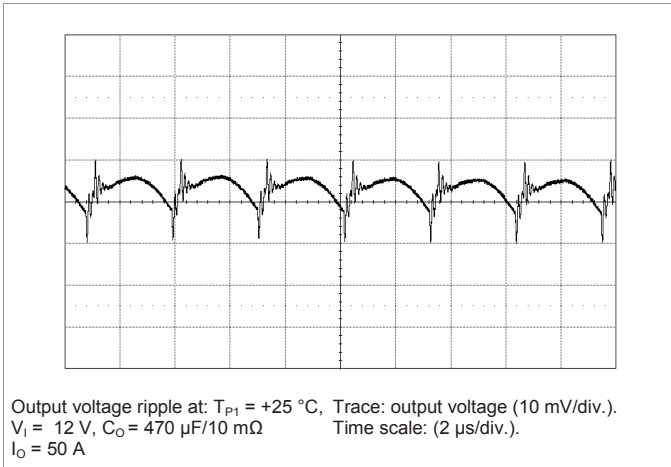

**Output Ripple & Noise,  $V_O = 3.3\text{ V}$**

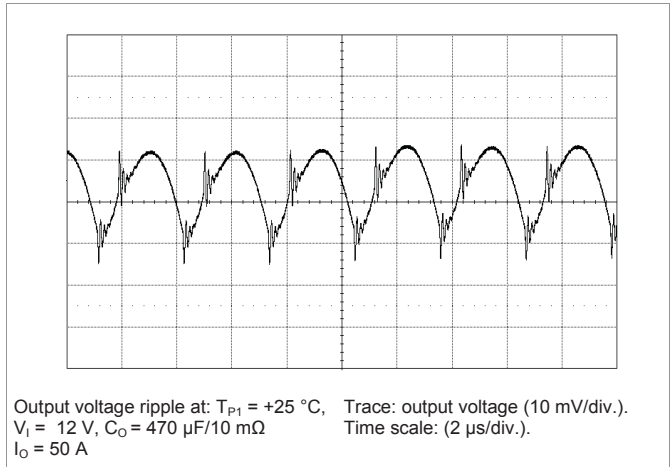

**Output Ripple vs. Input Voltage**

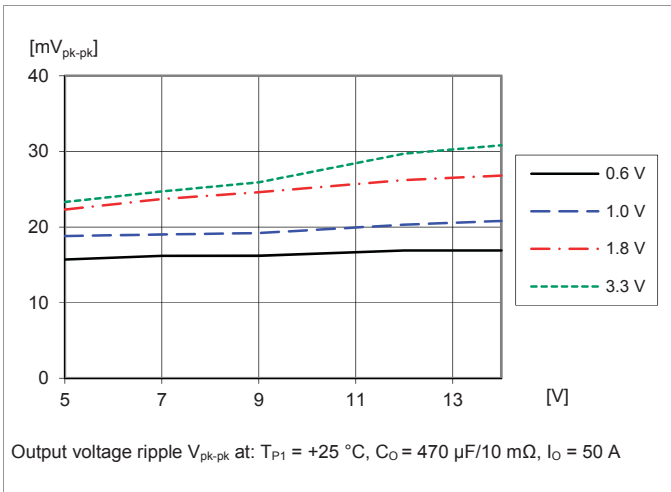

**Output Ripple vs. Frequency**

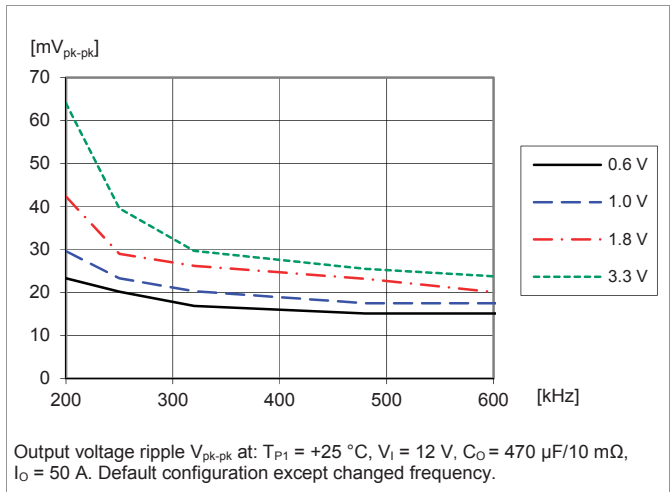

**Output Ripple vs. External Capacitance**

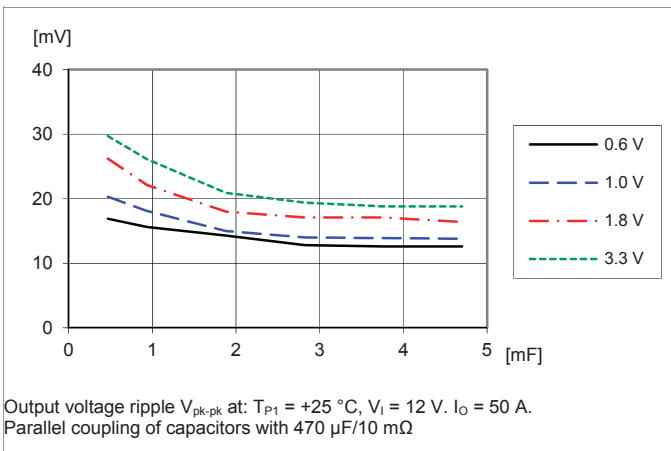

**Load regulation,  $V_O = 1.0\text{ V}$**

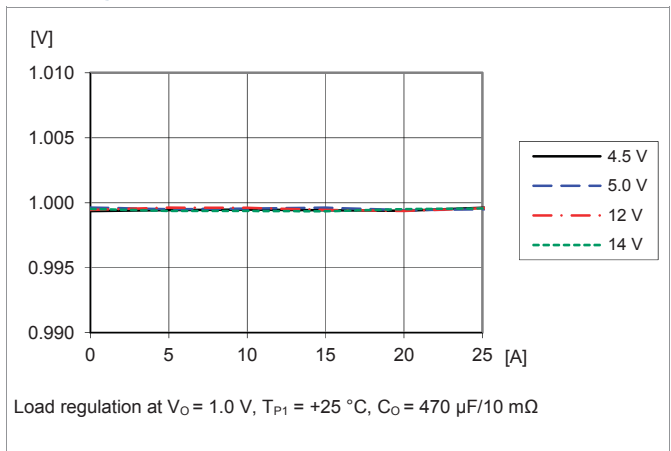

**Typical Characteristics**  
**Start-up and shut-down**

**Start-up by input source**

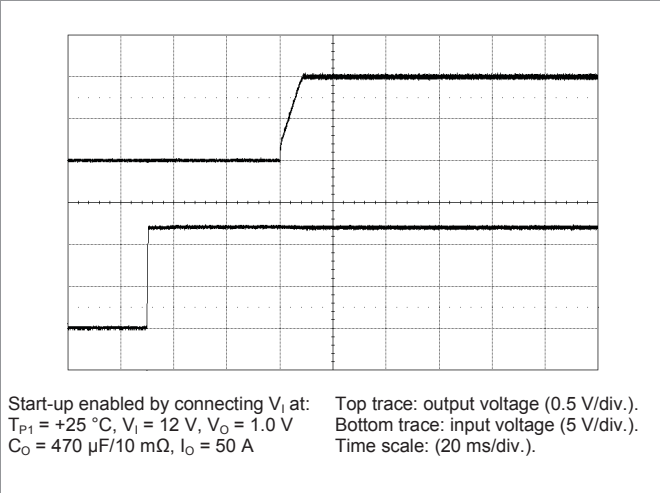

**Shut-down by input source**

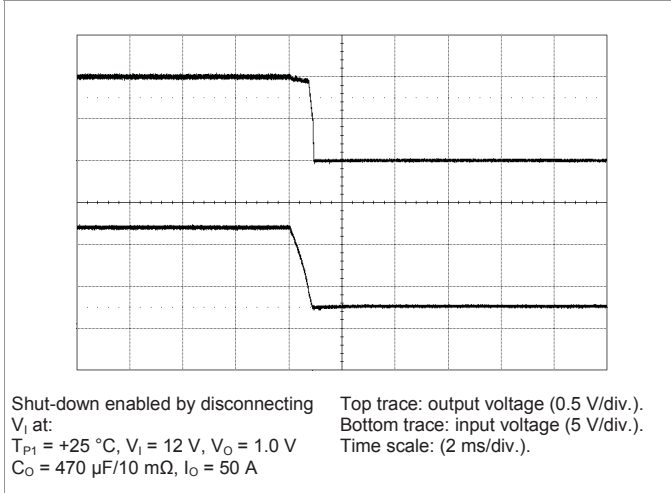

**Start-up by CTRL signal**

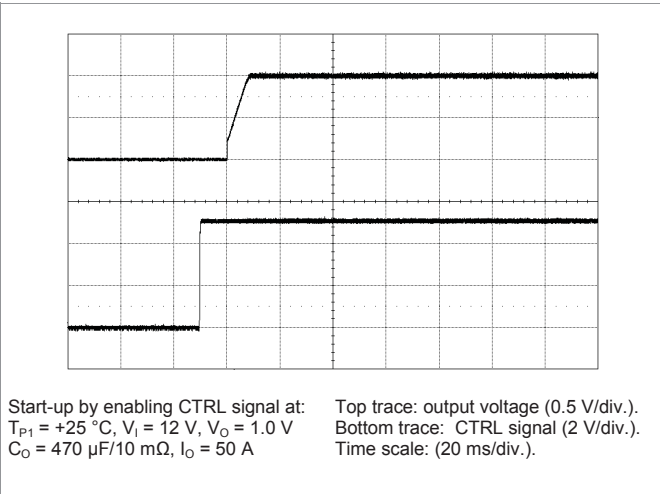

**Shut-down by CTRL signal**

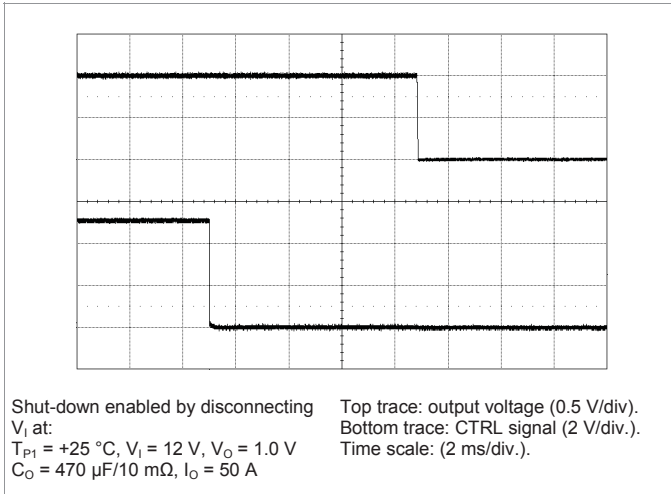

### Electrical Specifications, OKDX-T/50-W12-C

$T_{P1} = -30$  to  $+95$  °C,  $V_i = 4.5$  to  $14$  V,  $V_i > V_o + 1.0$  V

Typical values given at:  $T_{P1} = +25$  °C,  $V_i = 12.0$  V, max  $I_o$ , unless otherwise specified under Conditions.

Default configuration file, 190 10-CDA 102 0259/001.

External  $C_{IN} = 470$   $\mu$ F/10 m $\Omega$ ,  $C_{OUT} = 470$   $\mu$ F/10 m $\Omega$ . See Operating Information section for selection of capacitor types.

Sense pins are connected to the output pins.

Characteristics		Conditions	Min	Typ	Max	Unit	
$V_i$	Input voltage rise time	monotonic			2.4	V/ms	
$V_o$	Output voltage without pin strap			1.2		V	
	Output voltage adjustment range		0.60		3.3	V	
	Output voltage adjustment including margining	See Note 17	0.54		3.63	V	
	Output voltage set-point resolution			$\pm 0.025$		% FS	
	Output voltage accuracy	Including line, load, temp. See Note 14 Current sharing operation See Note 15	-1		1	%	
			-2		2	%	
	Internal resistance +S/-S to VOUT/GND			47		$\Omega$	
	Line regulation		$V_o = 0.6$ V		2	mV	
			$V_o = 1.0$ V		2		
			$V_o = 1.8$ V		2		
$V_o = 3.3$ V				3			
Load regulation; $I_o = 0 - 100\%$		$V_o = 0.6$ V		2	mV		
		$V_o = 1.0$ V		2			
		$V_o = 1.8$ V		2			
		$V_o = 3.3$ V		2			
$V_{Oac}$	Output ripple & noise $C_o = 470$ $\mu$ F (minimum external capacitance). See Note 11			$V_o = 0.6$ V	20	mVp-p	
				$V_o = 1.0$ V	25		
				$V_o = 1.8$ V	30		
				$V_o = 3.3$ V	40		
$I_o$	Output current	See Note 18	0.001		50	A	
$I_s$	Static input current at max $I_o$			$V_o = 0.6$ V	3.12	A	
				$V_o = 1.0$ V	4.81		
				$V_o = 1.8$ V	8.22		
				$V_o = 3.3$ V	14.59		
$I_{lim}$	Current limit threshold		52		65	A	
$I_{sc}$	Short circuit current	RMS, hiccup mode, See Note 3		$V_o = 0.6$ V	10	A	
				$V_o = 1.0$ V	8		
				$V_o = 1.8$ V	6		
				$V_o = 3.3$ V	5		
$\eta$	Efficiency	50% of max $I_o$		$V_o = 0.6$ V	85.2	%	
				$V_o = 1.0$ V	90.2		
				$V_o = 1.8$ V	93.3		
				$V_o = 3.3$ V	95.3		
		max $I_o$			$V_o = 0.6$ V	80.2	%
					$V_o = 1.0$ V	86.6	
					$V_o = 1.8$ V	91.2	
					$V_o = 3.3$ V	94.2	
$P_d$	Power dissipation at max $I_o$			$V_o = 0.6$ V	7.40	W	
				$V_o = 1.0$ V	7.73		
				$V_o = 1.8$ V	8.68		
				$V_o = 3.3$ V	10.15		
$P_{II}$	Input idling power (no load)	Default configuration: Continuous Conduction Mode, CCM		$V_o = 0.6$ V	0.95	W	
				$V_o = 1.0$ V	0.95		
				$V_o = 1.8$ V	1.22		
				$V_o = 3.3$ V	1.88		
$P_{CTRL}$	Input standby power	Turned off with CTRL-pin			170	mW	
$C_i$	Internal input capacitance			140		$\mu$ F	

Characteristics		Conditions	Min	Typ	Max	Unit
C <sub>o</sub>	Internal output capacitance			400		μF
	Total external output capacitance	See Note 9	470		30 000	μF
C <sub>OUT</sub>	ESR range of capacitors	See Note 9	5		30	mΩ
	(per single capacitor)					

V <sub>tr1</sub>	Load transient peak voltage deviation (L to H/H to L) Load step 25-75-25% of max I <sub>o</sub>	Default configuration di/dt = 2 A/μs C <sub>o</sub> = 470 μF (minimum external capacitance) see Note 12	V <sub>o</sub> = 0.6 V		90 / 300	mV
			V <sub>o</sub> = 1.0 V		120 / 300	
			V <sub>o</sub> = 1.8 V		160 / 305	
			V <sub>o</sub> = 3.3 V		230 / 315	
t <sub>tr1</sub>	Load transient recovery time, Note 5 (L to H/H to L) Load step 25-75-25% of max I <sub>o</sub>	Default configuration di/dt = 2 A/μs C <sub>o</sub> = 470 μF (minimum external capacitance) see Note 12	V <sub>o</sub> = 0.6 V		70 / 100	μs
			V <sub>o</sub> = 1.0 V		100 / 100	
			V <sub>o</sub> = 1.8 V		100 / 100	
			V <sub>o</sub> = 3.3 V		100 / 100	

f <sub>s</sub>	Switching frequency			320		kHz
	Switching frequency range	PMBus configurable		200-640		kHz
	Switching frequency set-point accuracy		-5		5	%
	Control Circuit PWM Duty Cycle		5		95	%
	Minimum Sync Pulse Width		150			ns
	Input Clock Frequency Drift Tolerance	External clock source	-13		13	%

Input Under Voltage Lockout, UVLO	UVLO threshold			3.85		V
	UVLO threshold range	PMBus configurable		3.85-14		V
	Set point accuracy		-150		150	mV
	UVLO hysteresis			0.35		V
	UVLO hysteresis range	PMBus configurable		0-10.15		V
	Delay			2.5		μs
Input Over Voltage Protection, IOVP	Fault response	See Note 3	Automatic restart, 70 ms			
	IOVP threshold			16		V
	IOVP threshold range	PMBus configurable		4.2-16		V
	Set point accuracy		-150		150	mV
	IOVP hysteresis			1		V
	IOVP hysteresis range	PMBus configurable		0-11.8		V
Power Good, PG, See Note 2	Delay			2.5		μs
	Fault response	See Note 3	Automatic restart, 70 ms			
	PG threshold			90		% V <sub>o</sub>
	PG hysteresis			5		% V <sub>o</sub>
	PG delay	See Note 19		Direct after DLC		ms
	PG delay range	PMBus configurable		0-500		s
Output voltage Over/Under Voltage Protection, OVP/UVP	UVP threshold			85		% V <sub>o</sub>
	UVP threshold range	PMBus configurable		0-100		% V <sub>o</sub>
	UVP hysteresis			5		% V <sub>o</sub>
	OVP threshold			115		% V <sub>o</sub>
	OVP threshold range	PMBus configurable		100-115		% V <sub>o</sub>
	UVP/OVP response time			25		μs
	UVP/OVP response time range	PMBus configurable		5-60		μs
Over Current Protection, OCP	Fault response	See Note 3	Automatic restart, 70 ms			
	OCP threshold			60		A
	OCP threshold range	PMBus configurable		0-60		A
	Protection delay,	See Note 4		32		T <sub>sw</sub>
	Protection delay range	PMBus configurable		1-32		T <sub>sw</sub>
	Fault response	See Note 3	Automatic restart, 70 ms			

Characteristics	Conditions	Min	Typ	Max	Unit
Over Temperature Protection, OTP at P2 See Note 8	OTP threshold		120		°C
	OTP threshold range	PMBus configurable	-40...+125		°C
	OTP hysteresis		25		°C
	OTP hysteresis range	PMBus configurable	0-165		°C
	Fault response	See Note 3	Automatic restart, 240 ms		

$V_{IL}$	Logic input low threshold	SYNC, SA0, SA1, SCL, SDA, GCB, CTRL, VSET			0.8	V
$V_{IH}$	Logic input high threshold		2			V
$I_L$	Logic input low sink current	CTRL			0.6	mA
$V_{OL}$	Logic output low signal level				0.4	V
$V_{OH}$	Logic output high signal level	SYNC, SCL, SDA, SALERT, GCB, PG	2.25			V
$I_{OL}$	Logic output low sink current				4	mA
$I_{OH}$	Logic output high source current				2	mA
$t_{set}$	Setup time, SMBus	See Note 1	300			ns
$t_{hold}$	Hold time, SMBus	See Note 1	250			ns
$t_{free}$	Bus free time, SMBus	See Note 1	2			ms
$C_p$	Internal capacitance on logic pins			10		pF

Initialization time		See Note 10		40		ms
Output Voltage Delay Time See Note 6	Delay duration	See Note 16		10		ms
	Delay duration range	PMBus configurable		5-500000		
	Delay accuracy turn-on			-0.25/+4		ms
	Delay accuracy turn-off			-0.25/+4		ms
Output Voltage Ramp Time See Note 13	Ramp duration			10		ms
	Ramp duration range	PMBus configurable		0-200		
	Ramp time accuracy			100		μs
		Current sharing operation		20		%

VTRK Input Bias Current	$V_{VTRK} = 5.5\text{ V}$			110	200	μA
VTRK Tracking Ramp Accuracy ( $V_0 - V_{VTRK}$ )	100% tracking, see Note 7		-100		100	mV
	Current sharing operation 2 phases, 100% tracking $V_0 = 1.0\text{ V}$ , 10 ms ramp			±100		mV
VTRK Regulation Accuracy ( $V_0 - V_{VTRK}$ )	100% Tracking		-1		1	%
	Current sharing operation 100% Tracking		-2		2	%

Current difference between products in a current sharing group	Steady state operation	Max 2 x READ_IOUT monitoring accuracy				
	Ramp-up			4		A
Number of products in a current sharing group					7	

Monitoring accuracy	READ_VIN vs $V_I$			3		%
	READ_VOUT vs $V_0$			1		%
	READ_IOUT vs $I_0$	$I_0 = 0-50\text{ A}$ , $T_{P1} = 0\text{ to }+95\text{ °C}$ $V_I = 4.5-14\text{ V}$ , $V_0 = 1.0\text{ V}$		±3.0		A
	READ_IOUT vs $I_0$	$I_0 = 0-50\text{ A}$ , $T_{P1} = 0\text{ to }+95\text{ °C}$ $V_I = 4.5-14\text{ V}$ , $V_0 = 0.6-3.3\text{ V}$		±5.0		A

Note 1: See section I<sup>2</sup>C/SMBus Setup and Hold Times – Definitions.  
 Note 2: Monitorable over PMBus Interface.  
 Note 3: Automatic restart ~70 or 240 ms after fault if the fault is no longer present. Continuous restart attempts if the fault reappear after restart. See Operating Information for other fault response options.  
 Note 4: Tsw is the switching period.  
 Note 5: Within +/-3% of V0  
 Note 6: See section Soft-start Power Up.  
 Note 7: Tracking functionality is designed to follow a VTRK signal with slew rate < 2.4 V/ms. For faster VTRK signals accuracy will depend on the regulator bandwidth.  
 Note 8: See section Over Temperature Protection (OTP).  
 Note 9: See section External Capacitors.  
 Note 10: See section Initialization Procedure.

Note 11: See graph Output Ripple vs External Capacitance and Operating information section Output Ripple and Noise.  
 Note 12: See graph Load Transient vs. External Capacitance and Operating information section External Capacitors.  
 Note 13: Time for reaching 100% of nominal Vout.  
 Note 14: For Vout < 1.0 V accuracy is +/-10 mV. For further deviations see section Output Voltage Adjust using PMBus.  
 Note 15: Accuracy here means deviation from ideal output voltage level given by configured droop and actual load. Includes line, load and temperature variations.  
 Note 16: For current sharing the Output Voltage Delay Time must be reconfigured to minimum 15 ms.  
 Note 17: For steady state operation above 1.05 x 3.3 V, please contact your local Murata sales representative.  
 Note 18: A minimum load current is not required if Low Power mode is used (monitoring disabled).  
 Note 19: See sections Dynamic Loop Compensation and Power Good.

**Typical Characteristics**  
**Efficiency and Power Dissipation**

**Efficiency vs. Output Current,  $V_I = 5\text{ V}$**

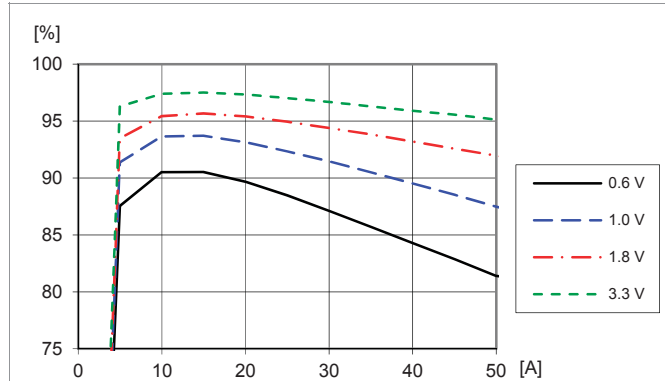

Efficiency vs. load current and output voltage:  
 $T_{P1} = +25\text{ }^\circ\text{C}$ ,  $V_I = 5\text{ V}$ ,  $f_{sw} = 320\text{ kHz}$ ,  $C_O = 470\text{ }\mu\text{F}/10\text{ m}\Omega$ .

**Power Dissipation vs. Output Current,  $V_I = 5\text{ V}$**

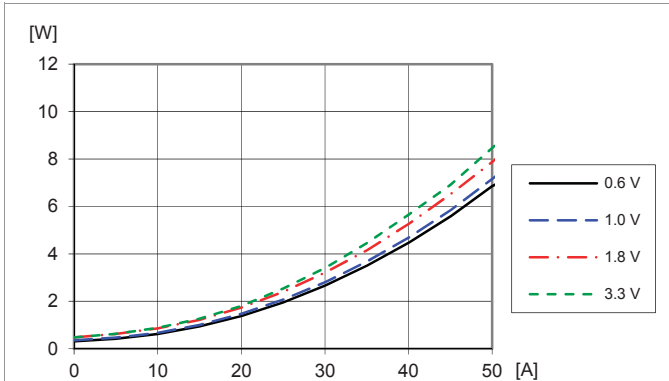

Dissipated power vs. load current and output voltage:  
 $T_{P1} = +25\text{ }^\circ\text{C}$ ,  $V_I = 5\text{ V}$ ,  $f_{sw} = 320\text{ kHz}$ ,  $C_O = 470\text{ }\mu\text{F}/10\text{ m}\Omega$ .

**Efficiency vs. Output Current,  $V_I = 12\text{ V}$**

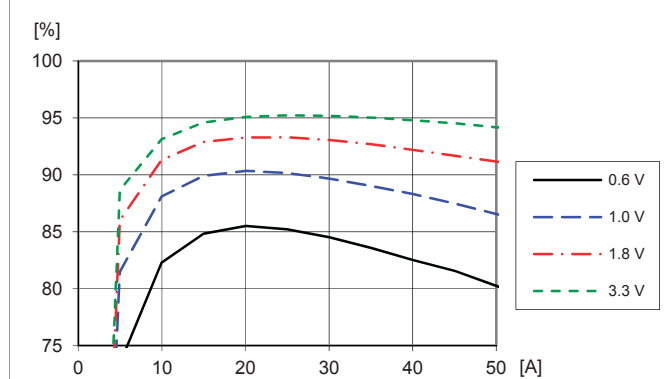

Efficiency vs. load current and output voltage at  
 $T_{P1} = +25\text{ }^\circ\text{C}$ ,  $V_I = 12\text{ V}$ ,  $f_{sw} = 320\text{ kHz}$ ,  $C_O = 470\text{ }\mu\text{F}/10\text{ m}\Omega$ .

**Power Dissipation vs. Output Current,  $V_I = 12\text{ V}$**

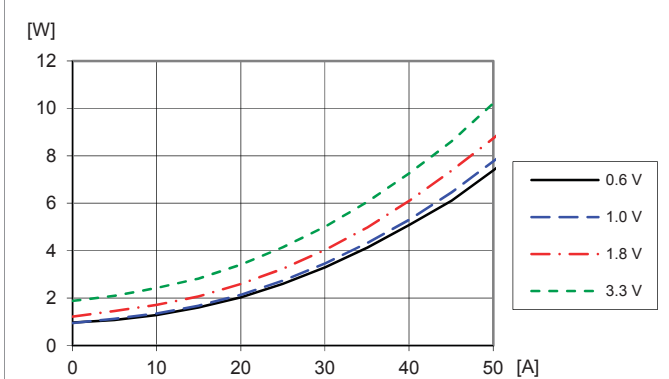

Dissipated power vs. load current and output voltage:  
 $T_{P1} = +25\text{ }^\circ\text{C}$ ,  $V_I = 12\text{ V}$ ,  $f_{sw} = 320\text{ kHz}$ ,  $C_O = 470\text{ }\mu\text{F}/10\text{ m}\Omega$ .

**Efficiency vs. Output Current and Switching Frequency**

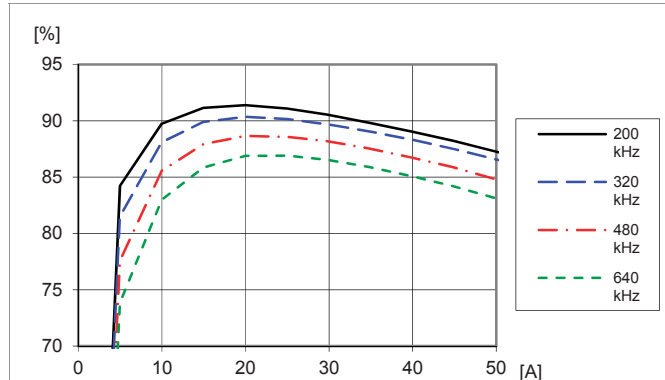

Efficiency vs. load current and switch frequency at  
 $T_{P1} = +25\text{ }^\circ\text{C}$ ,  $V_I = 12\text{ V}$ ,  $V_O = 1.0\text{ V}$ ,  $C_O = 470\text{ }\mu\text{F}/10\text{ m}\Omega$ .  
Default configuration except changed frequency

**Power Dissipation vs. Output Current and Switching Frequency**

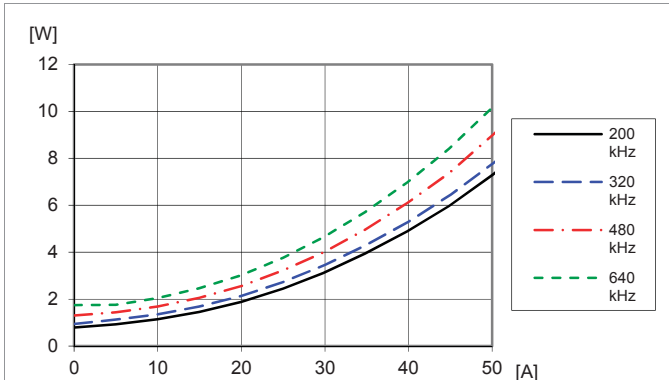

Dissipated power vs. load current and switch frequency at  
 $T_{P1} = +25\text{ }^\circ\text{C}$ ,  $V_I = 12\text{ V}$ ,  $V_O = 1.0\text{ V}$ ,  $C_O = 470\text{ }\mu\text{F}/10\text{ m}\Omega$ .  
Default configuration except changed frequency

**Typical Characteristics**  
**Load Transient**

**Load Transient vs. External Capacitance,  $V_O = 1.0\text{ V}$**

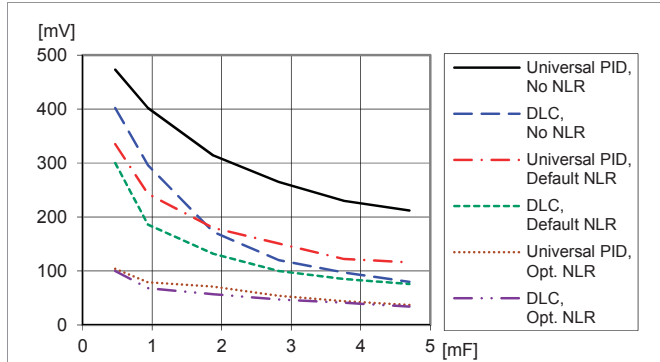

Load transient peak voltage deviation vs. external capacitance.  
Step (12.5-37.5-12.5 A). Parallel coupling of capacitors with 470  $\mu\text{F}/10\text{ m}\Omega$ ,  
 $T_{P1} = +25\text{ }^\circ\text{C}$ ,  $V_I = 12\text{ V}$ ,  $V_O = 1.0\text{ V}$ ,  $f_{sw} = 320\text{ kHz}$ ,  $di/dt = 2\text{ A}/\mu\text{s}$

**Load Transient vs. External Capacitance,  $V_O = 3.3\text{ V}$**

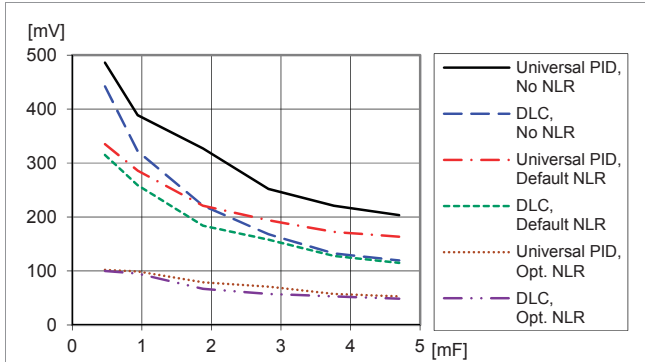

Load transient peak voltage deviation vs. external capacitance.  
Step (12.5-37.5-12.5 A). Parallel coupling of capacitors with 470  $\mu\text{F}/10\text{ m}\Omega$ ,  
 $T_{P1} = +25\text{ }^\circ\text{C}$ ,  $V_I = 12\text{ V}$ ,  $V_O = 3.3\text{ V}$ ,  $f_{sw} = 320\text{ kHz}$ ,  $di/dt = 2\text{ A}/\mu\text{s}$

**Load transient vs. Switch Frequency**

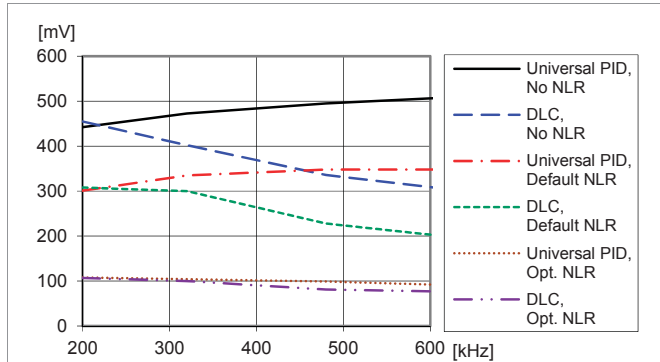

Load transient peak voltage deviation vs. frequency.  
Step-change (12.5-37.5-12.5 A).  
 $T_{P1} = +25\text{ }^\circ\text{C}$ ,  $V_I = 12\text{ V}$ ,  $V_O = 1.0\text{ V}$ ,  $C_O = 470\text{ }\mu\text{F}/10\text{ m}\Omega$

**Output Load Transient Response, Default Configuration**

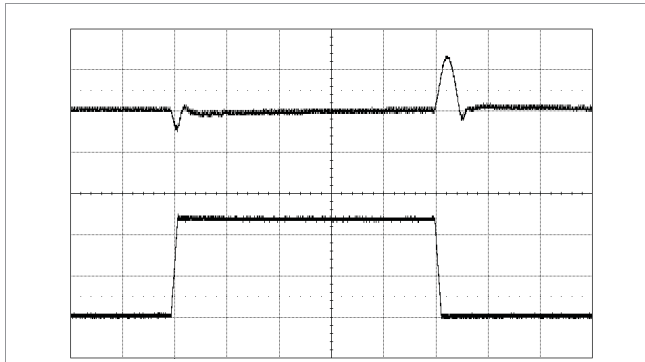

Output voltage response to load Step-change (12.5-37.5-12.5 A) at:  $T_{P1} = +25\text{ }^\circ\text{C}$ ,  $V_I = 12\text{ V}$ ,  $V_O = 1.0\text{ V}$ ,  $di/dt = 2\text{ A}/\mu\text{s}$ ,  $f_{sw} = 320\text{ kHz}$ ,  $C_O = 470\text{ }\mu\text{F}/10\text{ m}\Omega$   
Top trace: output voltage (200 mV/div.).  
Bottom trace: load current (10 A/div.).  
Time scale: (0.1 ms/div.)

Note 1: For Universal PID, see section Dynamic Loop Compensation (DLC).  
Note 2: In these graphs, the worst-case scenario (load step 37.5-12.5 A) has been considered.

**Typical Characteristics**  
**Output Current Characteristic**

**Output Current Derating,  $V_O = 0.6\text{ V}$**

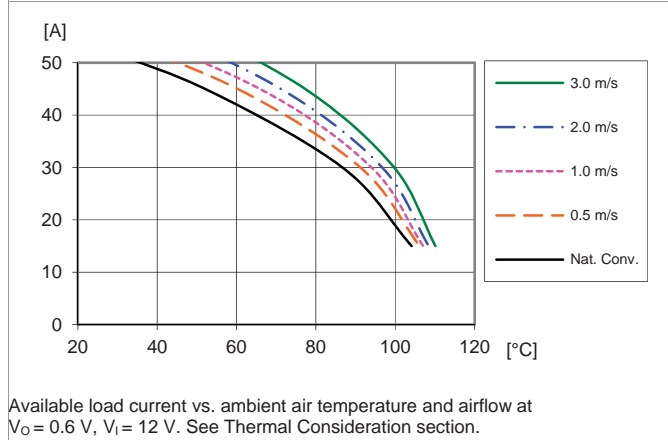

**Output Current Derating,  $V_O = 1.0\text{ V}$**

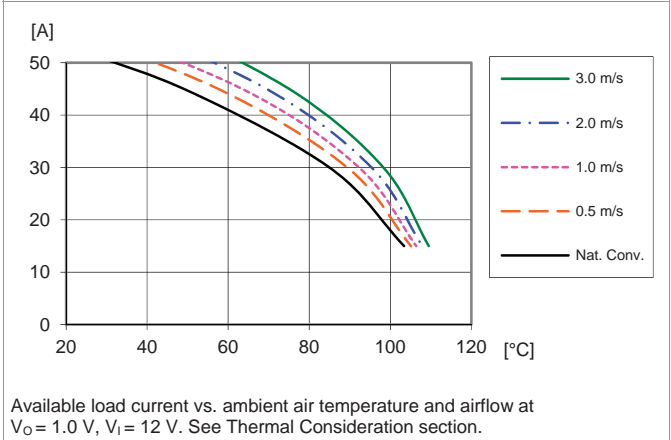

**Output Current Derating,  $V_O = 1.8\text{ V}$**

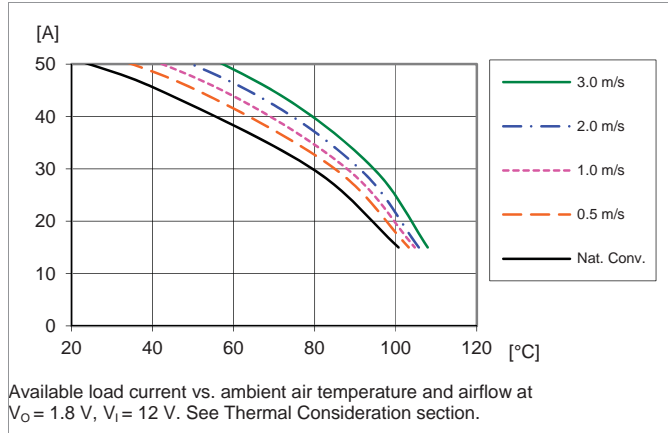

**Output Current Derating,  $V_O = 3.3\text{ V}$**

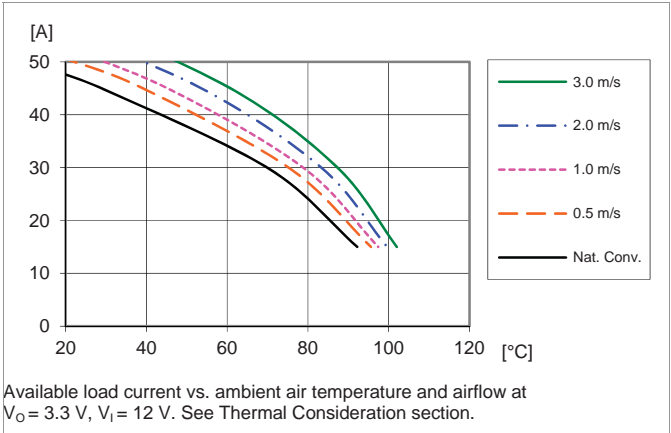

**Current Limit Characteristics,  $V_O = 1.0\text{ V}$**

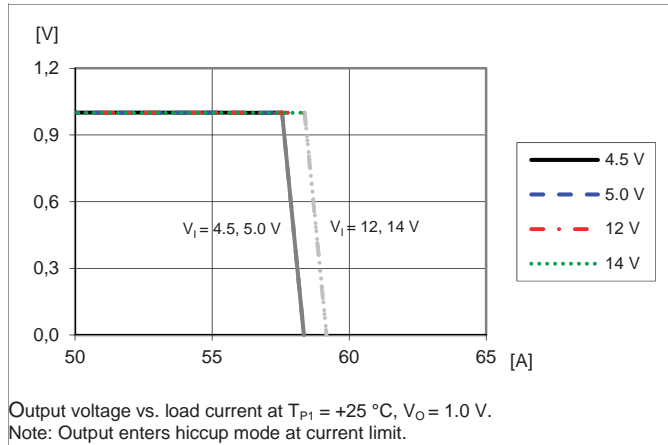

**Current Limit Characteristics,  $V_O = 3.3\text{ V}$**

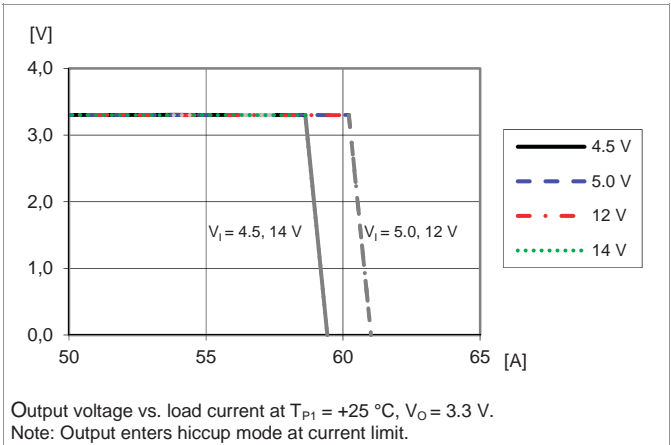



**Typical Characteristics**  
**Output Voltage**

**Output Ripple & Noise,  $V_O = 1.0\text{ V}$**

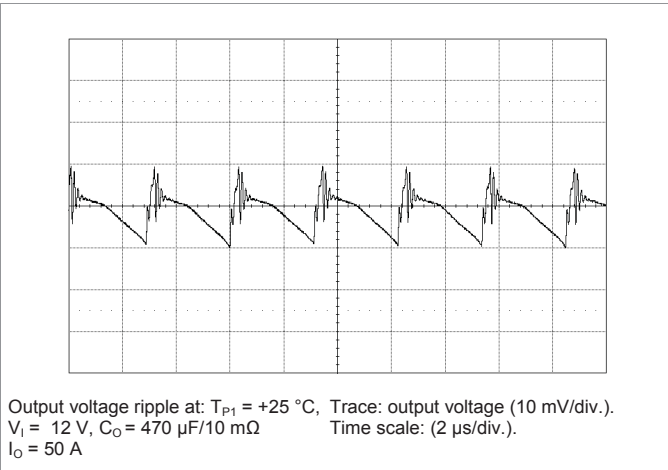

**Output Ripple & Noise,  $V_O = 3.3\text{ V}$**

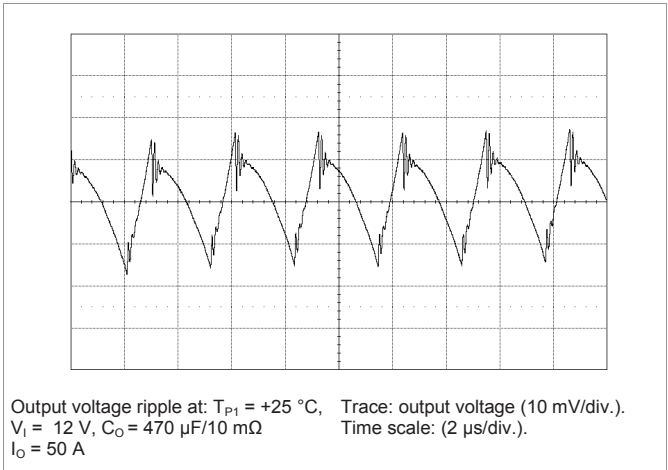

**Output Ripple vs. Input Voltage**

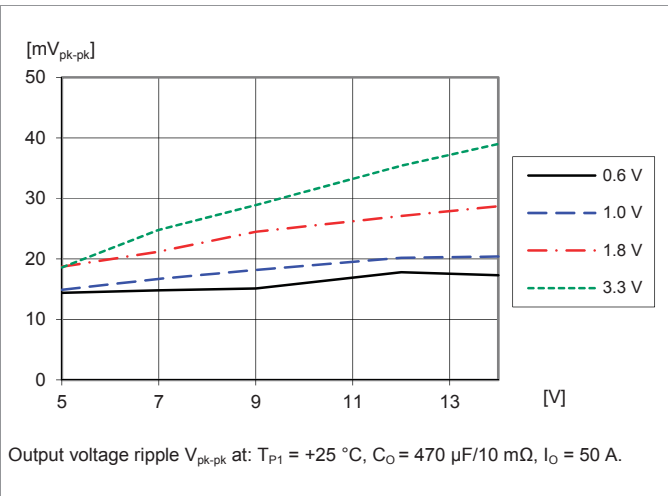

**Output Ripple vs. Frequency**

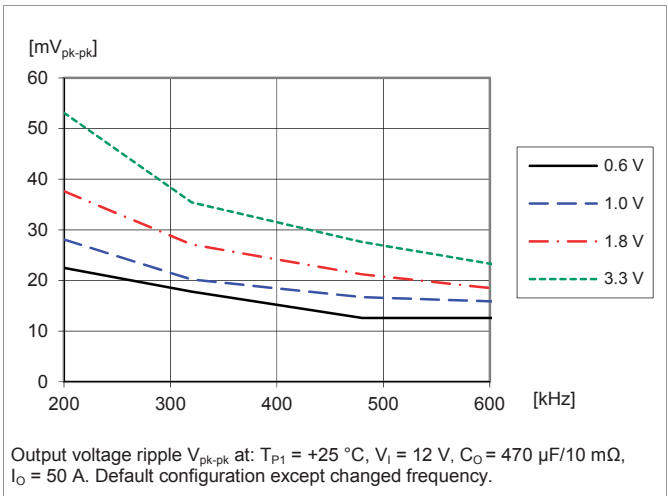

**Output Ripple vs. External Capacitance**

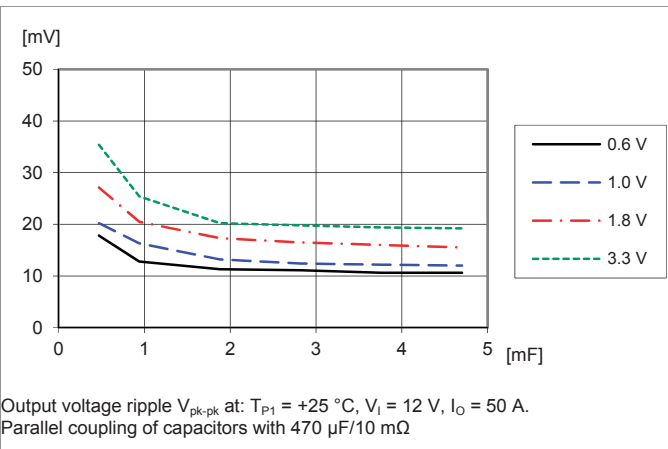

**Load regulation,  $V_O = 1.0\text{ V}$**

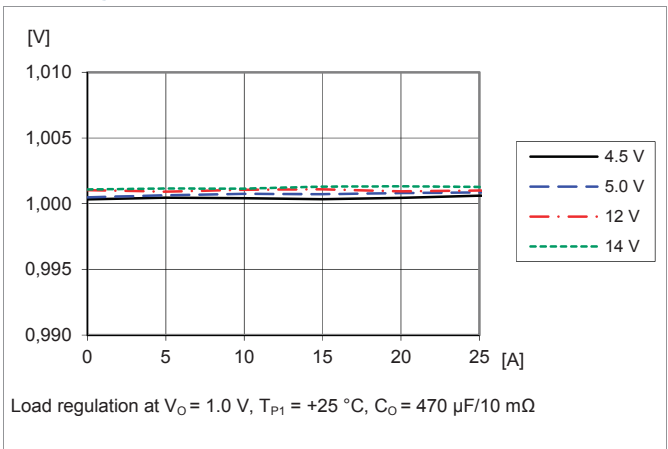

**Typical Characteristics**  
**Start-up and shut-down**

**Start-up by input source**

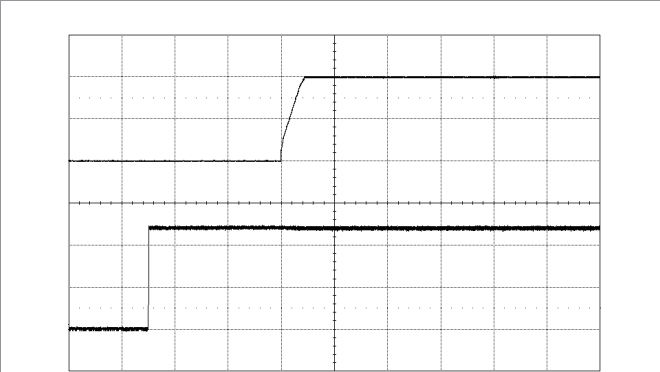

Start-up enabled by connecting  $V_i$  at:  
 $T_{P1} = +25\text{ }^\circ\text{C}$ ,  $V_i = 12\text{ V}$ ,  $V_o = 1.0\text{ V}$   
 $C_o = 470\text{ }\mu\text{F}/10\text{ m}\Omega$ ,  $I_o = 50\text{ A}$   
 Top trace: output voltage (0.5 V/div.).  
 Bottom trace: input voltage (5 V/div.).  
 Time scale: (20 ms/div.).

**Shut-down by input source**

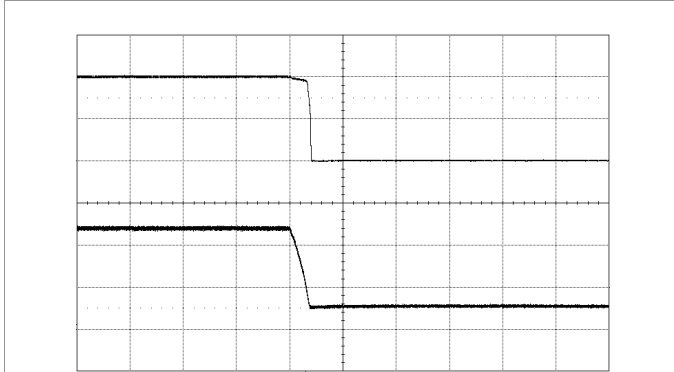

Shut-down enabled by disconnecting  $V_i$  at:  
 $T_{P1} = +25\text{ }^\circ\text{C}$ ,  $V_i = 12\text{ V}$ ,  $V_o = 1.0\text{ V}$   
 $C_o = 470\text{ }\mu\text{F}/10\text{ m}\Omega$ ,  $I_o = 50\text{ A}$   
 Top trace: output voltage (0.5 V/div.).  
 Bottom trace: input voltage (5 V/div.).  
 Time scale: (2 ms/div.).

**Start-up by CTRL signal**

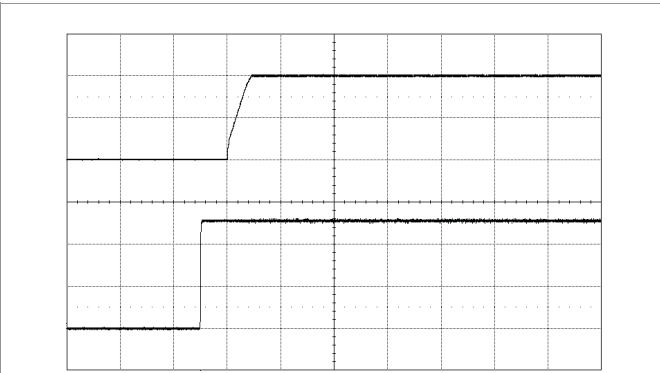

Start-up by enabling CTRL signal at:  
 $T_{P1} = +25\text{ }^\circ\text{C}$ ,  $V_i = 12\text{ V}$ ,  $V_o = 1.0\text{ V}$   
 $C_o = 470\text{ }\mu\text{F}/10\text{ m}\Omega$ ,  $I_o = 50\text{ A}$   
 Top trace: output voltage (0.5 V/div.).  
 Bottom trace: CTRL signal (2 V/div.).  
 Time scale: (20 ms/div.).

**Shut-down by CTRL signal**

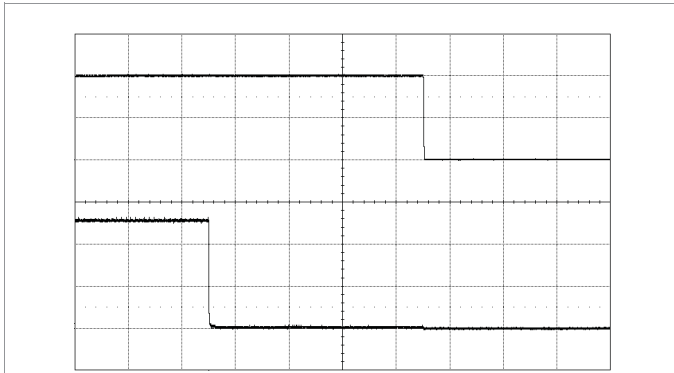

Shut-down enabled by disconnecting  $V_i$  at:  
 $T_{P1} = +25\text{ }^\circ\text{C}$ ,  $V_i = 12\text{ V}$ ,  $V_o = 1.0\text{ V}$   
 $C_o = 470\text{ }\mu\text{F}/10\text{ m}\Omega$ ,  $I_o = 50\text{ A}$   
 Top trace: output voltage (0.5 V/div.).  
 Bottom trace: CTRL signal (2 V/div.).  
 Time scale: (2 ms/div.).

**EMC Specification**

Conducted EMI measured according to test set-up below. The fundamental switching frequency is 320 kHz at  $V_i = 12\text{ V}$ , max IO.

Conducted EMI Input terminal value (typical for default configuration)

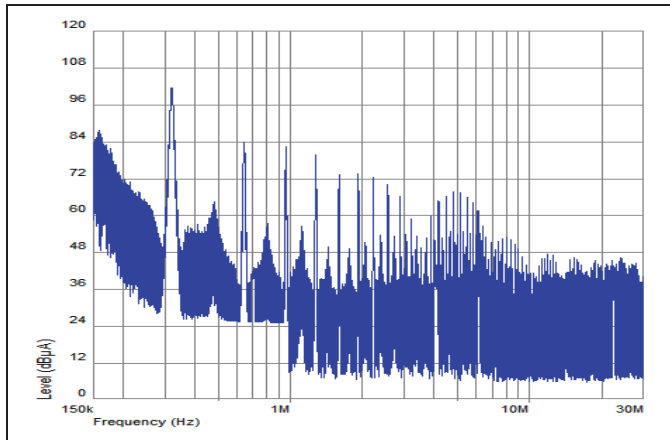

EMI without filter

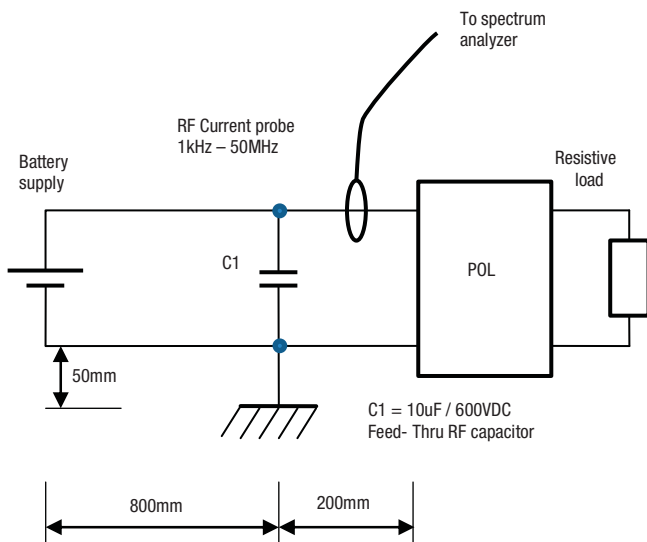

Conducted EMI test set-up

**Layout Recommendations**

The radiated EMI performance of the product will depend on the PWB layout and ground layer design. It is also important to consider the stand-off of the product. If a ground layer is used, it should be connected to the output of the product and the equipment ground or chassis.

A ground layer will increase the stray capacitance in the PWB and improve the high frequency EMC performance.

**Output Ripple and Noise**

Output ripple and noise is measured according to figure below. A 50 mm conductor works as a small inductor forming together with the two capacitors as a damped filter.

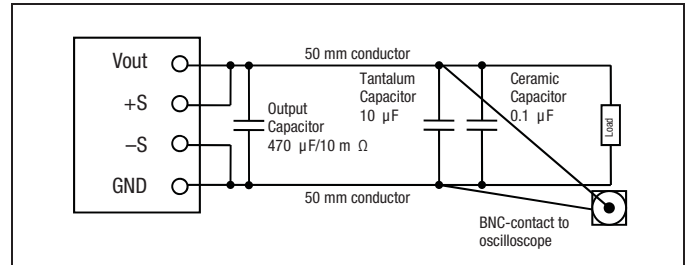

Output ripple and noise test set-up.

**Operating information**

**Power Management Overview**

This product is equipped with a PMBus interface. The product incorporates a wide range of readable and configurable power management features that are simple to implement with a minimum of external components. Additionally, the product includes protection features that continuously safeguard the load from damage due to unexpected system faults. A fault is also shown as an alert on the SALERT pin. The following product parameters can continuously be monitored by a host: Input voltage, output voltage/current, and internal temperature. If the monitoring is not needed it can be disabled and the product enters a low power mode reducing the power consumption. The protection features are not affected.

The product is delivered with a default configuration suitable for a wide range operation in terms of input voltage, output voltage, and load. The configuration is stored in an internal Non-Volatile Memory (NVM). All power management functions can be reconfigured using the PMBus interface. Please contact your local Murata Power Solutions representative for design support of custom configurations or appropriate SW tools for design and download of your own configurations.

**Input Voltage**

The input voltage range, 4.5 - 14 V, makes the product easy to use in intermediate bus applications when powered by a non-regulated bus converter or a regulated bus converter. See Ordering Information for input voltage range.

**Input Under Voltage Lockout, UVLO**

The product monitors the input voltage and will turn-on and turn-off at configured levels. The default turn-on input voltage level setting is 4.20 V, whereas the corresponding turn-off input voltage level is 3.85 V. Hence, the default hys teresis between turn-on and turn-off input voltage is 0.35 V. Once an input turn-off condition occurs, the device can respond in a number of ways as follows:

1. Continue operating without interruption. The unit will continue to operate as long as the input voltage can be supported. If the input voltage continues to fall, there will come a point where the unit will cease to operate.
2. Continue operating for a given delay period, followed by shutdown if the fault still exists. The device will remain in shutdown until instructed to restart.
3. Initiate an immediate shutdown until the fault has been cleared. The user can select a specific number of retry attempts.

The default response from a turn-off is an immediate shutdown of the device. The device will continuously check for the presence of the fault condition. If the fault condition is no longer present, the product will be re-enabled. The turn-on and turn-off levels and response can be reconfigured using the PMBus interface.

**Remote Control**

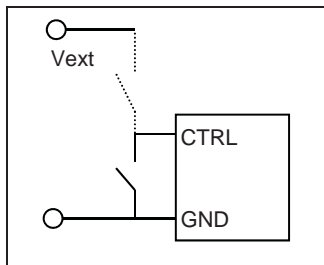

The product is equipped with a remote control function, i.e., the CTRL pin. The remote control can be connected to either the primary negative input connection (GND) or an external voltage (Vext), which is a 3 - 5 V positive supply voltage in accordance to the SMBus Specification version 2.0.

The CTRL function allows the product to be turned on/off by an external device like a semiconductor or mechanical switch. By default the product will turn on when the CTRL pin is left open and turn off when the CTRL pin is applied to GND. The CTRL pin has an internal pull-up resistor. When the CTRL pin is left open, the voltage generated on the CTRL pin is max 5.5 V. If the device is to be synchronized to an external clock source, the clock frequency must be stable prior to asserting the CTRL pin. The product can also be configured using the PMBus interface to be “Always on,” or turn on/off can be performed with PMBus commands.

**Input and Output Impedance**

The impedance of both the input source and the load will interact with the impedance of the product. It is important that the input source has low characteristic impedance. The performance in some applications can be enhanced by addition of external capacitance as described under External Decoupling Capacitors. If the input voltage source contains significant inductance, the addition a capacitor with low ESR at the input of the product will ensure stable operation.

**External Capacitors**

Input capacitors:

The input ripple RMS current in a buck converter is equal to

$$I_{inputRMS} = I_{load} \sqrt{D(1-D)},$$

where  $I_{load}$  is the output load current and  $D$  is the duty cycle. The maximum load ripple current becomes  $I_{load}/2$ . The ripple current is divided into three parts, i.e., currents in the input source, external input capacitor, and internal input capacitor. How the current is divided depends on the impedance of the input source, ESR and capacitance values in the capacitors. A minimum capacitance of 300  $\mu$ F with low ESR is recommended. The ripple current rating of the capacitors must follow Eq. 1. For high-performance/transient applications or wherever the input source performance is degraded, additional low ESR ceramic type capacitors at the input is recommended. The additional input low ESR capacitance above the minimum level insures an optimized performance.

Output capacitors:

When powering loads with significant dynamic current requirements, the voltage regulation at the point of load can be improved by addition of decoupling capacitors at the load.

The most effective technique is to locate low ESR ceramic and electrolytic capacitors as close to the load as possible, using several capacitors in parallel to lower the effective ESR. The ceramic capacitors will handle high-frequency dynamic load changes while the electrolytic capacitors are used to handle low frequency dynamic load changes. Ceramic capacitors will also reduce high frequency noise at the load.

It is equally important to use low resistance and low inductance PWB layouts and cabling.

External decoupling capacitors are a part of the control loop of the product and may affect the stability margins.

Stable operation is guaranteed for the following total capacitance  $C_O$  in the output decoupling capacitor bank where

$$\text{Eq. 2. } C_O = [C_{min}, C_{max}] = [470, 30000] \mu\text{F.}$$

The decoupling capacitor bank should consist of capacitors which has a capacitance value larger than  $C \geq C_{min}$  and has an ESR range of

$$\text{Eq. 3. } ESR = [ESR_{min}, ESR_{max}] = [5, 30] \text{ m}\Omega$$

The control loop stability margins are limited by the minimum time constant  $\tau_{min}$  of the capacitors. Hence, the time constant of the capacitors should follow Eq. 4.

$$\text{Eq. 4. } \tau \geq \tau_{min} = C_{min} ESR_{min} = 2.35 \mu\text{s}$$

This relation can be used if your preferred capacitors have parameters outside the above stated ranges in Eq. 2 and Eq.3.

- If the capacitors capacitance value is  $C < C_{min}$  one must use at least  $N$  capacitors where 
$$N \geq \left\lceil \frac{C_{min}}{C} \right\rceil \text{ and } ESR \geq ESR_{min} \frac{C_{min}}{C} .$$
- If the ESR value is  $ESR > ESR_{max}$  one must use at least  $N$  capacitors of that type where

$$N \geq \left\lceil \frac{ESR}{ESR_{max}} \right\rceil \text{ and } C \geq \frac{C_{min}}{N}.$$

- If the *ESR* value is  $ESR < ESR_{min}$  the capacitance value should be

$$C \geq C_{min} \frac{ESR_{min}}{ESR}.$$

For a total capacitance outside the above stated range or capacitors that do not follow the stated above requirements above a re-design of the control loop parameters will be necessary for robust dynamic operation and stability.

### Control Loop

The product uses a voltage-mode synchronous buck controller with a fixed frequency PWM scheme. Although the product uses a digital control loop, it operates much like a traditional analog PWM controller. As in the analog controller case, the control loop compares the output voltage to the desired voltage reference and compensation is added to keep the loop stable and fast. The resulting error signal is used to drive the PWM logic. Instead of using external resistors and capacitors required with traditional analog control loops, the product uses a digital Proportional-Integral-Derivative (PID) compensator in the control loop. The characteristics of the control loop is configured by setting PID compensation parameters. These PID settings can be reconfigured using the PMBus interface.

### Dynamic Loop Compensation (DLC)

The DLC feature might in some documents be referred to as “Auto Compensation” or “Auto Tuning” feature.

The DLC feature measures the characteristics of the power train and calculates the proper compensator PID coefficients.

The default configuration is that once the output voltage ramp up has completed, the DLC algorithm will begin and a new optimized compensator solution (PID setting) will be found and implemented. The DLC algorithm typically takes between 50 ms and 200 ms to complete. By the PMBus command `AUTO_COMP_CONFIG` the user may select between several different modes of operation:

- Disable
- Autocomp once, will run DLC algorithm each time the output is enabled (default configuration)
- Autocomp every second will initiate a new DLC algorithm each 1 second
- Autocomp every minute will initiate a new DLC algorithm every minute.

The DLC can also be configured to run once only after the first ramp up (after input power have been applied) and to use that temporary stored PID settings in all subsequent ramps. If input power is cycled a new DLC algorithm will be performed after the first ramp up. The default setting is however to run the DLC algorithm after every ramp up.

The DLC algorithm can also be initiated manually by sending the `AUTO_COMP_CONTROL` command.

The DLC can also be configured with Auto Comp Gain Control. This scales the DLC results to allow a trade-off between transient response and steady-state duty cycle jitter. A setting of 100% will provide the fastest transient response while a setting of 10% will produce the lowest jitter. The default is 50%.

### Changing DLC and PID Setting

Some caution must be considered while DLC is enabled and when it is changed from enabled or disabled.

When operating, the controller IC uses the settings loaded in its (volatile) RAM memory. When the input power is applied the RAM settings are retrieved from the pin-strap resistors and the two non-volatile memories (DEFAULT and USER). The sequence is described in the “Initialization Procedure” section.

#### When DLC is enabled:

When DLC is enabled, the normal sequence (after input power has been applied) that a value stored in the user non-volatile memory overwrites any previously loaded value does not apply for the PID setting (stored in the `PID_TAPS` register). The PID setting in the user non-volatile memory is ignored and a non-configurable default PID setting is loaded to RAM to act as a safe starting value for the DLC. Once the output has been enabled and the DLC algorithm has found a new optimized PID setting, it will be loaded in RAM and used by the control loop.

When saving changes to the user non-volatile memory, all changes made to the content of RAM will be saved. This also includes the default PID setting (loaded to RAM to act as a safe starting value) or the PID setting changed by the DLC algorithm after enabling output. The result is that as long as DLC is enabled the PID setting in the user non-volatile memory is ignored, but it might accidentally get overwritten.

#### When changing DLC from disabled to enabled:

A non-configurable default PID setting is loaded to RAM to act as a safe starting value for the DLC (same as above).

#### When changing DLC from enabled to disabled:

When changing DLC from enabled to disabled, the PID setting in the user non-volatile memory will be loaded to RAM. Any new optimized PID setting in RAM will be lost, if not first stored to the user non-volatile memory.

#### When DLC is disabled:

When DLC is disabled and input power has been applied, the PID setting in the user non-volatile memory will be loaded to RAM and used in the control loop.

The original PID setting in the user non-volatile memory is quite slow and not recommended for optimal performance. If DLC is disabled it is recommended to either:

1. Use the DLC to find optimized PID setting.
2. Use Ericsson Power Designer to find appropriate PID setting.
3. Use Universal PID as defined below.

The Universal PID setting (taps) is:

A = 3289.56,  
B = -6248.12,  
C = 2964.06

Write 0x7CB941FDC3417CCD99 to PID\_TAPS register and write command STORE\_USER\_ALL

Note that if DLC is enabled, for best results VI must be stable before DLC algorithm begins.

### Load Transient Response Optimization

The product incorporates a Non-Linear transient Response, NLR, loop that decreases the response time and the output voltage deviation during a load transient. The NLR results in a higher equivalent loop bandwidth than is possible using a traditional linear control loop. The product is pre-configured with appropriate NLR settings for robust and stable operation for a wide range of input voltage and a capacitive load range as defined in the section External Decoupling Capacitors. For an application with a specific input voltage, output voltage, and capacitive load, the NLR configuration can be optimized for a robust and stable operation and with an improved load transient response. This will also reduce the amount of output decoupling capacitors and yield a reduced cost. However, the NLR slightly reduces the efficiency. In order to obtain maximal energy efficiency the load transient requirement has to be met by the standard control loop compensation and the decoupling capacitors. The NLR settings can be reconfigured using the PMBus interface.

### Remote Sense

The product has remote sense that can be used to compensate for voltage drops between the output and the point of load. The sense traces should be located close to the PWB ground layer to reduce noise susceptibility. Due to derating of internal output capacitance the voltage drop should be kept below  $V_{DROP\,MAX} = (5.5 - V_O)/2$ . A large voltage drop will impact the electrical performance of the regulator. If the remote sense is not needed, +S should be connected to VOUT and -S should be connected to GND.

### Output Voltage Adjust using Pin-strap Resistor

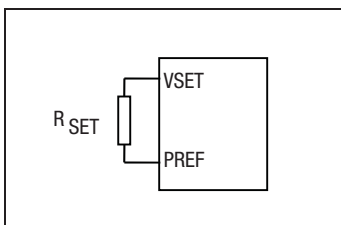

Using an external Pin-strap resistor, RSET, the output voltage can be set in the range 0.6 V to 3.3 V at 28 different levels shown in the table below. The resistor should be applied between the VSET pin and the PREF pin.

RSET also sets the maximum output voltage, see section "Output Voltage Range Limitation." The resistor is sensed only during product start-up. Changing the resistor value during normal operation will not change the output voltage. The input voltage must be at least 1 V larger than the output voltage in order to deliver the correct output voltage. See Ordering Information for output voltage range.

The following table shows recommended resistor values for RSET. Maximum 1% tolerance resistors are required.

V <sub>O</sub> [V]	R <sub>SET</sub> [kΩ]	V <sub>O</sub> [V]	R <sub>SET</sub> [kΩ]
0.60	10	1.50	46.4
0.65	11	1.60	51.1
0.70	12.1	1.70	56.2
0.75	13.3	1.80	61.9
0.80	14.7	1.90	68.1
0.85	16.2	2.00	75
0.90	17.8	2.10	82.5
0.95	19.6	2.20	90.9
1.00	21.5	2.30	100
1.05	23.7	2.50	110
1.10	26.1	3.00	121
1.15	28.7	3.30	133
1.20	31.6		
1.25	34.8		
1.30	38.3		
1.40	42.2		

The output voltage and the maximum output voltage can be pin strapped to three fixed values by connecting the VSET pin according to the table below.

V <sub>O</sub> [V]	VSET
0.60	Shorted to PREF
1.2	Open "high impedance"
2.5	Logic High, GND as reference

### Output Voltage Adjust using PMBus

The output voltage set by pin-strap can be overridden by configuration file or by using a PMBus command. See Electrical Specification for adjustment range.

When setting the output voltage by configuration file or by a PMBus command, the specified output voltage accuracy is valid only when the set output voltage level falls within the same bin range as the voltage level defined by the pin-strap resistor RSET. The applicable bin ranges are defined in the table below. Valid accuracy for voltage levels outside the applicable bin range is two times the specified.

### Example:

Nominal V<sub>O</sub> is set to 1.10 V by RSET = 26.1 kΩ. 1.10 V falls within the bin range 0.988-1.383 V, thus specified accuracy is valid when adjusting V<sub>O</sub> within 0.988-1.383V.

V <sub>O</sub> bin ranges [V]
0.600 – 0.988
0.988 – 1.383
1.383 – 1.975
1.975 – 2.398
2.398 – 2.963
2.963 – 3.753

### Output Voltage Range Limitation

The output voltage range that is possible to set by configuration or by the PMBus interface is limited by the pin-strap resistor RSET. The maximum output voltage is set to 110% of the nominal output value defined by RSET,  $V_{O,MAX} = 1.1 \times V_{O,RSET}$ . This protects the load from an over voltage due to an accidental wrong PMBus command.

### Output Voltage Adjust Limitation using PMBus

In addition to the maximum output voltage limitation by the pin-strap resistor RSET, there is also a limitation in how much the output voltage can be increased while the output is enabled. If output is disabled then RSET resistor is the only limitation.

#### Example:

If the output is enabled with output voltage set to 1.0 V, then it is only possible to adjust/change the output voltage up to 1.7- V as long as the output is enabled.

V <sub>o</sub> setting when enabled [V]	V <sub>o</sub> set range while enabled [V]
0.000 – 0.988	~0.2 to >1.2
0.988 – 1.383	~0.2 to >1.7
1.383 – 1.975	~0.2 to >2.5
1.975 – 2.398	~0.2 to >2.97
2.398 – 2.963	~0.2 to >3.68
2.963 – 3.753	~0.2 to >4.65

### Over Voltage Protection (OVP)

The product includes over voltage limiting circuitry for protection of the load. The default OVP limit is 15% above the nominal output voltage. If the output voltage exceeds the OVP limit, the product can respond in different ways:

1. Initiate an immediate shutdown until the fault has been cleared. The user can select a specific number of retry attempts.
2. Turn off the high-side MOSFET and turn on the low-side MOSFET. The low-side MOSFET remains ON until the device attempts a restart, i.e. the output voltage is pulled to ground level (crowbar function).

The default response from an overvoltage fault is to immediately shut down as in 2. The device will continuously check for the presence of the fault condition, and when the fault condition no longer exists the device will be re-enabled. For continuous OVP when operating from an external clock for synchronization, the only allowed response is an immediate shutdown. The OVP limit and fault response can be reconfigured using the PMBus interface.

### Under Voltage Protection (UVP)

The product includes output under voltage limiting circuitry for protection of the load. The default UVP limit is 15% below the nominal output voltage. The UVP limit can be reconfigured using the PMBus interface.

### Power Good

The product provides a Power Good (PG) flag in the Status Word register that indicates the output voltage is within a specified tolerance of its target level and no fault condition exists. If specified in section Connections, the product also provides a PG signal output. The PG pin is active high and by default open-drain but may also be configured as push-pull via the PMBus interface.

By default, the PG signal will be asserted when the output reaches above 90% of the nominal voltage, and de-asserted when the output

falls below 85% of the nominal voltage. These limits may be changed via the PMBus interface. A PG delay period is defined as the time from when all conditions within the product for asserting PG are met to when the PG signal is actually asserted. The default PG delay is set to 10 ms. This value can be reconfigured using the PMBus interface.

For products with DLC the PG signal is by default asserted directly after the DLC operation have been completed. If DLC is disabled the configured PG delay will be used. This can be reconfigured using the PMBus interface.

### Switching Frequency

The fundamental switching frequency is 320 kHz, which yields optimal power efficiency. The switching frequency can be set to any value between 200 kHz and 640 kHz using the PMBus interface. The switching frequency will change the efficiency/power dissipation, load transient response and output ripple. For optimal control loop performance in a product without DLC, the control loop must be re-optimized when changing the switching frequency.

### Synchronization

Synchronization is a feature that allows multiple products to be synchronized to a common frequency. Synchronized products powered from the same bus eliminate beat frequencies reflected back to the input supply, and also reduces EMI filtering requirements. Eliminating the slow beat frequencies (usually <10 kHz) allows the EMI filter to be designed to attenuate only the synchronization frequency. Synchronization can also be utilized for phase spreading, described in section Phase Spreading.

The products can be synchronized with an external oscillator or one product can be configured with the SYNC pin as a SYNC Output working as a master driving the synchronization. All others on the same synchronization bus must be configured with SYNC Input. Default configuration is using the internal clock, independently of signal at the SYNC pin.

### Phase Spreading

When multiple products share a common DC input supply, spreading of the switching clock phase between the products can be utilized. This dramatically reduces input capacitance requirements and efficiency losses, since the peak current drawn from the input supply is effectively spread out over the whole switch period. This requires that the products are synchronized. Up to 16 different phases can be used.

The phase spreading of the product can be configured using the PMBus interface.

### Parallel Operation (Current Sharing)

Paralleling multiple products can be used to increase the output current capability of a single power rail. By connecting the GCB pins of each device and configuring the devices as a current sharing rail, the units will share the current equally, enabling up to 100% utilization of the current capability for each device in the current sharing rail. The product uses a low-bandwidth, first-order digital current sharing by

aligning the output voltage of the slave devices to deliver the same current as the master device. Artificial droop resistance is added to the output voltage path to control the slope of the load line curve, calibrating out the physical parasitic mismatches due to power train components and PWB layout. Up to 7 devices can be configured in a given current sharing group.

In order to avoid interference with other algorithms executing during parallel operation, the dead-time algorithm should be turned off and fixed dead-times be used.

### Phase Adding and Shedding for Parallel Operation

During periods of light loading, it may be beneficial to disable one or more phases (modules) in order to eliminate the current drain and switching losses associated with those phases, resulting in higher efficiency. The product offers the ability to add and drop phases (modules) using a PMBus command in response to an observed load current change. All phases (modules) in a current share rail are considered active prior to the current sharing rail ramp to power-good. Phases can be dropped after power-good is reached. Any member of the current sharing rail can be dropped. If the reference module is dropped, the remaining active module with the lowest member position will become the new reference. Additionally, any change to the number of members of a current sharing rail will precipitate autonomous phase distribution within the rail where all active phases realign their phase position based on their order within the number of active members. If the members of a current sharing rail are forced to shut down due to an observed fault, all members of the rail will attempt to re-start simultaneously after the fault has cleared.

### Efficiency Optimized Dead Time Control

The product utilizes a closed loop algorithm to optimize the dead-time applied between the gate drive signals for the switch and synch FETs. The algorithm constantly adjusts the deadtime non-overlap to minimize the duty cycle, thus maximizing efficiency. This algorithm will null out deadtime differences due to component variation, temperature and loading effects. The algorithm can be configured via the PMBus interface.

### Over Current Protection (OCP)

The product includes current limiting circuitry for protection at continuous overload. The following OCP response options are available:

1. Initiate a shutdown and attempt to restart an infinite number of times with a preset delay period between attempts.
2. Initiate a shutdown and attempt to restart a preset number of times with a preset delay period between attempts.
3. Continue operating for a given delay period, followed by shutdown if the fault still exists.
4. Continue operating through the fault (this could result in permanent damage to the power supply).
5. Initiate an immediate shutdown.

The default response from an over current fault is an immediate

shutdown of the device. The device will continuously check for the presence of the fault condition, and if the fault condition no longer exists the device will be re-enabled. The load distribution should be designed for the maximum output short circuit current specified. The OCP limit and response of the product can be reconfigured using the PMBus interface.

### Initialization Procedure

The product follows a specific internal initialization procedure after power is applied to the VIN pin:

1. Status of the address and output voltage pin-strap pins are checked and values associated with the pin settings are loaded to RAM.
2. Values stored in the Murata default non-volatile memory are loaded to RAM. This overwrites any previously loaded values.
3. Values stored in the user non-volatile memory are loaded to RAM. This overwrites any previously loaded values.

Once the initialization process is completed, the product is ready to be enabled using the CTRL pin. The product is also ready to accept commands via the PMBus interface, which will overwrite any values loaded during the initialization procedure.

### Soft-start Power Up

The soft-start control introduces a time-delay before allowing the output voltage to rise. Once the initialization time has passed the device will wait for the configured delay period prior to starting to ramp its output. After the delay period has expired, the output will begin to ramp towards its target voltage according to the configured soft-start ramp time.

The default settings for the soft-start delay period and the soft-start ramp time is 10 ms. Hence, power-up is completed within 20 ms in default configuration using remote control. When the soft-start delay time is set to 0 ms, the module will begin its ramp-up after the internal circuitry has initialized (approximately 2 ms). It is generally recommended to set the soft-start ramp-up time to a value greater than 500  $\mu$ s to prevent inadvertent fault conditions due to excessive inrush current. The actual minimum ramp-up time will however normally be limited by the control loop settings and ramp-up times of internal interface voltages in the controller circuit to approximately 2 ms. The soft-start power up of the product can be reconfigured using the PMBus interface.

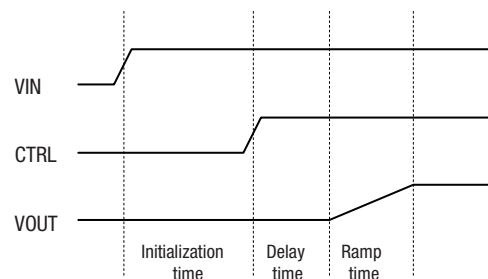

Illustration of Power Up Procedure



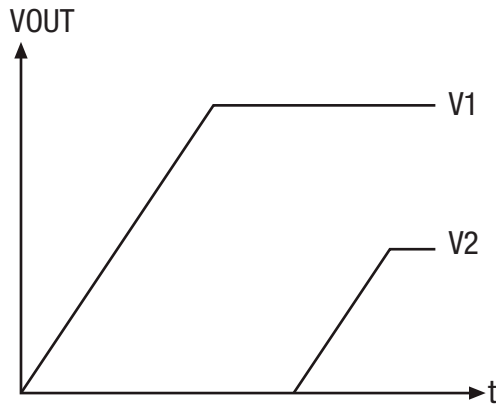

Illustration of Output Voltage Sequencing.

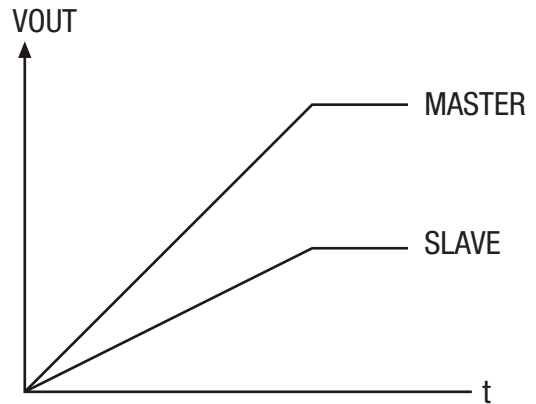

Illustration of Ratiometric Voltage Tracking

### Output Voltage Sequencing

A group of products may be configured to power up in a predetermined sequence. This feature is especially useful when powering advanced processors, FPGAs, and ASICs that require one supply to reach its operating voltage prior to another. Multi-product sequencing can be achieved by configuring the start delay and rise time of each device through the PMBus interface and by using the CTRL start signal.

### Voltage Tracking

The product integrates a lossless tracking scheme that allows its output to track a voltage that is applied to the VTRK pin with no external components required. During ramp-up, the output voltage follows the VTRK voltage until the preset output voltage level is met. The product offers two modes of tracking as follows:

1. Coincident. This mode configures the product to ramp its output voltage at the same rate as the voltage applied to the VTRK pin.

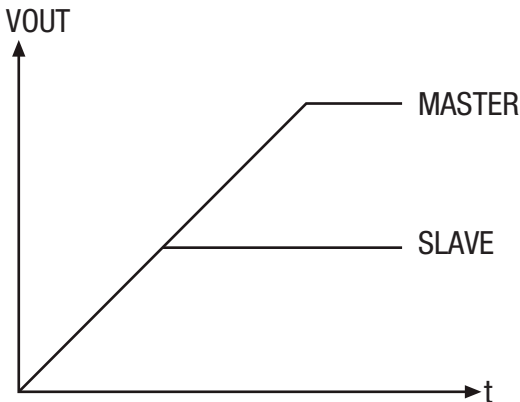

Illustration of Coincident Voltage Tracking.

2. Ratiometric. This mode configures the product to ramp its output voltage at a rate that is a percentage of the voltage applied to the VTRK pin. The default setting is 50%, but a different tracking ratio may be set by an external resistive voltage divider or through the PMBus interface.

The master device in a tracking group is defined as the device that has the highest target output voltage within the group. This master device will control the ramp rate of all tracking devices and is not configured for tracking mode. All of the CTRL pins in the tracking group must be connected and driven by a single logic source. It should be noted that current sharing groups that are also configured to track another voltage do not offer pre-bias protection; a minimum load should therefore be enforced to avoid the output voltage from being held up by an outside force.

### Voltage Margining Up/Down

The product can adjust its output higher or lower than its nominal voltage setting in order to determine whether the load device is capable of operating over its specified supply voltage range. This provides a convenient method for dynamically testing the operation of the load circuit over its supply margin or range. It can also be used to verify the function of supply voltage supervisors. Margin limits of the nominal output voltage  $\pm 5\%$  are default, but the margin limits can be reconfigured using the PMBus interface.

### Pre-Bias Startup Capability

Pre-bias startup often occurs in complex digital systems when current from another power source is fed back through a dual-supply logic component, such as FPGAs or ASICs. The product family incorporates synchronous rectifiers, but will not sink current during startup, or turn off, or whenever a fault shuts down the product in a pre-bias condition. Pre-bias protection is not offered for current sharing groups that also have voltage tracking enabled.

### Group Communication Bus

The Group Communication Bus, GCB, is used to communicate between products. This dedicated bus provides the communication channel between devices for features such as sequencing, fault spreading, and current sharing. The GCB solves the PMBus data rate limitation. The GCB pin on all devices in an application should be connected together. A pull-up resistor is required on the common GCB in order to guarantee the rise time as follows:

Eq. 5.  $\tau = R_{GCB} C_{GCB} \leq 1 \mu s$ ,

where  $R_{GCB}$  is the pull up resistor value and  $C_{GCB}$  is the bus loading. The pull-up resistor should be tied to an external supply voltage in range from 3.3 to 5 V, which should be present prior to or during power-up.

If exploring untested compensation or deadtime configurations, it is recommended that 27  $\Omega$  series resistors are placed between the GCB pin of each product and the common GCB connection. This will avoid propagation of faults between products potentially caused by hazardous configuration settings. When the configurations of the products are settled the series resistors can be removed.

The GCB is an internal bus, such that it is only connected across the modules and not the PMBus system host. GCB addresses are assigned on a rail level, i.e. modules within the same current sharing group share the same GCB address. Addressing rails across the GCB is done with a 5 bit GCB ID, yielding a theoretical total of 32 rails that can be shared with a single GCB bus.

### Fault spreading

The product can be configured to broadcast a fault event over the GCB bus to the other devices in the group. When a non-destructive fault occurs and the device is configured to shut down on a fault, the device will shut down and broadcast the fault event over the GCB bus. The other devices on the GCB bus will shut down together if configured to do so, and will attempt to re-start in their prescribed order if configured to do so.

### Over Temperature Protection (OTP)

The products are protected from thermal overload by an internal over temperature shutdown function in the controller circuit N1, located at position P2 (see section Thermal Consideration). Some of the products that this specification covers use the temperature at position P2 (TP2) as a reference for specified OTP threshold and some use position P1 (TP1) as a reference for specified OTP threshold. See the Over Temperature Protection section in the electrical specification for each product.

#### Products with P1 as reference for OTP:

When TP1 as defined in thermal consideration section exceeds approximately 120 °C the product will shut down. The specified OTP threshold and hysteresis are valid for worst case operation regarding cooling conditions, input voltage and output voltage. The actually configured default value in the controller circuit in position P2 is 110 °C, but at worst case operation the temperature is approximately 10 °C higher at position P1. At light load the temperature is approximately the same in position P1 and P2. This means the OTP threshold and hysteresis will be lower at light load conditions when P1 is used as a reference for OTP.

#### Products with P2 as reference OTP:

When TP2 as defined in thermal consideration section exceeds 120°C the product will shut down. For products with P2 as a reference for OTP the configured default value in the controller circuit in position P2 is 120°C.

The OTP threshold, hysteresis, and fault response of the product can be reconfigured using the PMBus interface. The fault response can be configured as follows:

1. Initiate a shutdown and attempt to restart an infinite number of times with a preset delay period between attempts (default configuration).
2. Initiate a shutdown and attempt to restart a preset number of times with a preset delay period between attempts.
3. Continue operating for a given delay period, followed by shutdown if the fault still exists.
4. Continue operating through the fault (this could result in permanent damage to the power supply).
5. Initiate an immediate shutdown.

### Optimization examples

This product is designed with a digital control circuit. The control circuit uses a configuration file which determines the functionality and performance of the product. It is possible to change the configuration file to optimize certain performance characteristics. In the table below is a schematic view on how to change different configuration parameters in order to achieve an optimization towards a wanted performance.

↑	Increase
→	No change
↓	Decrease

Config. parameters	Switching frequency	Control loop bandwidth	NLR threshold	Diode emulation (DCM)	Min. pulse
Optimized performance					
Maximize efficiency	↓	→	↑	Enable	Disable
Minimize ripple ampl.	↑	→	↑	Enable or disable	Enable or disable
Improve load transient response	↑	↑	↓	Disable	Disable
Minimize idle power loss	↓	↑	→	Enable	Enable

Note 1: The following table, graphs, and waveforms are only examples and valid for OKDX-T/50-W12-001-C.

Note 2: In the following table and graphs, the worst-case scenario (load step 37.5-12.5 A) has been considered for load transient.

$P_{II}$	Input idling power (no load)	Default configuration: Continuous Conduction Mode, CCM	$V_o = 0.6\text{ V}$	0.95	W
			$V_o = 1.0\text{ V}$	0.95	
			$V_o = 1.8\text{ V}$	1.22	
			$V_o = 3.3\text{ V}$	1.88	
		DCM, Discontinuous Conduction Mode (diode emulation)	$V_o = 0.6\text{ V}$	0.21	W
			$V_o = 1.0\text{ V}$	0.21	
			$V_o = 1.8\text{ V}$	0.21	
			$V_o = 3.3\text{ V}$	0.21	
		DCM with Minimum Pulse Enabled	$V_o = 0.6\text{ V}$	0.43	W
			$V_o = 1.0\text{ V}$	0.46	
			$V_o = 1.8\text{ V}$	0.54	
			$V_o = 3.3\text{ V}$	0.67	
$P_{CTRL}$	Input standby power	Turned off with CTRL-pin	Default configuration: Monitoring enabled	170	mW
			Pulse monitor mode: Monitoring disabled	109	mW
			Low power mode: Monitoring disabled	85	mW
$V_{tr1}$	Load transient peak voltage deviation	Default configuration $di/dt = 2\text{ A}/\mu\text{s}$ $C_o = 470\text{ }\mu\text{F}$	$V_o = 0.6\text{ V}$	300	mV
			$V_o = 1.0\text{ V}$	300	
			$V_o = 1.8\text{ V}$	305	
			$V_o = 3.3\text{ V}$	315	
	Load step 25-75-25% of max $I_o$	DLC and Optimized NLR configuration $di/dt = 2\text{ A}/\mu\text{s}$ $C_o = 470\text{ }\mu\text{F}$	$V_o = 0.6\text{ V}$	100	mV
			$V_o = 1.0\text{ V}$	100	
$t_{tr1}$	Load transient recovery time	Default configuration $di/dt = 2\text{ A}/\mu\text{s}$ $C_o = 470\text{ }\mu\text{F}$	$V_o = 0.6\text{ V}$	100	$\mu\text{s}$
			$V_o = 1.0\text{ V}$	100	
			$V_o = 1.8\text{ V}$	100	
			$V_o = 3.3\text{ V}$	100	
	Load step 25-75-25% of max $I_o$	DLC and Optimized NLR configuration $di/dt = 2\text{ A}/\mu\text{s}$ $C_o = 470\text{ }\mu\text{F}$	$V_o = 0.6\text{ V}$	50	
			$V_o = 1.0\text{ V}$	50	
			$V_o = 1.8\text{ V}$	50	
			$V_o = 3.3\text{ V}$	50	

Efficiency vs. Output Current and Switching frequency

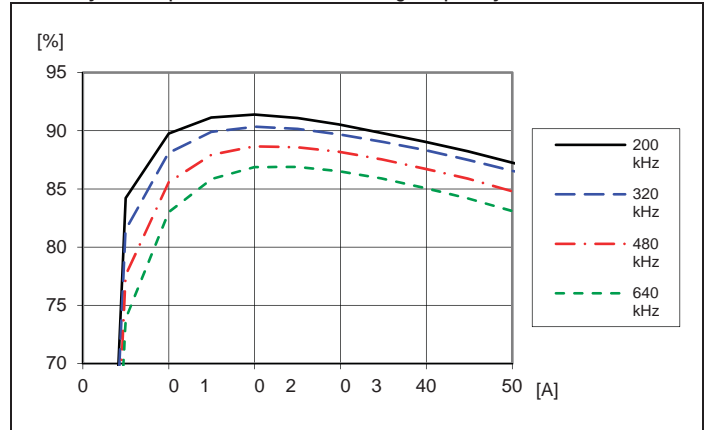

Efficiency vs. load current and switching frequency at  $T_{P1} = +25\text{ }^\circ\text{C}$ ,  $V_i = 12\text{ V}$ ,  $V_o = 1.0\text{ V}$ ,  $C_o = 470\text{ }\mu\text{F}/10\text{ m}\Omega$   
Default configuration except changed frequency

Load transient vs. Switching frequency

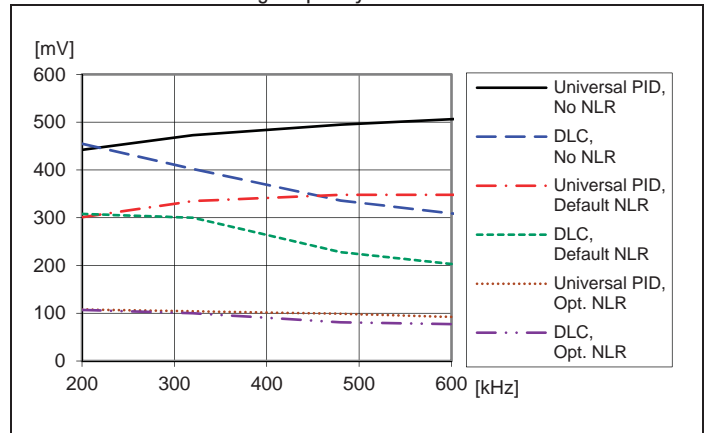

Load transient peak voltage deviation vs. frequency. Step-change (12.5-37.5-12.5 A).  $T_{P1} = +25\text{ }^\circ\text{C}$ ,  $V_i = 12\text{ V}$ ,  $V_o = 1.0\text{ V}$ ,  $C_o = 470\text{ }\mu\text{F}/10\text{ m}\Omega$

Power Dissipation vs. Output Current and Switching frequency

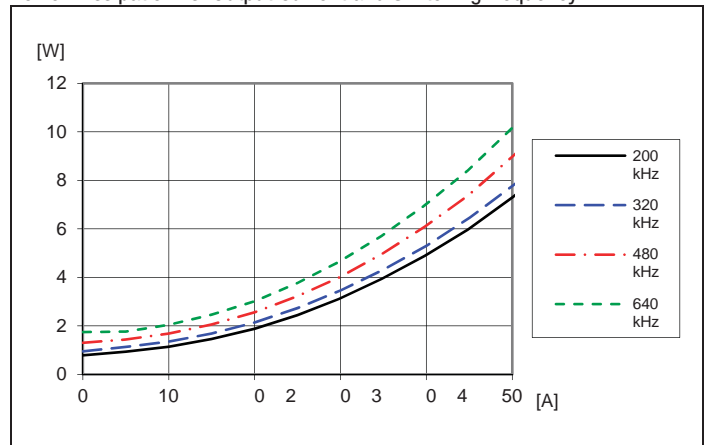

Dissipated power vs. load current and switching frequency at  $T_{P1} = +25\text{ }^\circ\text{C}$ ,  $V_i = 12\text{ V}$ ,  $V_o = 1.0\text{ V}$ ,  $C_o = 470\text{ }\mu\text{F}/10\text{ m}\Omega$   
Default configuration except changed frequency

Output Ripple vs. Switching frequency

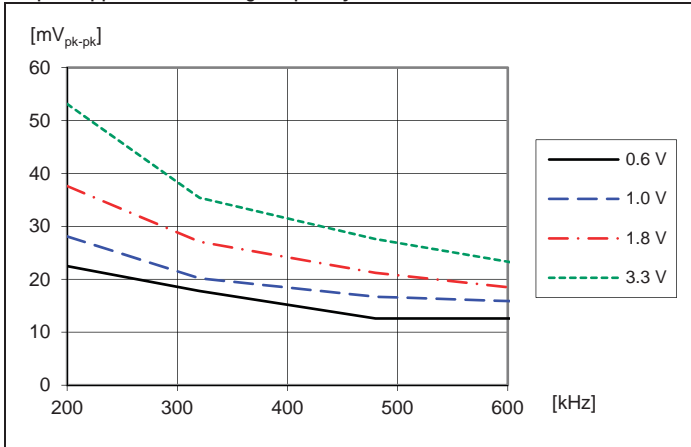

Output voltage ripple  $V_{pk-pk}$  at:  $T_{P1} = +25^\circ\text{C}$ ,  $V_i = 12\text{ V}$ ,  $C_0 = 470\ \mu\text{F}/10\ \text{m}\Omega$ ,  $I_0 = 50\ \text{A}$  resistive load. Default configuration except changed frequency.

Output Load Transient Response, Default Configuration

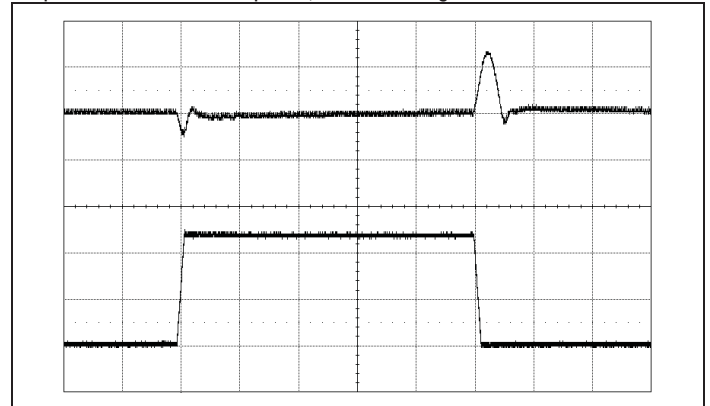

Output voltage response to load current step-change (12.5-37.5-12.5 A) at:  
 $T_{P1} = +25^\circ\text{C}$ ,  $V_i = 12\text{ V}$ ,  $V_0 = 1.0\text{ V}$   
 $di/dt = 2\ \text{A}/\mu\text{s}$ ,  $f_{sw} = 320\ \text{kHz}$ ,  $C_0 = 470\ \mu\text{F}/10\ \text{m}\Omega$   
 Default configuration (DLC and default NLR)  
 Top trace: output voltage (200 mV/div.).  
 Bottom trace: load current (10 A/div.).  
 Time scale: (0.1 ms/div.).

Load Transient vs. Decoupling Capacitance,  $V_0 = 1.0\text{ V}$

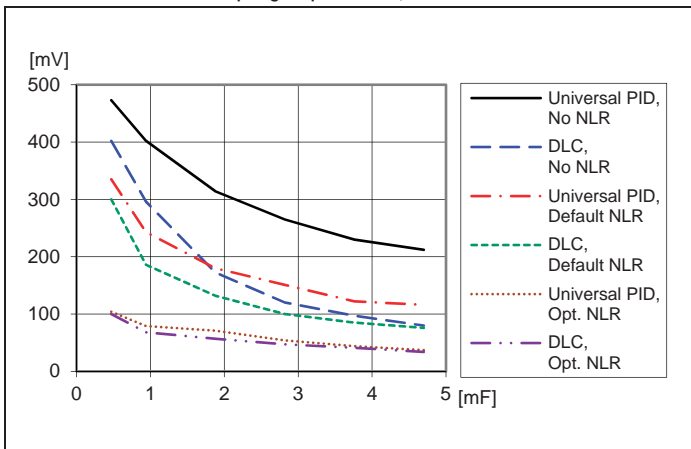

Load transient peak voltage deviation vs. decoupling capacitance. Step (12.5-37.5-12.5 A). Parallel coupling of capacitors with  $470\ \mu\text{F}/10\ \text{m}\Omega$ ,  $T_{P1} = +25^\circ\text{C}$ ,  $V_i = 12\text{ V}$ ,  $V_0 = 1.0\text{ V}$ ,  $f_{sw} = 320\ \text{kHz}$ ,  $di/dt = 2\ \text{A}/\mu\text{s}$

Output Load Transient Response, DLC and No NLR

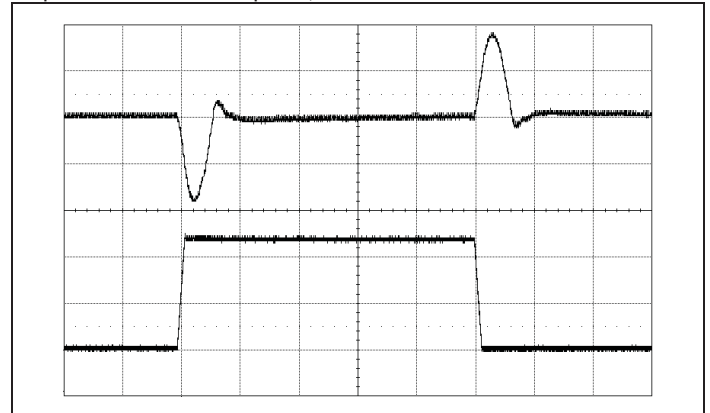

Output voltage response to load current step-change (12.5-37.5-12.5 A) at:  
 $T_{P1} = +25^\circ\text{C}$ ,  $V_i = 12\text{ V}$ ,  $V_0 = 1.0\text{ V}$   
 $di/dt = 2\ \text{A}/\mu\text{s}$ ,  $f_{sw} = 320\ \text{kHz}$ ,  $C_0 = 470\ \mu\text{F}/10\ \text{m}\Omega$   
 DLC and no NLR  
 Top trace: output voltage (200 mV/div.).  
 Bottom trace: load current (10 A/div.).  
 Time scale: (0.1 ms/div.).

Load Transient vs. Decoupling Capacitance,  $V_0 = 3.3\text{ V}$

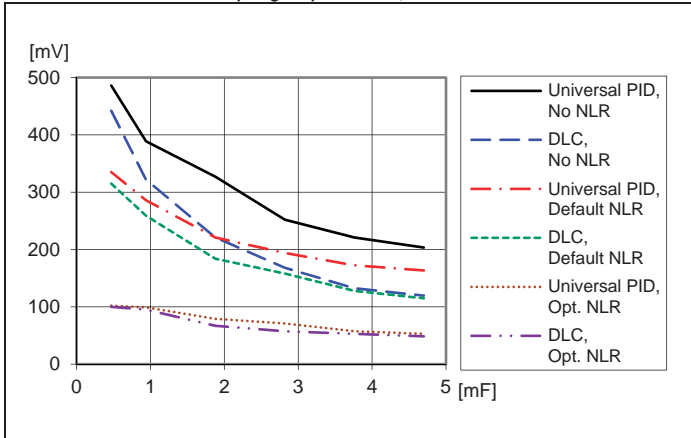

Load transient peak voltage deviation vs. decoupling capacitance. Step (12.5-37.5-12.5 A). Parallel coupling of capacitors with  $470\ \mu\text{F}/10\ \text{m}\Omega$ ,  $T_{P1} = +25^\circ\text{C}$ ,  $V_i = 12\text{ V}$ ,  $V_0 = 3.3\text{ V}$ ,  $f_{sw} = 320\ \text{kHz}$ ,  $di/dt = 2\ \text{A}/\mu\text{s}$

Output Load Transient Response, DLC and Optimized NLR

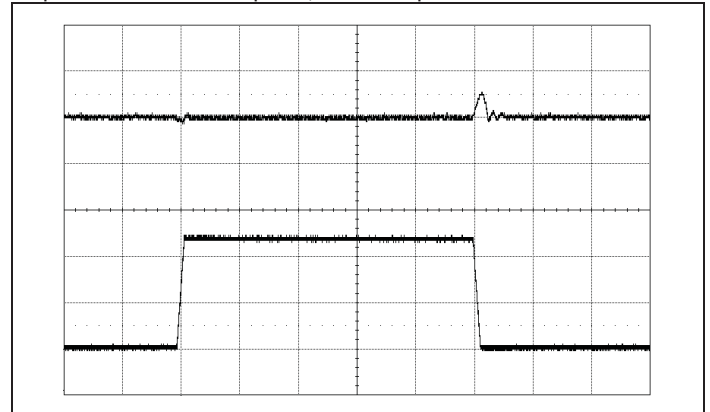

Output voltage response to load current step-change (12.5-37.5-12.5 A) at:  
 $T_{P1} = +25^\circ\text{C}$ ,  $V_i = 12\text{ V}$ ,  $V_0 = 1.0\text{ V}$   
 $di/dt = 2\ \text{A}/\mu\text{s}$ ,  $f_{sw} = 320\ \text{kHz}$ ,  $C_0 = 470\ \mu\text{F}/10\ \text{m}\Omega$   
 DLC and optimized NLR  
 Top trace: output voltage (200 mV/div.).  
 Bottom trace: load current (10 A/div.).  
 Time scale: (0.1 ms/div.).

**Thermal Consideration**

*General*

The product is designed to operate in different thermal environments and sufficient cooling must be provided to ensure reliable operation.

Cooling is achieved mainly by conduction, from the pins to the host board, and convection, which is dependent on the airflow across the product. Increased airflow enhances the cooling of the product.

The Output Current Derating graph found in the Output section for each model provides the available output current vs. ambient air temperature and air velocity at specified VI.

The product is tested on a 254 x 254 mm, 35 μm (1 oz), test board mounted vertically in a wind tunnel with a cross-section of 608 x 203 mm. The test board has 8 layers.

Proper cooling of the product can be verified by measuring the temperature at positions P1 and P2. The temperature at these positions should not exceed the max values provided in the table below.

Note that the max value is the absolute maximum rating (non destruction) and that the electrical Output data is guaranteed up to TP1 +95°C.

**Definition of product operating temperature**

The product operating temperatures are used to monitor the temperature of the product, and proper thermal conditions can be verified by measuring the temperature at positions P1 and P2. The temperature at these positions (TP1, TP2) should not exceed the maximum temperatures in the table below. The number of measurement points may vary with different thermal design and topology. Temperatures above maximum TP1, measured at the reference point P1 are not allowed and may cause permanent damage. It should also be noted that depending on setting of the over temperature protection (OTP) and operating conditions, the product may shut down before the maximum allowed temperature at TP1 is reached.

Position	Description	Max Temp.
P1	Reference point, L1, inductor	125°C*
P2	N1, control circuit	125°C*

\* A guard band of 5 °C is applied to the maximum recorded component temperatures when calculating output current derating curves.

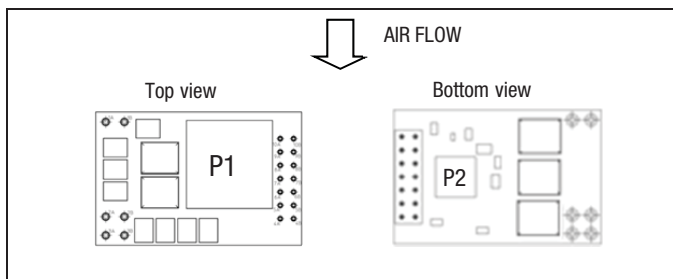

Temperature positions and air flow direction.

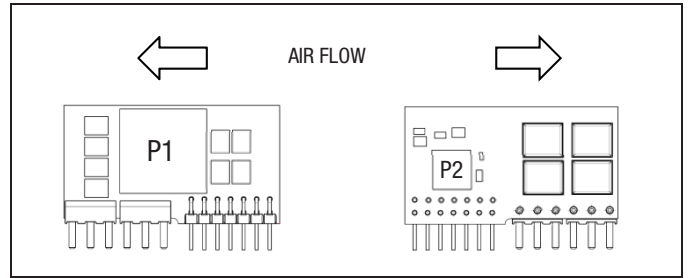

SIP Version: Temperature positions and air flow direction.

**Definition of reference temperature TP1**

The reference temperature is used to monitor the temperature limits of the product. Temperature above maximum TP1, measured at the reference point P1 is not allowed and may cause degradation or permanent damage to the product. TP1 is also used to define the temperature range for normal operating conditions. TP1 is defined by the design and used to guarantee safety margins, proper operation and high reliability of the product.

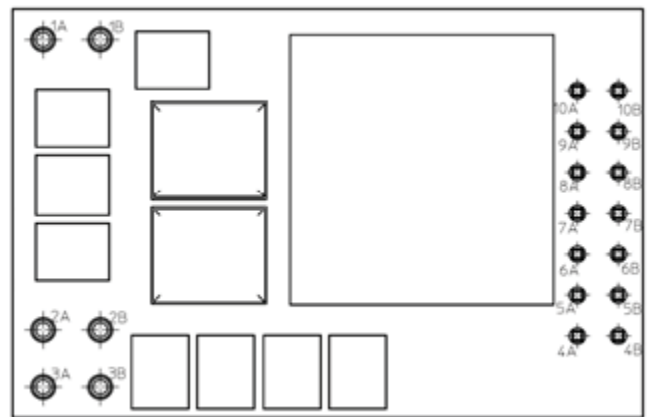

Pin layout, top view (component placement for illustration only).

Pin	Designation	Function
1A, 1B	VIN	Input Voltage
2A, 2B	GND	Power Ground
3A, 3B	VOUT	Output Voltage
4A	VTRK	Voltage Tracking input
4B	PREF	Pin-strap reference
5A	+S	Positive sense
5B	-S	Negative sense
6A	SA0	PMBus address pinstrap 0
6B	GCB	Group Communication Bus
7A	SCL	PMBus Clock
7B	SDA	PMBus Data
8A	VSET	Output voltage pinstrap
8B	SYNC	Synchronization I/O
9A	SALERT	PMBus Alert
9B	CTRL	Remote Control
10A	PG	Power Good
10B	SA1	PMBus address pinstrap 1

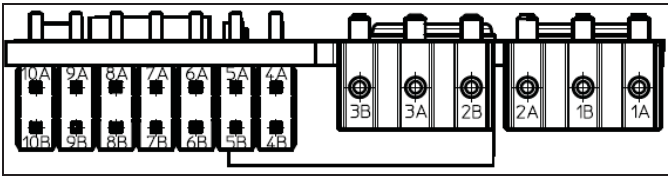

SIP Version: Pin layout, top view (component placement for illustration only).

Pin	Designation	Function
1A, 1B	VIN	Input Voltage
2A, 2B	GND	Power Ground
3A, 3B	VOUT	Output Voltage
4A	+S	Positive sense
4B	-S	Negative sense
5A	VSET	Output voltage pinstrap
5B	VTRK	Voltage Tracking input
6A	SALERT	PMBus Alert
6B	SDA	PMBus Data
7A	SCL	PMBus Clock
7B	SA1	PMBus address pinstrap 1
8A	SA0	PMBus address pinstrap 0
8B	SYNC	Synchronization I/O
9A	PG	Power Good
9B	CTRL	Remote Control
10A	GCB	Group Communication Bus
10B	PREF	Pin-strap reference

**Unused input pins**

Unused SDA, SCL and GCB pins should still have pull-up resistors as specified.

Unused VTRK or SYNC pins should be left open or connected to the PREF pin.

Unused CTRL pin can be left open due to internal pull-up.

VSET and SA0/SA1 pins must be used. These pins must have pin-strap resistors or strapping settings as specified.

**PWB layout considerations**

The pin-strap resistors, RSET, and RSA0/RSA1 should be placed as close to the product as possible to minimize loops that may pick up noise.

Avoid current carrying planes under the pin-strap resistors and the PMBus signals.

The capacitor C<sub>I</sub> (or capacitors implementing it) should be placed as close to the input pins as possible.

Capacitor C<sub>O</sub> (or capacitors implementing it) should be placed close to the load.

Care should be taken in the routing of the connections from the sensed output voltage to the S+ and S- terminals. These sensing connections should be routed as a differential pair, preferably between ground planes which are not carrying high currents. The routing should avoid areas of high electric or magnetic fields.

**Typical Application Circuit**

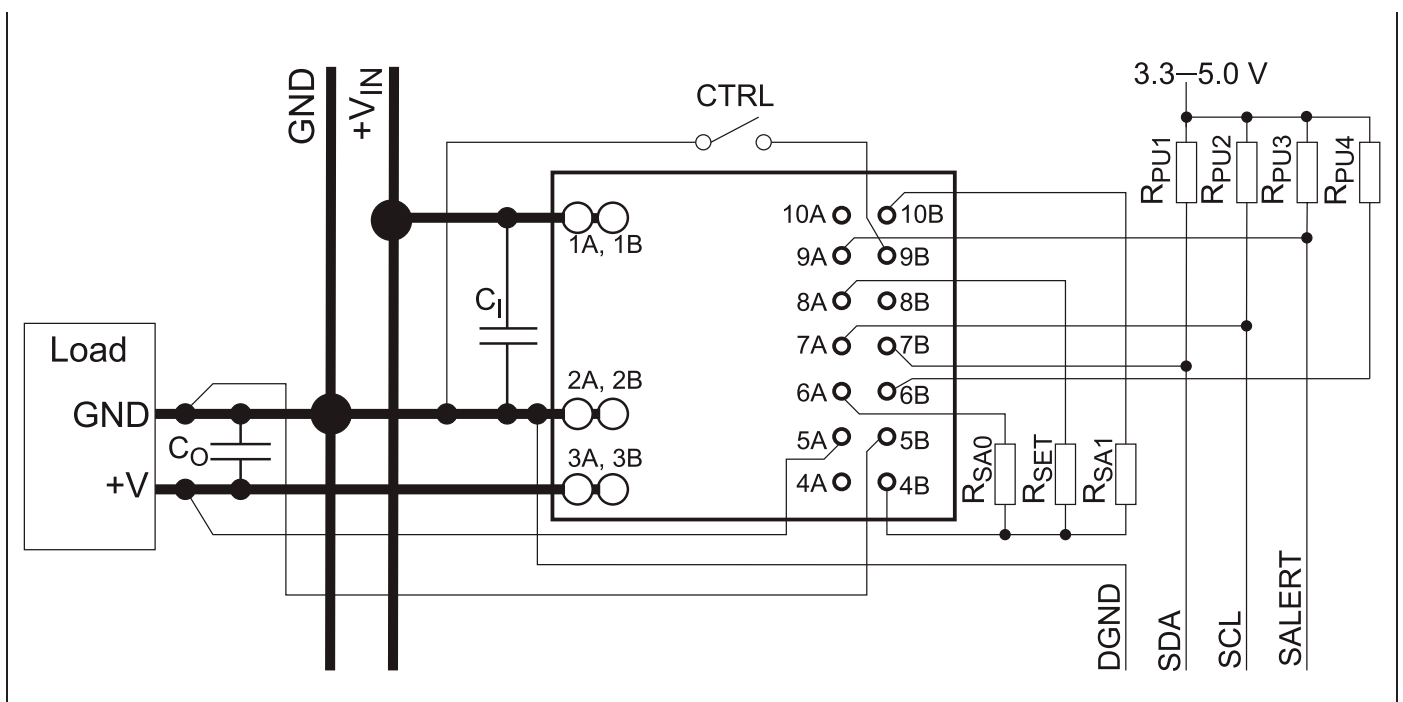

Standalone operation with PMBus communication. Top view of product footprint.

**Typical Application Circuit (SIP version)**

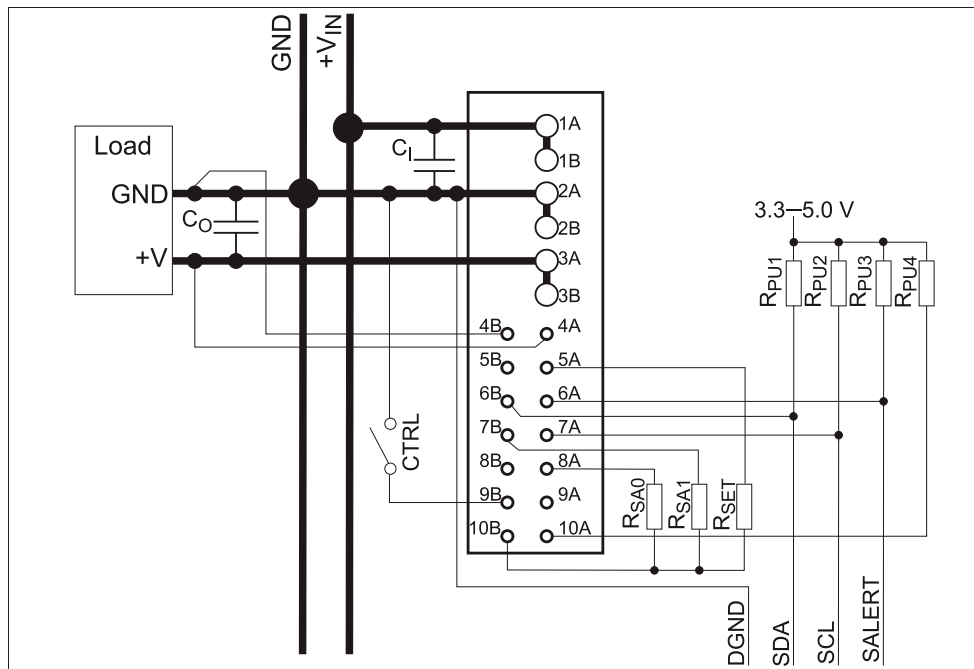

Standalone operation with PMBus communication. Top view of product footprint.

**Typical Application Circuit (Parallel Operation)**

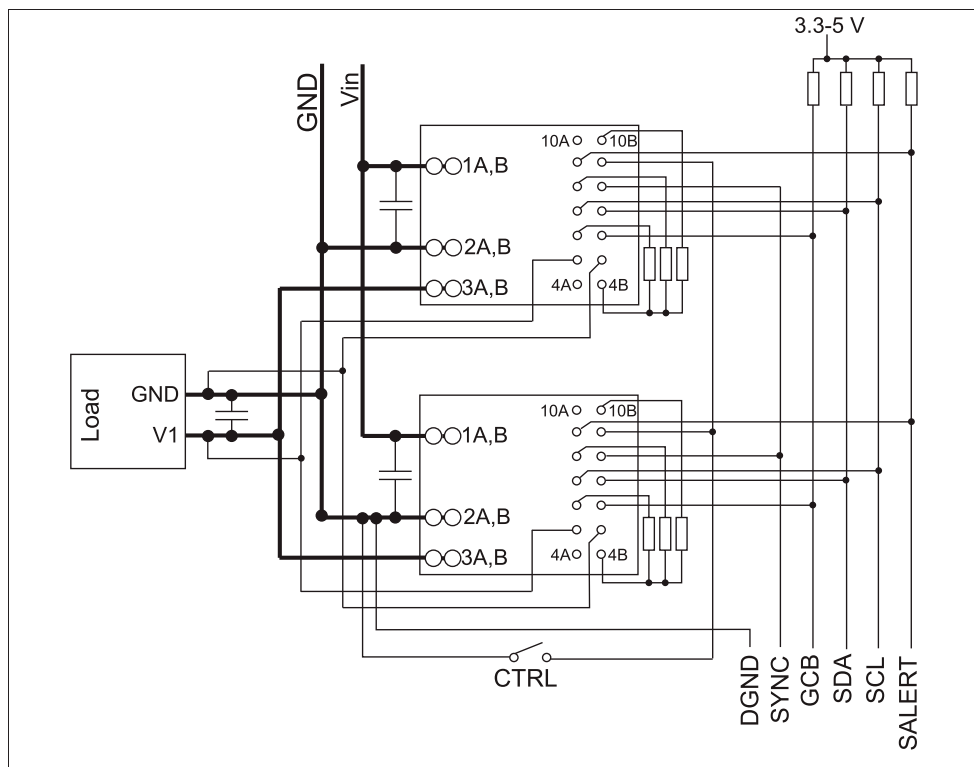

**PMBus interface**

This product provides a PMBus digital interface that enables the user to configure many aspects of the device operation as well as to monitor the input and output voltages, output current and device temperature. The product can be used with any standard two-wire I<sup>2</sup>C or SMBus host device. In addition, the product is compatible with PMBus version 1.1 and includes an SALERT line to help mitigate bandwidth limitations related to continuous fault monitoring. The product supports 100 kHz bus clock frequency only. The PMBus signals, SCL, SDA and SALERT require passive pull-up resistors as stated in the SMBus Specification. Pull-up resistors are required to guarantee the rise time as follows:

$$\text{Eq. 6. } \tau = R_p C_p \leq 1 \mu\text{s,}$$

where  $R_p$  is the pull-up resistor value and  $C_p$  is the bus loading, the maximum allowed bus load is 400 pF. The pull-up resistor should be tied to an external supply voltage in range from 2.7 to 5.5 V, which should be present prior to or during power-up. If the proper power supply is not available, voltage dividers may be applied. Note that in this case, the resistance in the equation above corresponds to parallel connection of the resistors forming the voltage divider.

**Monitoring via PMBus**

It is possible to monitor a wide variety of parameters through the PMBus interface. Fault conditions can be monitored using the SALERT pin, which will be asserted when any number of pre-configured fault or warning conditions occurs. It is also possible to continuously monitor one or more of the power conversion parameters including but not limited to the following:

- Input voltage (READ\_VIN)
- Output voltage (READ\_VOUT)
- Output current (READ\_IOUT)
- Internal junction temperature (READ\_TEMPERATURE\_1)
- Switching frequency (READ\_FREQUENCY)
- Duty cycle (READ\_DUTY\_CYCLE)

In the default configuration monitoring is enabled also when the output voltage is disabled. This can be changed in order to reduce standby power consumption.

**Snap shot parameter capture**

This product offers a special feature that enables the user to capture parametric data during normal operation or following a fault. The following parameters are stored:

- Input voltage
- Output voltage
- Output current
- Internal junction temperature
- Switching frequency
- Duty cycle
- Status registers

The Snapshot feature enables the user to read the parameters via the PMBus interface during normal operation, although it should be noted that reading the 22 bytes will occupy the bus for some time. The Snapshot enables the user to store the snapshot parameters to Flash memory in response to a pending fault as well as to read the stored data from Flash memory after a fault has occurred. Automatic store to Flash memory following a fault is triggered when any fault threshold level is exceeded, provided that the specific fault response is to shut down. Writing to Flash memory is not allowed if the device is configured to restart following the specific fault condition. It should also be noted that the device supply voltage must be maintained during the time the device is writing data to Flash memory; a process that requires between 700-1400  $\mu\text{s}$  depending on whether the data is set up for a block write. Undesirable results may be observed if the input voltage of the product drops below 3.0 V during this process.

**Non-Volatile Memory (NVM)**

The product incorporates two Non-Volatile Memory areas for storage of the supported PMBus commands; the Default NVM and the User NVM.

The Default NVM is pre-loaded with Murata factory default values. The Default NVM is write-protected and can be used to restore the Murata factory default values through the command RESTORE\_DEFAULT\_ALL.

The User NVM is pre-loaded with Murata factory default values. The User NVM is writable and open for customization. The values in NVM are loaded into operational RAM during initialization according to section "Initialization Procedure", where after commands can be changed through the PMBus interface. The STORE\_USER\_ALL command will store the changed parameters to the User NVM.

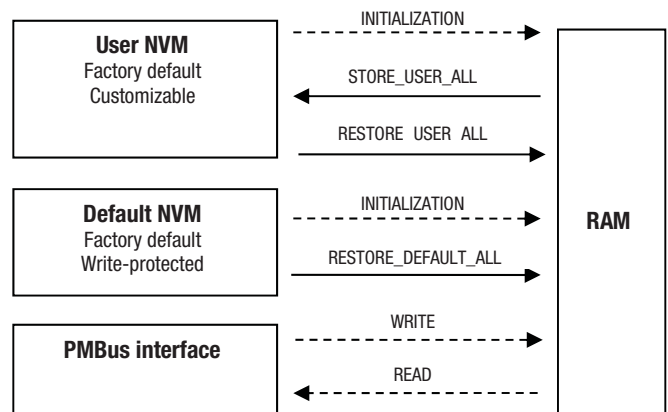

**Software tools for design and production**

Murata provides software tools for configuration and monitoring of this product via the PMBus interface. For more information please contact your local Murata sales representative.

**PMBus addressing**

The PMBus address should be configured with resistors connected between the SA0/SA1 pins and the PREF pin, as shown in the



figure below. Recommended resistor values for hard-wiring PMBus addresses are shown in the table. 1% tolerance resistors are required.

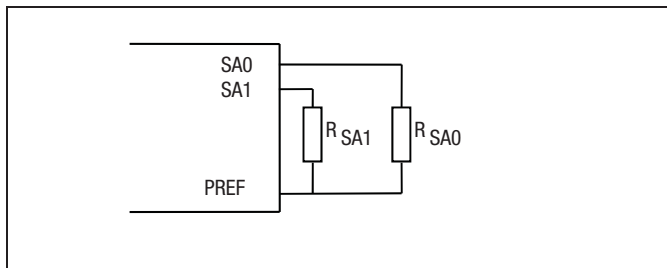

**Schematic of connection of address resistor.**

Index	R <sub>SA</sub> [kΩ]	Index	R <sub>SA</sub> [kΩ]
0	10	13	34.8
1	11	14	38.3
2	12.1	15	42.2
3	13.3	16	46.4
4	14.7	17	51.1
5	16.2	18	56.2
6	17.8	19	61.9
7	19.6	20	68.1
8	21.5	21	75
9	23.7	22	82.5
10	26.1	23	90.9
11	28.7	24	100
12	31.6		

The PMBus address follows the equation below:

Eq. 7. PMBus Address (decimal) = 25 x (SA1 index) + (SA0 index)

The user can theoretically configure up to 625 unique PMBus addresses, however the PMBus address range is inherently limited to 128. Therefore, the user should use index values 0 - 4 on the SA1 pin and the full range of index values on the SA0 pin, which will provide 125 device address combinations. The user shall also be aware of further limitations of the address space as stated in the SMBus Specification.

Note that address 0x4B is allocated for production needs and cannot be used.

**Optional PMBus Addressing**

Alternatively the PMBus address can be defined by connecting the SA0/SA1 pins according to the table below. SA1 = open for products with no SA1 pin.

		SA0		
		low	open	high
SA1	low	20h	21h	22h
	open	23h	24h	25h
	high	26h	27h	Reserved

Low = Shorted to PREF  
Open = High impedance  
High = Logic high, GND as reference,  
Logic High definitions see Electrical Specification

**Reserved Addresses**

Address 4Bh is allocated for production needs and cannot be used.

Addresses listed in the table below are reserved or assigned according to the SMBus specification and may not be usable. Refer to the SMBus specification for further information.

Address (decimal)	Comment
0	General Call Address / START byte
1	CBUS address
2	Address reserved for different bus format
3-7	Reserved for future use
8	SMBus Host
9-11	Assigned for Smart Battery
12	SMBus Alert Response Address
40	Reserved for ACCESS.bus host
44-45	Reserved by previous versions of the SMBus specification
55	Reserved for ACCESS.bus default address
64-68	Reserved by previous versions of the SMBus specification
72-75	Unrestricted addresses
97	SMBus Device Default Address
120-123	10-bit slave addressing
124-127	Reserved for future use

**I<sup>2</sup>C/SMBus – Timing**

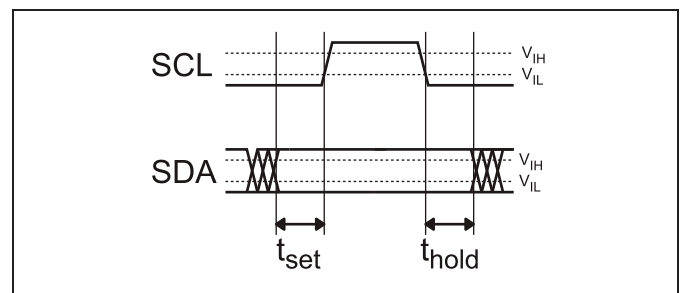

**Setup and hold times timing diagram**

The setup time, t<sub>set</sub>, is the time data, SDA, must be stable before the rising edge of the clock signal, SCL. The hold time t<sub>hold</sub>, is the time data, SDA, must be stable after the rising edge of the clock signal, SCL. If these times are violated incorrect data may be captured or meta-stability may occur and the bus communication may fail. When configuring the product, all standard SMBus protocols must be followed, including clock stretching. Refer to the SMBus specification, for SMBus electrical and timing requirements.

This product does not support the BUSY flag in the status commands to indicate product being too busy for SMBus response. Instead a bus-free time delay according to this specification must occur between every SMBus transmission (between every stop & start condition). In case of storing the RAM content into the internal non-volatile memory (commands STORE\_USER\_ALL and STORE\_DEFAULT\_ALL) an additional delay of 100 ms has to be inserted. A 100 ms delay should be inserted after a restore from internal non-volatile memory (commands RESTORE\_DEFAULT\_ALL and RESTORE\_USER\_ALL).

## PMBus Commands

The products are PMBus compliant. The following table lists the implemented PMBus read commands. For more detailed information see PMBus Power System Management Protocol Specification; Part I – General Requirements, Transport and Electrical Interface and PMBus Power System Management Protocol; Part II – Command Language.

Designation	Cmd	Impl
<b>Standard PMBus Commands</b>		
<b>Control Commands</b>		
PAGE	00h	No
OPERATION	01h	Yes
ON_OFF_CONFIG	02h	Yes
WRITE_PROTECT	10h	No
<b>Output Commands</b>		
VOUT_MODE (Read Only)	20h	Yes
VOUT_COMMAND	21h	Yes
VOUT_TRIM	22h	Yes
VOUT_CAL_OFFSET	23h	Yes
VOUT_MAX	24h	Yes
VOUT_MARGIN_HIGH	25h	Yes
VOUT_MARGIN_LOW	26h	Yes
VOUT_TRANSITION_RATE	27h	Yes
VOUT_DROOP	28h	Yes
MAX_DUTY	32h	Yes
FREQUENCY_SWITCH	33h	Yes
VIN_ON	35h	No
VIN_OFF	36h	No
IOUT_CAL_GAIN	38h	Yes
IOUT_CAL_OFFSET	39h	Yes
VOUT_SCALE_LOOP	29h	No
VOUT_SCALE_MONITOR	2Ah	No
COEFFICIENTS	30h	No
<b>Fault Limit Commands</b>		
POWER_GOOD_ON	5Eh	Yes
POWER_GOOD_OFF	5Fh	No
VOUT_OV_FAULT_LIMIT	40h	Yes
VOUT_OV_WARN_LIMIT	42h	No
VOUT_UV_WARN_LIMIT	43h	No
VOUT_UV_FAULT_LIMIT	44h	Yes
IOUT_OC_FAULT_LIMIT	46h	Yes
IOUT_OC_WARN_LIMIT	4Ah	No
IOUT_UC_FAULT_LIMIT	4Bh	Yes
OT_FAULT_LIMIT	4Fh	Yes
OT_WARN_LIMIT	51h	Yes
UT_WARN_LIMIT	52h	Yes
UT_FAULT_LIMIT	53h	Yes
VIN_OV_FAULT_LIMIT	55h	Yes
VIN_OV_WARN_LIMIT	57h	Yes
VIN_UV_WARN_LIMIT	58h	Yes
VIN_UV_FAULT_LIMIT	59h	Yes
<b>Fault Response Commands</b>		
VOUT_OV_FAULT_RESPONSE	41h	Yes
VOUT_UV_FAULT_RESPONSE	45h	Yes
OT_FAULT_RESPONSE	50h	Yes
UT_FAULT_RESPONSE	54h	Yes
VIN_OV_FAULT_RESPONSE	56h	Yes
VIN_UV_FAULT_RESPONSE	5Ah	Yes
IOUT_OC_FAULT_RESPONSE	47h	No
IOUT_UC_FAULT_RESPONSE	4Ch	No
<b>Time setting Commands</b>		
TON_DELAY	60h	Yes

Designation	Cmd	Impl
TON_RISE	61h	Yes
TOFF_DELAY	64h	Yes
TOFF_FALL	65h	Yes
TON_MAX_FAULT_LIMIT	62h	No
<b>Status Commands (Read Only)</b>		
CLEAR_FAULTS	03h	Yes
STATUS_BYTE	78h	Yes
STATUS_WORD	79h	Yes
STATUS_VOUT	7Ah	Yes
STATUS_IOUT	7Bh	Yes
STATUS_INPUT	7Ch	Yes
STATUS_TEMPERATURE	7Dh	Yes
STATUS_CML	7Eh	Yes
STATUS_MFR_SPECIFIC	80h	Yes
<b>Monitor Commands (Read Only)</b>		
READ_VIN	88h	Yes
READ_VOUT	8Bh	Yes
READ_IOUT	8Ch	Yes
READ_TEMPERATURE_1	8Dh	Yes
READ_TEMPERATURE_2	8Eh	No
READ_FAN_SPEED_1	90h	No
READ_DUTY_CYCLE	94h	Yes
READ_FREQUENCY	95h	Yes
<b>Group Commands</b>		
INTERLEAVE	37h	Yes
PHASE_CONTROL	F0h	Yes
<b>Identification Commands</b>		
PMBUS_REVISION	98h	Yes
MFR_ID	99h	Yes
MFR_MODEL	9Ah	Yes
MFR_REVISION	9Bh	Yes
MFR_LOCATION	9Ch	Yes
MFR_DATE	9Dh	Yes
MFR_SERIAL	9Eh	Yes
<b>Supervisory Commands</b>		
STORE_DEFAULT_ALL	11h	Yes
RESTORE_DEFAULT_ALL	12h	Yes
STORE_USER_ALL	15h	Yes
RESTORE_USER_ALL	16h	Yes
<b>Product Specific Commands</b>		
<b>Output Commands</b>		
XTEMP_SCALE	D9h	No
XTEMP_OFFSET	DAh	No
<b>Time Setting Commands</b>		
POWER_GOOD_DELAY	D4h	Yes
<b>Fault limit Commands</b>		
IOUT_AVG_OC_FAULT_LIMIT	E7h	Yes
IOUT_AVG_UC_FAULT_LIMIT	E8h	Yes
<b>Fault Response Commands</b>		
MFR_IOUT_OC_FAULT_RESPONSE	E5h	Yes
MFR_IOUT_UC_FAULT_RESPONSE	E6h	Yes
OVUV_CONFIG	D8h	Yes
<b>Configuration and Control Commands</b>		
MFR_CONFIG	D0h	Yes
USER_CONFIG	D1h	Yes
MISC_CONFIG	E9h	Yes
TRACK_CONFIG	E1h	Yes
PID_TAPS	D5h	Yes
PID_TAPS_CALC'	F2h	Yes
INDUCTOR	D6h	Yes
NLR_CONFIG	D7h	Yes

Designation	Cmd	Impl
TEMPCO_CONFIG	DCh	Yes
IOUT_OMEGA_OFFSET*	BEh	Yes
AUTO_COMP_CONTROL**	BDh	Yes
AUTO_COMP_CONFIG**	BCh	Yes
DEADTIME	DDh	Yes
DEADTIME_CONFIG	DEh	Yes
DEADTIME_MAX	BFh	Yes
SNAPSHOT	EAh	Yes
SNAPSHOT_CONTROL	F3h	Yes
DEVICE_ID	E4h	Yes
USER_DATA_00	B0h	Yes
<b>Group Commands</b>		
SEQUENCE	E0h	Yes
GCB_CONFIG	D3h	Yes
GCB_GROUP	E2h	Yes
ISHARE_CONFIG	D2h	Yes
PHASE_CONTROL	F0h	Yes
<b>Supervisory Commands</b>		
PRIVATE_PASSWORD	FBh	Yes
PUBLIC_PASSWORD	FCh	Yes
UNPROTECT	FDh	Yes
SECURITY_LEVEL	FAh	Yes

**Notes:**

Cmd is short for Command.

Impl is short for Implemented.

\* These commands are available in products without DLC.

\*\* These commands are available in products with DLC.

**MECHANICAL SPECIFICATIONS-THROUGH-HOLE MOUNT**

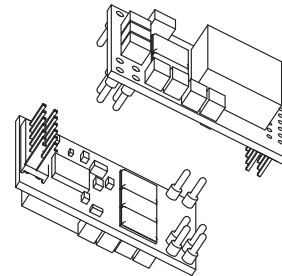
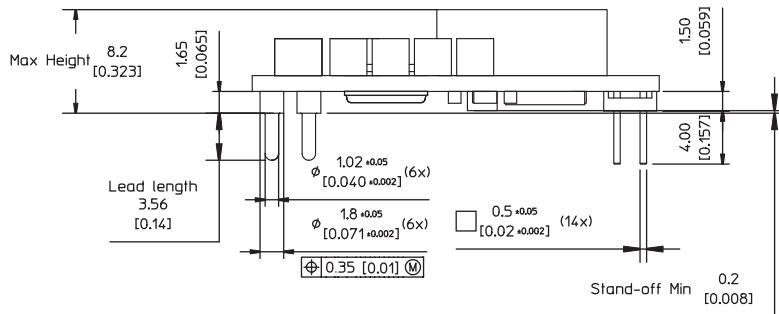

**PIN SPECIFICATIONS**  
 PIN 1A-3B Material: Copper alloy  
 Plating: Min Matte tin 8-13 μm over 2.5-5 μm Ni.  
 PIN 4A-9B Material: Brass  
 Plating: Min Au 0.2 μm over 1.27 μm Ni.

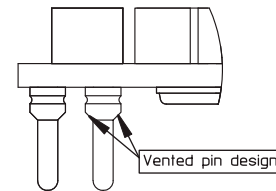
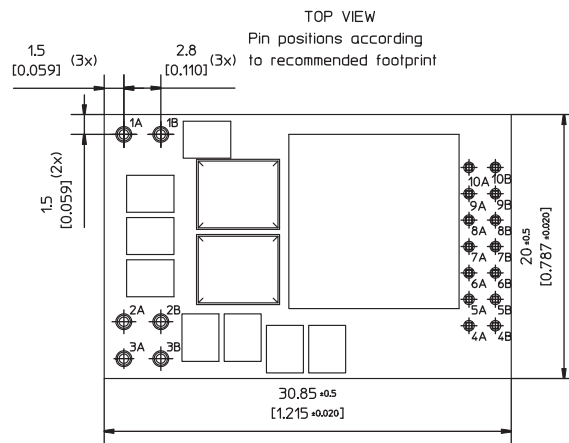

**NOTE:** Vented pin and Au plating  
 Material: CuTe (C14500)  
 Plating: min 0.1 μm Au over 1-3 μm Ni.

RECOMMENDED FOOTPRINT - TOP VIEW

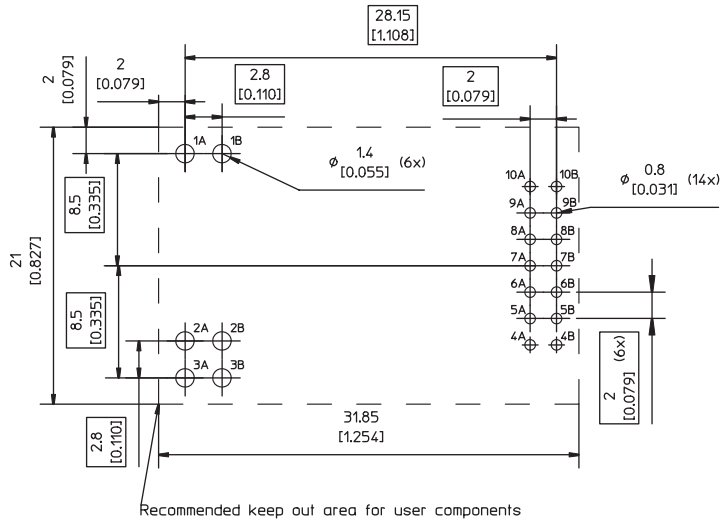

Weight: Typical 10 g  
 All dimensions in mm [inch]  
 Tolerances unless specified  
 x.x ±0.50 [0.02]  
 x.xx ±0.25 [0.01]  
 (not applied on footprint or typical values)



All component placements – whether shown as physical components or symbolical outline – are for reference only and are subject to change throughout the product's life cycle, unless explicitly described and dimensioned in this drawing.

**MECHANICAL SPECIFICATIONS-SURFACE MOUNT**

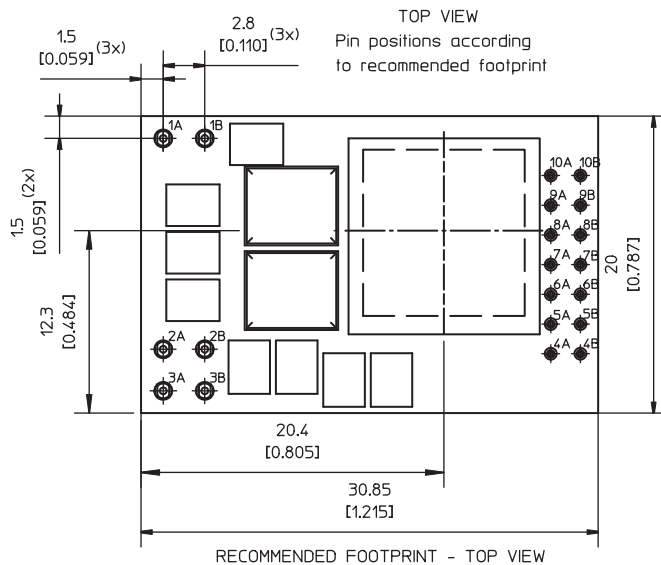
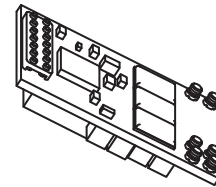
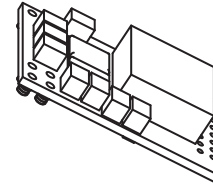
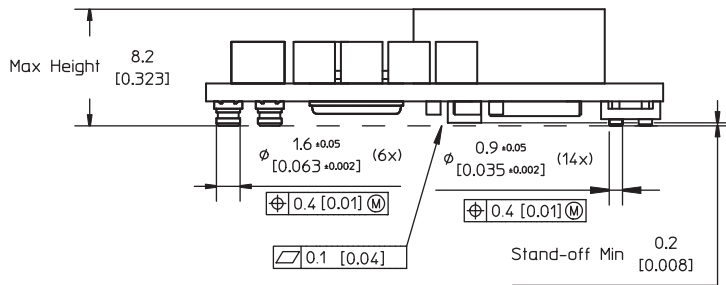

**PIN SPECIFICATIONS**

PIN 1A-3B Material: Copper alloy  
Plating: Min Au 0.1 μm over 1-3 μm Ni.  
PIN 4A-9B Material: Brass  
Plating: Min Au 0.1 μm over 2 μm Ni.

**PICK-UP SURFACE**

Recommended pick-up nozzle size for assigned pick-up area is maximum Ø8 [0.315].

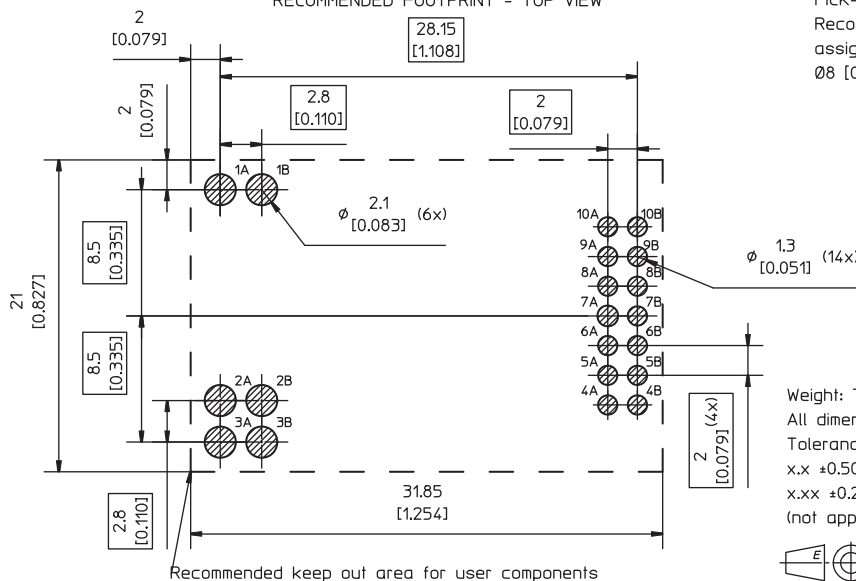

Weight: Typical 9.5 g  
All dimensions in mm [inch]  
Tolerances unless specified:  
x.x ±0.50 [0.02]  
x.xx ±0.25 [0.01]  
(not applied on footprint or typical values)



All component placements – whether shown as physical components or symbolical outline – are for reference only and are subject to change throughout the product's life cycle, unless explicitly described and dimensioned in this drawing.

**MECHANICAL SPECIFICATIONS-SIP VERSION**

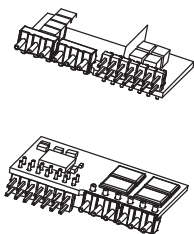

**BOTTOM VIEW**  
Pin positions according to recommended footprint

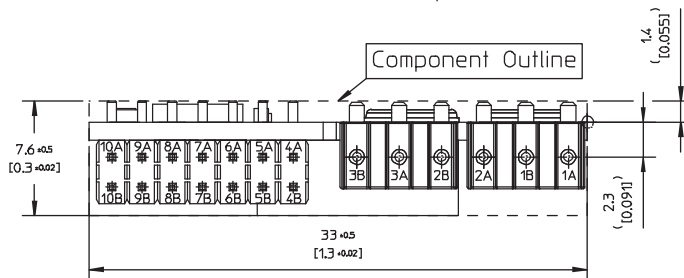

**FRONT VIEW**

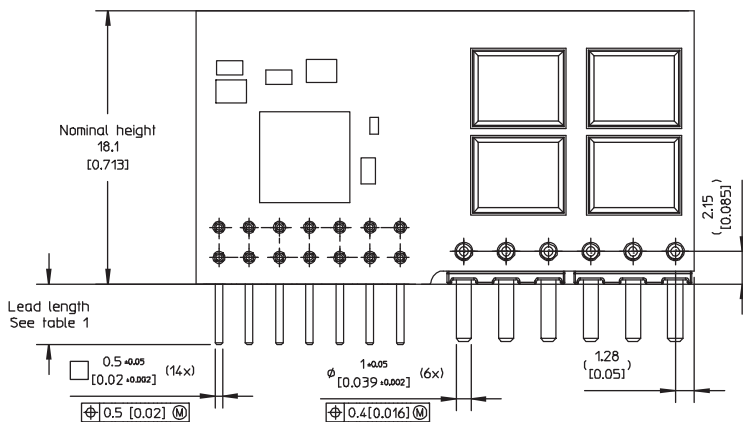
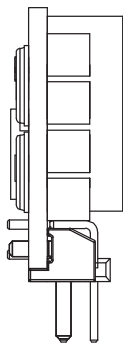
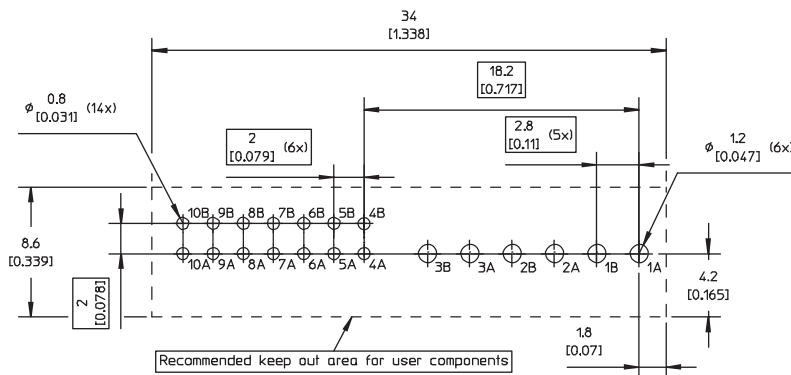

Table 1

Pin option	Lead Length
Standard	4±0.25 [0.157±0.01]

**RECOMMENDED FOOTPRINT - TOP VIEW**



**PIN SPECIFICATIONS**

Pin 1A-3B Material: Copper alloy (C11000)  
Plating: Min Au 0.1 μm over 1-3 μm Ni.  
Pin 4A-10B Material: Copper alloy  
Plating: Min Au 0.1 μm over 1 μm Ni.

Weight: Typical 10.3 g  
All dimensions in mm [inch]  
Tolerances unless specified:  
x.x ±0.50 [0.02]  
x.xx±0.25 [0.01]  
(not applied on footprint or typical values)



All component placements – whether shown as physical components or symbolical outline – are for reference only and are subject to change throughout the product's life cycle, unless explicitly described and dimensioned in this drawing.

**Soldering Information - Surface Mounting and Hole Mount through Pin in Paste Assembly**

The product is intended for forced convection or vapor phase reflow soldering in SnPb or Pb-free processes.

The reflow profile should be optimised to avoid excessive heating of the product. It is recommended to have a sufficiently extended preheat time to ensure an even temperature across the host PWB and it is also recommended to minimize the time in reflow.

A no-clean flux is recommended to avoid entrapment of cleaning fluids in cavities inside the product or between the product and the host board, since cleaning residues may affect long time reliability and isolation voltage.

General reflow process specifications		SnPb eutectic	Pb-free
Average ramp-up ( $T_{PRODUCT}$ )		3°C/s max	3°C/s max
Typical solder melting (liquidus) temperature	$T_L$	183°C	221°C
Minimum reflow time above $T_L$		60 s	60 s
Minimum pin temperature	$T_{PIN}$	210°C	235°C
Peak product temperature	$T_{PRODUCT}$	225°C	260°C
Average ramp-down ( $T_{PRODUCT}$ )		6°C/s max	6°C/s max
Maximum time 25°C to peak		6 minutes	8 minutes

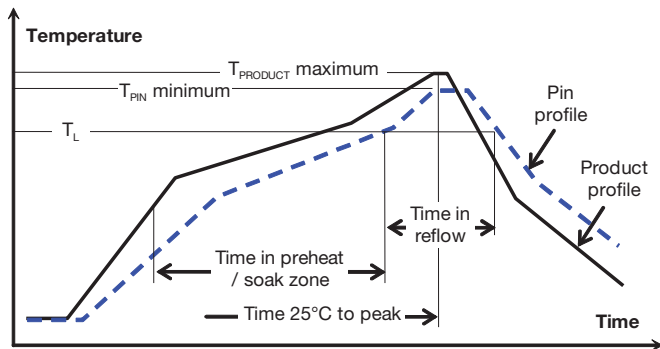

**Minimum Pin Temperature Recommendations**

Pin number 2B is chosen as reference location for the minimum pin temperature recommendation since this will likely be the coolest solder joint during the reflow process.

**SnPb solder processes**

For SnPb solder processes, a pin temperature ( $T_{PIN}$ ) in excess of the solder melting temperature, ( $T_L$ , 183°C for Sn63Pb37) for more than 60 seconds and a peak temperature of 220°C is recommended to ensure a reliable solder joint.

For dry packed products only: depending on the type of solder paste and flux system used on the host board, up to a recommended maximum temperature of 245°C could be used, if the products are kept in a controlled environment (dry pack handling and storage) prior to assembly.

**Lead-free (Pb-free) solder processes**

For Pb-free solder processes, a pin temperature ( $T_{PIN}$ ) in excess of the solder melting temperature ( $T_L$ , 217 to 221°C for SnAgCu solder alloys) for more than 60 seconds and a peak temperature of 245°C on all solder joints is recommended to ensure a reliable solder joint.

**Maximum Product Temperature Requirements**

Top of the product PWB near pin 10B is chosen as reference location for the maximum (peak) allowed product temperature ( $T_{PRODUCT}$ ) since this will likely be the warmest part of the product during the reflow process.

**SnPb solder processes**

For SnPb solder processes, the product is qualified for MSL 1 according to IPC/JEDEC standard J STD 020C.

During reflow  $T_{PRODUCT}$  must not exceed 225 °C at any time.

**Pb-free solder processes**

For Pb-free solder processes, the product is qualified for MSL 3 according to IPC/JEDEC standard J-STD-020C.

During reflow  $T_{PRODUCT}$  must not exceed 260 °C at any time.

**Dry Pack Information**

Products intended for Pb-free reflow soldering processes are delivered in standard moisture barrier bags according to IPC/JEDEC standard J STD 033 (Handling, packing, shipping and use of moisture/reflow sensitivity surface mount devices).

Using products in high temperature Pb-free soldering processes requires dry pack storage and handling. In case the products have been stored in an uncontrolled environment and no longer can be considered dry, the modules must be baked according to J STD 033.

**Thermocoupler Attachment**

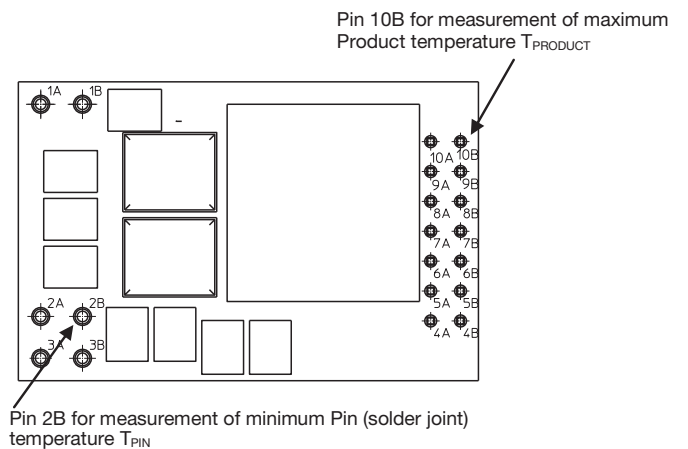

**Soldering Information - Hole Mounting**

The hole mounted product is intended for plated through hole mounting by wave or manual soldering. The pin temperature is specified to maximum to 270°C for maximum 10 seconds.

A maximum preheat rate of 4°C/s and maximum preheat temperature of 150°C is suggested. When soldering by hand, care should be taken to avoid direct contact between the hot soldering iron tip and the pins for more than a few seconds in order to prevent overheating.

A no-clean flux is recommended to avoid entrapment of cleaning fluids in cavities inside the product or between the product and the host board. The cleaning residues may affect long time reliability and isolation voltage.

**Delivery Package Information**

The products are delivered in antistatic carrier tape (EIA 481 standard).

Carrier Tape Specifications	
Material	Antistatic PS
Surface resistance	<10 <sup>7</sup> Ohm/square
Bakeability	The tape is not bakable
Tape width, W	56 mm [2.20 inch]
Pocket pitch, P <sub>i</sub>	32 mm [1.26 inch]
Pocket depth, K <sub>0</sub>	13 mm [0.51 inch]
Reel diameter	381 mm [15 inch]
Reel capacity	130 products /reel
Reel weight	1.8 kg/full reel

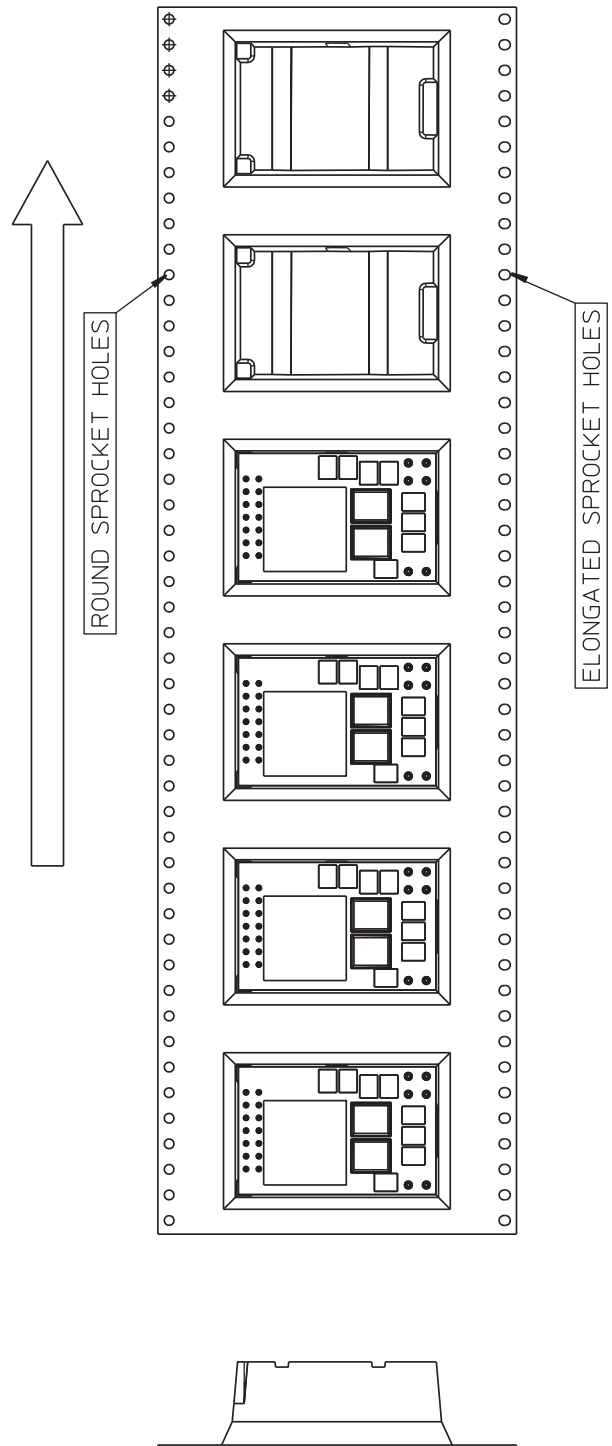



**Soldering Information - Hole Mounting (SIP version)**

The product is intended for plated through hole mounting by wave or manual soldering. The pin temperature is specified to maximum to 270°C for maximum 10 seconds.

A maximum preheat rate of 4°C/s and maximum preheat temperature of 150°C is suggested. When soldering by hand, care should be taken to avoid direct contact between the hot soldering iron tip and the pins for more than a few seconds in order to prevent overheating.

A no-clean flux is recommended to avoid entrapment of cleaning fluids in cavities inside the product or between the product and the host board. The cleaning residues may affect long time reliability and isolation voltage.

**Delivery Package Information (SIP version)**

The products are delivered in antistatic trays.

Tray Specifications	
Material	Antistatic Polyethylene foam
Surface resistance	10 <sup>5</sup> < Ohms/square <10 <sup>11</sup>
Bakability	The trays are not bakeable
Tray thickness	15 mm [0.709 inch]
Box capacity	100 products, 2 full trays/box)
Tray weight	35 g empty tray, 549 g full tray

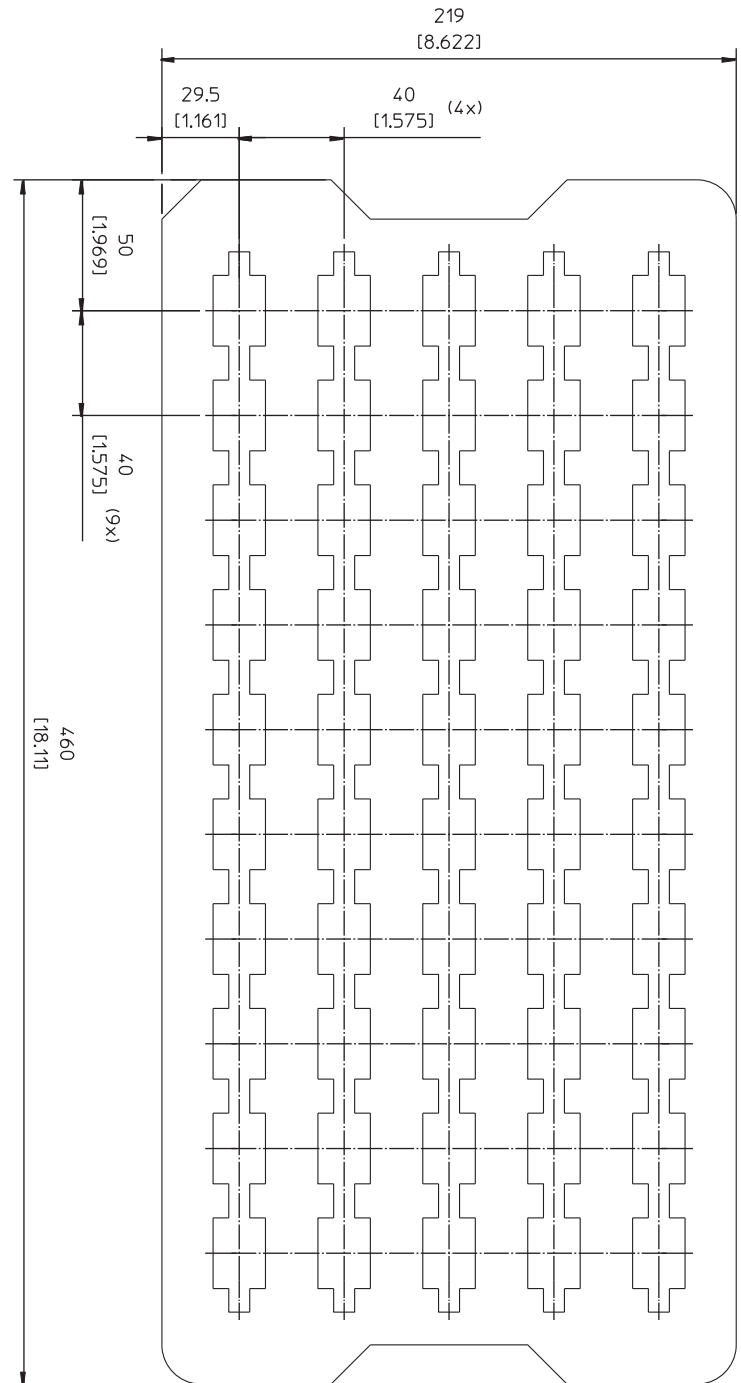

Murata Power Solutions, Inc.  
11 Cabot Boulevard, Mansfield, MA 02048-1151 U.S.A.  
ISO 9001 and 14001 REGISTERED



**This product is subject to the following operating requirements and the Life and Safety Critical Application Sales Policy:**  
Refer to: <http://www.murata-ps.com/requirements/>

Murata Power Solutions, Inc. makes no representation that the use of its products in the circuits described herein, or the use of other technical information contained herein, will not infringe upon existing or future patent rights. The descriptions contained herein do not imply the granting of licenses to make, use, or sell equipment constructed in accordance therewith. Specifications are subject to change without notice. © 2017 Murata Power Solutions, Inc.

## X-ON Electronics

Largest Supplier of Electrical and Electronic Components

*Click to view similar products for [Non-Isolated DC/DC Converters](#) category:*

*Click to view products by [Murata](#) manufacturer:*

Other Similar products are found below :

[BRFS50](#) [APTH003A0X-SRZ](#) [SPM1004-3V3C](#) [R-785.0-05](#) [BRFS30](#) [PJT020A0X43-SRZ](#) [10E24-P15-10PPM](#) [1E24-P4-25PPM-SHV-5KV](#)  
[CA-17205-L4](#) [4D15-N1](#) [MYGTM01210BZN](#) [APXW012A0X3-SRDZ](#) [I6A24008A033V-N00-R](#) [10C24-N250-I10-AQ-DA](#) [4AA24-P20-M-H](#)  
[DX150N](#) [3V12-N0.8](#) [2HVA24-BP1-F-25PPM-SHV-5KV](#) [5HVA24-BP1-F-25PPM-SHV-5KV](#) [1/2AA24-P30-I10](#) [1C24-P20-M-C](#) [VI-](#)  
[920194B](#) [T31SN24005NMFA](#) [3V24-P1](#) [3V24-N1](#) [BMR4672010/001](#) [BMR4652010/001](#) [BMR4668004/001](#) [T31SN12008NMFA](#) [6AA24-](#)  
[P30-I5-M](#) [6AA24-N30-I5-M](#) [PTV03020WAH](#) [PTV05020WAH](#) [PTV12010LAH](#) [PTV12020WAD](#) [R-625.0D](#) [R-7212D](#) [R-7212P](#) [R-745.0D](#)  
[R-78AA15-0.5SMD](#) [R-78AA5.0-1.0SMD](#) [30A24-N15-E](#) [10A12-P4-M](#) [10C24-N250-I5](#) [10C24-P125](#) [10C24-P250-I5](#) [6A24-P20-I10-F-M-](#)  
[25PPM](#) [1A24-P30-F-M-C](#) [TSR 1-24150SM](#) [1/2AA24-N30-I10](#)