

Reference Specification

Leaded MLCC for Automotive with AEC-Q200
RCE Series

Product specifications in this catalog are as of Mar. 2022, and are subject to change or obsolescence without notice.
Please consult the approval sheet before ordering. Please read rating and Cautions first.

⚠ CAUTION**1. OPERATING VOLTAGE**

When DC-rated capacitors are to be used in AC or ripple current circuits, be sure to maintain the V_{p-p} value of the applied voltage or the V_{o-p} which contains DC bias within the rated voltage range. When the voltage is started to apply to the circuit or it is stopped applying, the irregular voltage may be generated for a transit period because of resonance or switching. Be sure to use a capacitor within rated voltage containing these irregular voltage.

When DC-rated capacitors are to be used in input circuits from commercial power source (AC filter), be sure to use Safety Recognized Capacitors because various regulations on withstand voltage or impulse withstand established for each equipment should be taken into considerations.

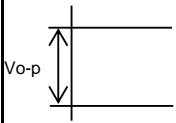
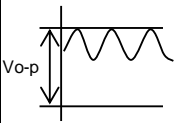
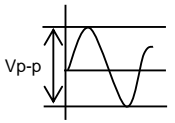
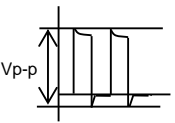
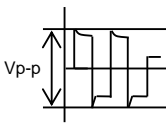
Voltage	DC Voltage	DC+AC Voltage	AC Voltage	Pulse Voltage(1)	Pulse Voltage(2)
Positional Measurement					

2. OPERATING TEMPERATURE AND SELF-GENERATED HEAT

Keep the surface temperature of a capacitor below the upper limit of its rated operating temperature range. Be sure to take into account the heat generated by the capacitor itself.

When the capacitor is used in a high-frequency current, pulse current or the like, it may have the self-generated heat due to dielectric-loss. In case of Class 2 capacitors (Temp.Char. : X7R, X7S, X8L, etc.), applied voltage should be the load such as self-generated heat is within 20 °C on the condition of atmosphere temperature 25 °C. Please contact us if self-generated heat is occurred with Class 1 capacitors (Temp.Char. : C0G, U2J, X8G, etc.). When measuring, use a thermocouple of small thermal capacity-K of $\Phi 0.1\text{mm}$ and be in the condition where capacitor is not affected by radiant heat of other components and wind of surroundings. Excessive heat may lead to deterioration of the capacitor's characteristics and reliability.

3. FAIL-SAFE

Be sure to provide an appropriate fail-safe function on your product to prevent a second damage that may be caused by the abnormal function or the failure of our product.

4. OPERATING AND STORAGE ENVIRONMENT

The insulating coating of capacitors does not form a perfect seal; therefore, do not use or store capacitors in a corrosive atmosphere, especially where chloride gas, sulfide gas, acid, alkali, salt or the like are present. And avoid exposure to moisture. Before cleaning, bonding, or molding this product, verify that these processes do not affect product quality by testing the performance of a cleaned, bonded or molded product in the intended equipment. Store the capacitors where the temperature and relative humidity do not exceed 5 to 40 °C and 20 to 70%. Use capacitors within 6 months.

5. VIBRATION AND IMPACT

Do not expose a capacitor or its leads to excessive shock or vibration during use.

6. SOLDERING

When soldering this product to a PCB/PWB, do not exceed the solder heat resistance specification of the capacitor. Subjecting this product to excessive heating could melt the internal junction solder and may result in thermal shocks that can crack the ceramic element.

7. BONDING AND RESIN MOLDING, RESIN COAT

In case of bonding, molding or coating this product, verify that these processes do not affect the quality of capacitor by testing the performance of a bonded or molded product in the intended equipment.

In case of the amount of applications, dryness / hardening conditions of adhesives and molding resins containing organic solvents (ethyl acetate, methyl ethyl ketone, toluene, etc.) are unsuitable, the outer coating resin of a capacitor is damaged by the organic solvents and it may result, worst case, in a short circuit.

The variation in thickness of adhesive or molding resin may cause a outer coating resin cracking and/or ceramic element cracking of a capacitor in a temperature cycling.

8. TREATMENT AFTER BONDING AND RESIN MOLDING, RESIN COAT

When the outer coating is hot (over 100 °C) after soldering, it becomes soft and fragile.

So please be careful not to give it mechanical stress.

Failure to follow the above cautions may result, worst case, in a short circuit and cause fuming or partial dispersion when the product is used.

9. LIMITATION OF APPLICATIONS

Please contact us before using our products for the applications listed below which require especially high reliability for the prevention of defects which might directly cause damage to the third party's life, body or property.

1. Aircraft equipment
2. Aerospace equipment
3. Undersea equipment
4. Power plant control equipment
5. Medical equipment
6. Transportation equipment (vehicles, trains, ships, etc.)
7. Traffic signal equipment
8. Disaster prevention / crime prevention equipment
9. Data-processing equipment exerting influence on public
10. Application of similar complexity and/or reliability requirements to the applications listed in the above.

NOTICE

1. CLEANING (ULTRASONIC CLEANING)

To perform ultrasonic cleaning, observe the following conditions.

Rinse bath capacity : Output of 20 watts per liter or less.

Rinsing time : 5 min maximum.

Do not vibrate the PCB/PWB directly.

Excessive ultrasonic cleaning may lead to fatigue destruction of the lead wires.

2. SOLDERING AND MOUNTING

Insertion of the Lead Wire

- When soldering, insert the lead wire into the PCB without mechanically stressing the lead wire.
- Insert the lead wire into the PCB with a distance appropriate to the lead space.

3. CAPACITANCE CHANGE OF CAPACITORS

- Class 2 capacitors (Temp.Char. : X7R,X7S,X8L etc.)

Class 2 capacitors an aging characteristic, whereby the capacitor continually decreases its capacitance slightly if the capacitor leaves for a long time. Moreover, capacitance might change greatly depending on a surrounding temperature or an applied voltage. So, it is not likely to be able to use for the time constant circuit.

Please contact us if you need a detail information.

NOTE

1. Please make sure that your product has been evaluated in view of your specifications with our product being mounted to your product.
2. You are requested not to use our product deviating from this specification.

Reference only

1. Application

This specification is applied to Leaded MLCC RCE series in accordance with AEC-Q200 requirements used for Automotive Electronic equipment.

2. Rating

• Part Number Configuration

ex.)

RCE	5C	1H	1R0	C	0	A2	H03	B
Series	Temperature Characteristics	Rated Voltage	Capacitance	Capacitance Tolerance	Dimension (LxW)	Lead Style	Individual Specification	Package

• Temperature Characteristics

Code	Temp. Char.	Temp. Range	Temp.coef.	Standard Temp.	Operating Temp. Range
5C	C0G (EIA code)	-55~25°C	0+30/-72ppm/°C	25°C	-55~125°C
		25~125°C	0+/-30ppm/°C		

• Rated Voltage

Code	Rated voltage
1H	DC50V
2A	DC100V

• Capacitance

The first two digits denote significant figures ; the last digit denotes the multiplier of 10 in pF. If there is a decimal point, it is expressed by the capital letter "R". In this case, all figures are significant digits.

ex.) In case of 102.

$$10 \times 10^2 = 1000\text{pF}$$

In case of 5R0.

$$5.0\text{pF}$$

• Capacitance Tolerance

Code	Capacitance Tolerance
C	+/-0.25pF
D	+/-0.5pF
J	+/-5%

• Dimension (LxW)

Please refer to [Part number list].

• Lead Style

*Lead wire is "solder coated CP wire".

Code	Lead Style	Lead spacing (mm)
A2	Straight type	2.5+/-0.8
DB	Straight taping type	2.5+0.4/-0.2
K1	Inside crimp type	5.0+/-0.8
M1	Inside crimp taping type	5.0+0.6/-0.2

• Individual Specification

Murata's control code.

Please refer to [Part number list].



• Package

Code	Package
A	Taping type of Ammo
B	Bulk type

3. Marking

- Temp. char. : Letter code : A (C0G Char.)
 Capacitance : Actual numbers (Less than 100pF)
 3 digit numbers (100pF and over)
 Capacitance tolerance : Code
 Rated voltage : Letter code : 5 (DC50V. Except dimension code : 0,1)
 Letter code : 1 (DC100V. Except dimension code : 0,1)
 Company name code : Abbreviation :  (Except dimension code : 0,1)

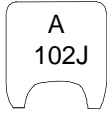
(Ex.)

Rated voltage Dimension code	DC50V	DC100V
	0,1	
2		

4. Part number list

• Straight Long
(Lead Style:A2)

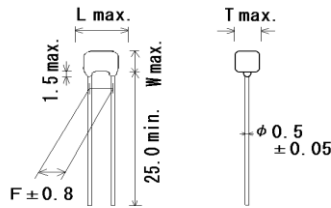

Unit : mm

Customer Part Number	Murata Part Number	T.C.	DC Rated Volt. (V)	Cap.	Cap. Tol.	Dimension (mm)					Dimension (LxW) Lead Style	Pack qty. (pcs)
						L	W	W1	F	T		
	RCE5C1H1R0C0A2H03B	C0G	50	1pF	±0.25pF	3.6	3.5	-	2.5	2.5	0A2	500
	RCE5C1H2R0C0A2H03B	C0G	50	2pF	±0.25pF	3.6	3.5	-	2.5	2.5	0A2	500
	RCE5C1H3R0C0A2H03B	C0G	50	3pF	±0.25pF	3.6	3.5	-	2.5	2.5	0A2	500
	RCE5C1H4R0C0A2H03B	C0G	50	4pF	±0.25pF	3.6	3.5	-	2.5	2.5	0A2	500
	RCE5C1H5R0C0A2H03B	C0G	50	5pF	±0.25pF	3.6	3.5	-	2.5	2.5	0A2	500
	RCE5C1H6R0D0A2H03B	C0G	50	6pF	±0.5pF	3.6	3.5	-	2.5	2.5	0A2	500
	RCE5C1H7R0D0A2H03B	C0G	50	7pF	±0.5pF	3.6	3.5	-	2.5	2.5	0A2	500
	RCE5C1H8R0D0A2H03B	C0G	50	8pF	±0.5pF	3.6	3.5	-	2.5	2.5	0A2	500
	RCE5C1H9R0D0A2H03B	C0G	50	9pF	±0.5pF	3.6	3.5	-	2.5	2.5	0A2	500
	RCE5C1H100J0A2H03B	C0G	50	10pF	±5%	3.6	3.5	-	2.5	2.5	0A2	500
	RCE5C1H120J0A2H03B	C0G	50	12pF	±5%	3.6	3.5	-	2.5	2.5	0A2	500
	RCE5C1H150J0A2H03B	C0G	50	15pF	±5%	3.6	3.5	-	2.5	2.5	0A2	500
	RCE5C1H180J0A2H03B	C0G	50	18pF	±5%	3.6	3.5	-	2.5	2.5	0A2	500
	RCE5C1H220J0A2H03B	C0G	50	22pF	±5%	3.6	3.5	-	2.5	2.5	0A2	500
	RCE5C1H270J0A2H03B	C0G	50	27pF	±5%	3.6	3.5	-	2.5	2.5	0A2	500
	RCE5C1H330J0A2H03B	C0G	50	33pF	±5%	3.6	3.5	-	2.5	2.5	0A2	500
	RCE5C1H390J0A2H03B	C0G	50	39pF	±5%	3.6	3.5	-	2.5	2.5	0A2	500
	RCE5C1H470J0A2H03B	C0G	50	47pF	±5%	3.6	3.5	-	2.5	2.5	0A2	500
	RCE5C1H560J0A2H03B	C0G	50	56pF	±5%	3.6	3.5	-	2.5	2.5	0A2	500
	RCE5C1H680J0A2H03B	C0G	50	68pF	±5%	3.6	3.5	-	2.5	2.5	0A2	500
	RCE5C1H820J0A2H03B	C0G	50	82pF	±5%	3.6	3.5	-	2.5	2.5	0A2	500
	RCE5C1H101J0A2H03B	C0G	50	100pF	±5%	3.6	3.5	-	2.5	2.5	0A2	500
	RCE5C1H121J0A2H03B	C0G	50	120pF	±5%	3.6	3.5	-	2.5	2.5	0A2	500
	RCE5C1H151J0A2H03B	C0G	50	150pF	±5%	3.6	3.5	-	2.5	2.5	0A2	500
	RCE5C1H181J0A2H03B	C0G	50	180pF	±5%	3.6	3.5	-	2.5	2.5	0A2	500
	RCE5C1H221J0A2H03B	C0G	50	220pF	±5%	3.6	3.5	-	2.5	2.5	0A2	500
	RCE5C1H271J0A2H03B	C0G	50	270pF	±5%	3.6	3.5	-	2.5	2.5	0A2	500
	RCE5C1H331J0A2H03B	C0G	50	330pF	±5%	3.6	3.5	-	2.5	2.5	0A2	500
	RCE5C1H391J0A2H03B	C0G	50	390pF	±5%	3.6	3.5	-	2.5	2.5	0A2	500
	RCE5C1H471J0A2H03B	C0G	50	470pF	±5%	3.6	3.5	-	2.5	2.5	0A2	500
	RCE5C1H561J0A2H03B	C0G	50	560pF	±5%	3.6	3.5	-	2.5	2.5	0A2	500
	RCE5C1H681J0A2H03B	C0G	50	680pF	±5%	3.6	3.5	-	2.5	2.5	0A2	500
	RCE5C1H821J0A2H03B	C0G	50	820pF	±5%	3.6	3.5	-	2.5	2.5	0A2	500
	RCE5C1H102J0A2H03B	C0G	50	1000pF	±5%	3.6	3.5	-	2.5	2.5	0A2	500
	RCE5C1H122J0A2H03B	C0G	50	1200pF	±5%	3.6	3.5	-	2.5	2.5	0A2	500
	RCE5C1H152J0A2H03B	C0G	50	1500pF	±5%	3.6	3.5	-	2.5	2.5	0A2	500
	RCE5C1H182J0A2H03B	C0G	50	1800pF	±5%	3.6	3.5	-	2.5	2.5	0A2	500
	RCE5C1H222J0A2H03B	C0G	50	2200pF	±5%	3.6	3.5	-	2.5	2.5	0A2	500
	RCE5C1H272J0A2H03B	C0G	50	2700pF	±5%	3.6	3.5	-	2.5	2.5	0A2	500
	RCE5C1H332J0A2H03B	C0G	50	3300pF	±5%	3.6	3.5	-	2.5	2.5	0A2	500

• Straight Long
(Lead Style:A2)

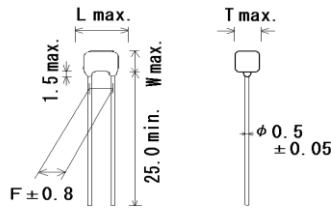

Unit : mm

Customer Part Number	Murata Part Number	T.C.	DC Rated Volt. (V)	Cap.	Cap. Tol.	Dimension (mm)					Dimension (LxW) Lead Style	Pack qty. (pcs)
						L	W	W1	F	T		
	RCE5C1H392J0A2H03B	C0G	50	3900pF	±5%	3.6	3.5	-	2.5	2.5	0A2	500
	RCE5C1H472J1A2H03B	C0G	50	4700pF	±5%	4.0	3.5	-	2.5	2.5	1A2	500
	RCE5C1H562J1A2H03B	C0G	50	5600pF	±5%	4.0	3.5	-	2.5	2.5	1A2	500
	RCE5C1H682J1A2H03B	C0G	50	6800pF	±5%	4.0	3.5	-	2.5	2.5	1A2	500
	RCE5C1H822J1A2H03B	C0G	50	8200pF	±5%	4.0	3.5	-	2.5	2.5	1A2	500
	RCE5C1H103J1A2H03B	C0G	50	10000pF	±5%	4.0	3.5	-	2.5	2.5	1A2	500
	RCE5C1H123J1A2H03B	C0G	50	12000pF	±5%	4.0	3.5	-	2.5	2.5	1A2	500
	RCE5C1H153J1A2H03B	C0G	50	15000pF	±5%	4.0	3.5	-	2.5	2.5	1A2	500
	RCE5C1H183J1A2H03B	C0G	50	18000pF	±5%	4.0	3.5	-	2.5	2.5	1A2	500
	RCE5C1H223J1A2H03B	C0G	50	22000pF	±5%	4.0	3.5	-	2.5	2.5	1A2	500
	RCE5C1H273J2A2H03B	C0G	50	27000pF	±5%	5.5	4.0	-	2.5	3.15	2A2	500
	RCE5C1H333J2A2H03B	C0G	50	33000pF	±5%	5.5	4.0	-	2.5	3.15	2A2	500
	RCE5C1H393J2A2H03B	C0G	50	39000pF	±5%	5.5	4.0	-	2.5	3.15	2A2	500
	RCE5C1H473J2A2H03B	C0G	50	47000pF	±5%	5.5	4.0	-	2.5	3.15	2A2	500
	RCE5C1H563J2A2H03B	C0G	50	56000pF	±5%	5.5	4.0	-	2.5	3.15	2A2	500
	RCE5C1H683J2A2H03B	C0G	50	68000pF	±5%	5.5	4.0	-	2.5	3.15	2A2	500
	RCE5C1H823J2A2H03B	C0G	50	82000pF	±5%	5.5	4.0	-	2.5	3.15	2A2	500
	RCE5C1H104J2A2H03B	C0G	50	0.1μF	±5%	5.5	4.0	-	2.5	3.15	2A2	500
	RCE5C2A1R0C0A2H03B	C0G	100	1pF	±0.25pF	3.6	3.5	-	2.5	2.5	0A2	500
	RCE5C2A2R0C0A2H03B	C0G	100	2pF	±0.25pF	3.6	3.5	-	2.5	2.5	0A2	500
	RCE5C2A3R0C0A2H03B	C0G	100	3pF	±0.25pF	3.6	3.5	-	2.5	2.5	0A2	500
	RCE5C2A4R0C0A2H03B	C0G	100	4pF	±0.25pF	3.6	3.5	-	2.5	2.5	0A2	500
	RCE5C2A5R0C0A2H03B	C0G	100	5pF	±0.25pF	3.6	3.5	-	2.5	2.5	0A2	500
	RCE5C2A6R0D0A2H03B	C0G	100	6pF	±0.5pF	3.6	3.5	-	2.5	2.5	0A2	500
	RCE5C2A7R0D0A2H03B	C0G	100	7pF	±0.5pF	3.6	3.5	-	2.5	2.5	0A2	500
	RCE5C2A8R0D0A2H03B	C0G	100	8pF	±0.5pF	3.6	3.5	-	2.5	2.5	0A2	500
	RCE5C2A9R0D0A2H03B	C0G	100	9pF	±0.5pF	3.6	3.5	-	2.5	2.5	0A2	500
	RCE5C2A100J0A2H03B	C0G	100	10pF	±5%	3.6	3.5	-	2.5	2.5	0A2	500
	RCE5C2A120J0A2H03B	C0G	100	12pF	±5%	3.6	3.5	-	2.5	2.5	0A2	500
	RCE5C2A150J0A2H03B	C0G	100	15pF	±5%	3.6	3.5	-	2.5	2.5	0A2	500
	RCE5C2A180J0A2H03B	C0G	100	18pF	±5%	3.6	3.5	-	2.5	2.5	0A2	500
	RCE5C2A220J0A2H03B	C0G	100	22pF	±5%	3.6	3.5	-	2.5	2.5	0A2	500
	RCE5C2A270J0A2H03B	C0G	100	27pF	±5%	3.6	3.5	-	2.5	2.5	0A2	500
	RCE5C2A330J0A2H03B	C0G	100	33pF	±5%	3.6	3.5	-	2.5	2.5	0A2	500
	RCE5C2A390J0A2H03B	C0G	100	39pF	±5%	3.6	3.5	-	2.5	2.5	0A2	500
	RCE5C2A470J0A2H03B	C0G	100	47pF	±5%	3.6	3.5	-	2.5	2.5	0A2	500
	RCE5C2A560J0A2H03B	C0G	100	56pF	±5%	3.6	3.5	-	2.5	2.5	0A2	500
	RCE5C2A680J0A2H03B	C0G	100	68pF	±5%	3.6	3.5	-	2.5	2.5	0A2	500
	RCE5C2A820J0A2H03B	C0G	100	82pF	±5%	3.6	3.5	-	2.5	2.5	0A2	500
	RCE5C2A101J0A2H03B	C0G	100	100pF	±5%	3.6	3.5	-	2.5	2.5	0A2	500

• Straight Long
(Lead Style:A2)

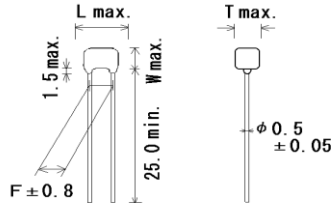

• Inside Crimp
(Lead Style:K*)

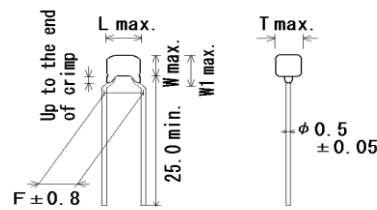

Unit : mm

Customer Part Number	Murata Part Number	T.C.	DC Rated Volt. (V)	Cap.	Cap. Tol.	Dimension (mm)					Dimension (LxW) Lead Style	Pack qty. (pcs)
						L	W	W1	F	T		
	RCE5C2A121J0A2H03B	C0G	100	120pF	±5%	3.6	3.5	-	2.5	2.5	0A2	500
	RCE5C2A151J0A2H03B	C0G	100	150pF	±5%	3.6	3.5	-	2.5	2.5	0A2	500
	RCE5C2A181J0A2H03B	C0G	100	180pF	±5%	3.6	3.5	-	2.5	2.5	0A2	500
	RCE5C2A221J0A2H03B	C0G	100	220pF	±5%	3.6	3.5	-	2.5	2.5	0A2	500
	RCE5C2A271J0A2H03B	C0G	100	270pF	±5%	3.6	3.5	-	2.5	2.5	0A2	500
	RCE5C2A331J0A2H03B	C0G	100	330pF	±5%	3.6	3.5	-	2.5	2.5	0A2	500
	RCE5C2A391J0A2H03B	C0G	100	390pF	±5%	3.6	3.5	-	2.5	2.5	0A2	500
	RCE5C2A471J0A2H03B	C0G	100	470pF	±5%	3.6	3.5	-	2.5	2.5	0A2	500
	RCE5C2A561J0A2H03B	C0G	100	560pF	±5%	3.6	3.5	-	2.5	2.5	0A2	500
	RCE5C2A681J0A2H03B	C0G	100	680pF	±5%	3.6	3.5	-	2.5	2.5	0A2	500
	RCE5C2A821J0A2H03B	C0G	100	820pF	±5%	3.6	3.5	-	2.5	2.5	0A2	500
	RCE5C2A102J0A2H03B	C0G	100	1000pF	±5%	3.6	3.5	-	2.5	2.5	0A2	500
	RCE5C2A122J0A2H03B	C0G	100	1200pF	±5%	3.6	3.5	-	2.5	2.5	0A2	500
	RCE5C2A152J0A2H03B	C0G	100	1500pF	±5%	3.6	3.5	-	2.5	2.5	0A2	500
	RCE5C2A182J1A2H03B	C0G	100	1800pF	±5%	4.0	3.5	-	2.5	2.5	1A2	500
	RCE5C2A222J1A2H03B	C0G	100	2200pF	±5%	4.0	3.5	-	2.5	2.5	1A2	500
	RCE5C2A272J1A2H03B	C0G	100	2700pF	±5%	4.0	3.5	-	2.5	2.5	1A2	500
	RCE5C2A332J1A2H03B	C0G	100	3300pF	±5%	4.0	3.5	-	2.5	2.5	1A2	500
	RCE5C2A392J2A2H03B	C0G	100	3900pF	±5%	5.5	4.0	-	2.5	3.15	2A2	500
	RCE5C2A472J2A2H03B	C0G	100	4700pF	±5%	5.5	4.0	-	2.5	3.15	2A2	500
	RCE5C2A562J2A2H03B	C0G	100	5600pF	±5%	5.5	4.0	-	2.5	3.15	2A2	500
	RCE5C2A682J2A2H03B	C0G	100	6800pF	±5%	5.5	4.0	-	2.5	3.15	2A2	500
	RCE5C2A822J2A2H03B	C0G	100	8200pF	±5%	5.5	4.0	-	2.5	3.15	2A2	500
	RCE5C2A103J2A2H03B	C0G	100	10000pF	±5%	5.5	4.0	-	2.5	3.15	2A2	500
	RCE5C1H1R0C0K1H03B	C0G	50	1pF	±0.25pF	3.6	3.5	6.0	5.0	2.5	0K1	500
	RCE5C1H2R0C0K1H03B	C0G	50	2pF	±0.25pF	3.6	3.5	6.0	5.0	2.5	0K1	500
	RCE5C1H3R0C0K1H03B	C0G	50	3pF	±0.25pF	3.6	3.5	6.0	5.0	2.5	0K1	500
	RCE5C1H4R0C0K1H03B	C0G	50	4pF	±0.25pF	3.6	3.5	6.0	5.0	2.5	0K1	500
	RCE5C1H5R0C0K1H03B	C0G	50	5pF	±0.25pF	3.6	3.5	6.0	5.0	2.5	0K1	500
	RCE5C1H6R0D0K1H03B	C0G	50	6pF	±0.5pF	3.6	3.5	6.0	5.0	2.5	0K1	500
	RCE5C1H7R0D0K1H03B	C0G	50	7pF	±0.5pF	3.6	3.5	6.0	5.0	2.5	0K1	500
	RCE5C1H8R0D0K1H03B	C0G	50	8pF	±0.5pF	3.6	3.5	6.0	5.0	2.5	0K1	500
	RCE5C1H9R0D0K1H03B	C0G	50	9pF	±0.5pF	3.6	3.5	6.0	5.0	2.5	0K1	500
	RCE5C1H100J0K1H03B	C0G	50	10pF	±5%	3.6	3.5	6.0	5.0	2.5	0K1	500
	RCE5C1H120J0K1H03B	C0G	50	12pF	±5%	3.6	3.5	6.0	5.0	2.5	0K1	500
	RCE5C1H150J0K1H03B	C0G	50	15pF	±5%	3.6	3.5	6.0	5.0	2.5	0K1	500
	RCE5C1H180J0K1H03B	C0G	50	18pF	±5%	3.6	3.5	6.0	5.0	2.5	0K1	500
	RCE5C1H220J0K1H03B	C0G	50	22pF	±5%	3.6	3.5	6.0	5.0	2.5	0K1	500
	RCE5C1H270J0K1H03B	C0G	50	27pF	±5%	3.6	3.5	6.0	5.0	2.5	0K1	500
	RCE5C1H330J0K1H03B	C0G	50	33pF	±5%	3.6	3.5	6.0	5.0	2.5	0K1	500

- Inside Crimp
(Lead Style:K*)

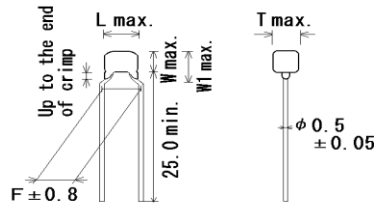

Unit : mm

Customer Part Number	Murata Part Number	T.C.	DC Rated Volt. (V)	Cap.	Cap. Tol.	Dimension (mm)					Dimension (LxW) Lead Style	Pack qty. (pcs)
						L	W	W1	F	T		
	RCE5C1H390J0K1H03B	C0G	50	39pF	±5%	3.6	3.5	6.0	5.0	2.5	0K1	500
	RCE5C1H470J0K1H03B	C0G	50	47pF	±5%	3.6	3.5	6.0	5.0	2.5	0K1	500
	RCE5C1H560J0K1H03B	C0G	50	56pF	±5%	3.6	3.5	6.0	5.0	2.5	0K1	500
	RCE5C1H680J0K1H03B	C0G	50	68pF	±5%	3.6	3.5	6.0	5.0	2.5	0K1	500
	RCE5C1H820J0K1H03B	C0G	50	82pF	±5%	3.6	3.5	6.0	5.0	2.5	0K1	500
	RCE5C1H101J0K1H03B	C0G	50	100pF	±5%	3.6	3.5	6.0	5.0	2.5	0K1	500
	RCE5C1H121J0K1H03B	C0G	50	120pF	±5%	3.6	3.5	6.0	5.0	2.5	0K1	500
	RCE5C1H151J0K1H03B	C0G	50	150pF	±5%	3.6	3.5	6.0	5.0	2.5	0K1	500
	RCE5C1H181J0K1H03B	C0G	50	180pF	±5%	3.6	3.5	6.0	5.0	2.5	0K1	500
	RCE5C1H221J0K1H03B	C0G	50	220pF	±5%	3.6	3.5	6.0	5.0	2.5	0K1	500
	RCE5C1H271J0K1H03B	C0G	50	270pF	±5%	3.6	3.5	6.0	5.0	2.5	0K1	500
	RCE5C1H331J0K1H03B	C0G	50	330pF	±5%	3.6	3.5	6.0	5.0	2.5	0K1	500
	RCE5C1H391J0K1H03B	C0G	50	390pF	±5%	3.6	3.5	6.0	5.0	2.5	0K1	500
	RCE5C1H471J0K1H03B	C0G	50	470pF	±5%	3.6	3.5	6.0	5.0	2.5	0K1	500
	RCE5C1H561J0K1H03B	C0G	50	560pF	±5%	3.6	3.5	6.0	5.0	2.5	0K1	500
	RCE5C1H681J0K1H03B	C0G	50	680pF	±5%	3.6	3.5	6.0	5.0	2.5	0K1	500
	RCE5C1H821J0K1H03B	C0G	50	820pF	±5%	3.6	3.5	6.0	5.0	2.5	0K1	500
	RCE5C1H102J0K1H03B	C0G	50	1000pF	±5%	3.6	3.5	6.0	5.0	2.5	0K1	500
	RCE5C1H122J0K1H03B	C0G	50	1200pF	±5%	3.6	3.5	6.0	5.0	2.5	0K1	500
	RCE5C1H152J0K1H03B	C0G	50	1500pF	±5%	3.6	3.5	6.0	5.0	2.5	0K1	500
	RCE5C1H182J0K1H03B	C0G	50	1800pF	±5%	3.6	3.5	6.0	5.0	2.5	0K1	500
	RCE5C1H222J0K1H03B	C0G	50	2200pF	±5%	3.6	3.5	6.0	5.0	2.5	0K1	500
	RCE5C1H272J0K1H03B	C0G	50	2700pF	±5%	3.6	3.5	6.0	5.0	2.5	0K1	500
	RCE5C1H332J0K1H03B	C0G	50	3300pF	±5%	3.6	3.5	6.0	5.0	2.5	0K1	500
	RCE5C1H392J0K1H03B	C0G	50	3900pF	±5%	3.6	3.5	6.0	5.0	2.5	0K1	500
	RCE5C1H472J1K1H03B	C0G	50	4700pF	±5%	4.0	3.5	5.0	5.0	2.5	1K1	500
	RCE5C1H562J1K1H03B	C0G	50	5600pF	±5%	4.0	3.5	5.0	5.0	2.5	1K1	500
	RCE5C1H682J1K1H03B	C0G	50	6800pF	±5%	4.0	3.5	5.0	5.0	2.5	1K1	500
	RCE5C1H822J1K1H03B	C0G	50	8200pF	±5%	4.0	3.5	5.0	5.0	2.5	1K1	500
	RCE5C1H103J1K1H03B	C0G	50	10000pF	±5%	4.0	3.5	5.0	5.0	2.5	1K1	500
	RCE5C1H123J1K1H03B	C0G	50	12000pF	±5%	4.0	3.5	5.0	5.0	2.5	1K1	500
	RCE5C1H153J1K1H03B	C0G	50	15000pF	±5%	4.0	3.5	5.0	5.0	2.5	1K1	500
	RCE5C1H183J1K1H03B	C0G	50	18000pF	±5%	4.0	3.5	5.0	5.0	2.5	1K1	500
	RCE5C1H223J1K1H03B	C0G	50	22000pF	±5%	4.0	3.5	5.0	5.0	2.5	1K1	500
	RCE5C1H273J2K1H03B	C0G	50	27000pF	±5%	5.5	4.0	6.0	5.0	3.15	2K1	500
	RCE5C1H333J2K1H03B	C0G	50	33000pF	±5%	5.5	4.0	6.0	5.0	3.15	2K1	500
	RCE5C1H393J2K1H03B	C0G	50	39000pF	±5%	5.5	4.0	6.0	5.0	3.15	2K1	500
	RCE5C1H473J2K1H03B	C0G	50	47000pF	±5%	5.5	4.0	6.0	5.0	3.15	2K1	500
	RCE5C1H563J2K1H03B	C0G	50	56000pF	±5%	5.5	4.0	6.0	5.0	3.15	2K1	500
	RCE5C1H683J2K1H03B	C0G	50	68000pF	±5%	5.5	4.0	6.0	5.0	3.15	2K1	500

- Inside Crimp
(Lead Style:K*)

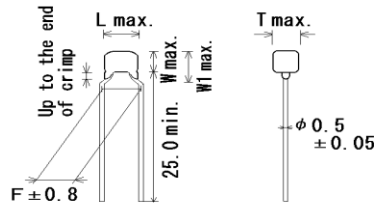

Unit : mm

Customer Part Number	Murata Part Number	T.C.	DC Rated Volt. (V)	Cap.	Cap. Tol.	Dimension (mm)					Dimension (LxW) Lead Style	Pack qty. (pcs)
						L	W	W1	F	T		
	RCE5C1H823J2K1H03B	C0G	50	8200pF	±5%	5.5	4.0	6.0	5.0	3.15	2K1	500
	RCE5C1H104J2K1H03B	C0G	50	0.1μF	±5%	5.5	4.0	6.0	5.0	3.15	2K1	500
	RCE5C2A1R0C0K1H03B	C0G	100	1pF	±0.25pF	3.6	3.5	6.0	5.0	2.5	0K1	500
	RCE5C2A2R0C0K1H03B	C0G	100	2pF	±0.25pF	3.6	3.5	6.0	5.0	2.5	0K1	500
	RCE5C2A3R0C0K1H03B	C0G	100	3pF	±0.25pF	3.6	3.5	6.0	5.0	2.5	0K1	500
	RCE5C2A4R0C0K1H03B	C0G	100	4pF	±0.25pF	3.6	3.5	6.0	5.0	2.5	0K1	500
	RCE5C2A5R0C0K1H03B	C0G	100	5pF	±0.25pF	3.6	3.5	6.0	5.0	2.5	0K1	500
	RCE5C2A6R0D0K1H03B	C0G	100	6pF	±0.5pF	3.6	3.5	6.0	5.0	2.5	0K1	500
	RCE5C2A7R0D0K1H03B	C0G	100	7pF	±0.5pF	3.6	3.5	6.0	5.0	2.5	0K1	500
	RCE5C2A8R0D0K1H03B	C0G	100	8pF	±0.5pF	3.6	3.5	6.0	5.0	2.5	0K1	500
	RCE5C2A9R0D0K1H03B	C0G	100	9pF	±0.5pF	3.6	3.5	6.0	5.0	2.5	0K1	500
	RCE5C2A100J0K1H03B	C0G	100	10pF	±5%	3.6	3.5	6.0	5.0	2.5	0K1	500
	RCE5C2A120J0K1H03B	C0G	100	12pF	±5%	3.6	3.5	6.0	5.0	2.5	0K1	500
	RCE5C2A150J0K1H03B	C0G	100	15pF	±5%	3.6	3.5	6.0	5.0	2.5	0K1	500
	RCE5C2A180J0K1H03B	C0G	100	18pF	±5%	3.6	3.5	6.0	5.0	2.5	0K1	500
	RCE5C2A220J0K1H03B	C0G	100	22pF	±5%	3.6	3.5	6.0	5.0	2.5	0K1	500
	RCE5C2A270J0K1H03B	C0G	100	27pF	±5%	3.6	3.5	6.0	5.0	2.5	0K1	500
	RCE5C2A330J0K1H03B	C0G	100	33pF	±5%	3.6	3.5	6.0	5.0	2.5	0K1	500
	RCE5C2A390J0K1H03B	C0G	100	39pF	±5%	3.6	3.5	6.0	5.0	2.5	0K1	500
	RCE5C2A470J0K1H03B	C0G	100	47pF	±5%	3.6	3.5	6.0	5.0	2.5	0K1	500
	RCE5C2A560J0K1H03B	C0G	100	56pF	±5%	3.6	3.5	6.0	5.0	2.5	0K1	500
	RCE5C2A680J0K1H03B	C0G	100	68pF	±5%	3.6	3.5	6.0	5.0	2.5	0K1	500
	RCE5C2A820J0K1H03B	C0G	100	82pF	±5%	3.6	3.5	6.0	5.0	2.5	0K1	500
	RCE5C2A101J0K1H03B	C0G	100	100pF	±5%	3.6	3.5	6.0	5.0	2.5	0K1	500
	RCE5C2A121J0K1H03B	C0G	100	120pF	±5%	3.6	3.5	6.0	5.0	2.5	0K1	500
	RCE5C2A151J0K1H03B	C0G	100	150pF	±5%	3.6	3.5	6.0	5.0	2.5	0K1	500
	RCE5C2A181J0K1H03B	C0G	100	180pF	±5%	3.6	3.5	6.0	5.0	2.5	0K1	500
	RCE5C2A221J0K1H03B	C0G	100	220pF	±5%	3.6	3.5	6.0	5.0	2.5	0K1	500
	RCE5C2A271J0K1H03B	C0G	100	270pF	±5%	3.6	3.5	6.0	5.0	2.5	0K1	500
	RCE5C2A331J0K1H03B	C0G	100	330pF	±5%	3.6	3.5	6.0	5.0	2.5	0K1	500
	RCE5C2A391J0K1H03B	C0G	100	390pF	±5%	3.6	3.5	6.0	5.0	2.5	0K1	500
	RCE5C2A471J0K1H03B	C0G	100	470pF	±5%	3.6	3.5	6.0	5.0	2.5	0K1	500
	RCE5C2A561J0K1H03B	C0G	100	560pF	±5%	3.6	3.5	6.0	5.0	2.5	0K1	500
	RCE5C2A681J0K1H03B	C0G	100	680pF	±5%	3.6	3.5	6.0	5.0	2.5	0K1	500
	RCE5C2A821J0K1H03B	C0G	100	820pF	±5%	3.6	3.5	6.0	5.0	2.5	0K1	500
	RCE5C2A102J0K1H03B	C0G	100	1000pF	±5%	3.6	3.5	6.0	5.0	2.5	0K1	500
	RCE5C2A122J0K1H03B	C0G	100	1200pF	±5%	3.6	3.5	6.0	5.0	2.5	0K1	500
	RCE5C2A152J0K1H03B	C0G	100	1500pF	±5%	3.6	3.5	6.0	5.0	2.5	0K1	500
	RCE5C2A182J1K1H03B	C0G	100	1800pF	±5%	4.0	3.5	5.0	5.0	2.5	1K1	500
	RCE5C2A222J1K1H03B	C0G	100	2200pF	±5%	4.0	3.5	5.0	5.0	2.5	1K1	500

- Inside Crimp
(Lead Style:K*)

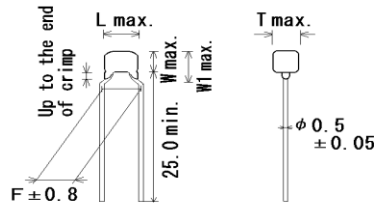

Unit : mm

Customer Part Number	Murata Part Number	T.C.	DC Rated Volt. (V)	Cap.	Cap. Tol.	Dimension (mm)					Dimension (LxW) Lead Style	Pack qty. (pcs)
						L	W	W1	F	T		
	RCE5C2A272J1K1H03B	C0G	100	2700pF	±5%	4.0	3.5	5.0	5.0	2.5	1K1	500
	RCE5C2A332J1K1H03B	C0G	100	3300pF	±5%	4.0	3.5	5.0	5.0	2.5	1K1	500
	RCE5C2A392J2K1H03B	C0G	100	3900pF	±5%	5.5	4.0	6.0	5.0	3.15	2K1	500
	RCE5C2A472J2K1H03B	C0G	100	4700pF	±5%	5.5	4.0	6.0	5.0	3.15	2K1	500
	RCE5C2A562J2K1H03B	C0G	100	5600pF	±5%	5.5	4.0	6.0	5.0	3.15	2K1	500
	RCE5C2A682J2K1H03B	C0G	100	6800pF	±5%	5.5	4.0	6.0	5.0	3.15	2K1	500
	RCE5C2A822J2K1H03B	C0G	100	8200pF	±5%	5.5	4.0	6.0	5.0	3.15	2K1	500
	RCE5C2A103J2K1H03B	C0G	100	10000pF	±5%	5.5	4.0	6.0	5.0	3.15	2K1	500

• Straight Taping
(Lead Style:D*)

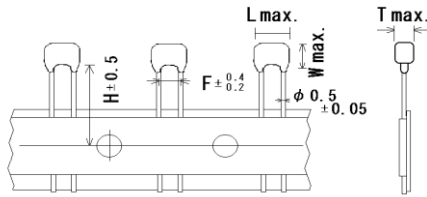

Unit : mm

Customer Part Number	Murata Part Number	T.C.	DC Rated Volt. (V)	Cap.	Cap. Tol.	Dimension (mm)						Dimension (LxW) Lead Style	Pack qty. (pcs)
						L	W	W1	F	T	H/H0		
	RCE5C1H1R0C0DBH03A	C0G	50	1pF	±0.25pF	3.6	3.5	-	2.5	2.5	16.0	0DB	2000
	RCE5C1H2R0C0DBH03A	C0G	50	2pF	±0.25pF	3.6	3.5	-	2.5	2.5	16.0	0DB	2000
	RCE5C1H3R0C0DBH03A	C0G	50	3pF	±0.25pF	3.6	3.5	-	2.5	2.5	16.0	0DB	2000
	RCE5C1H4R0C0DBH03A	C0G	50	4pF	±0.25pF	3.6	3.5	-	2.5	2.5	16.0	0DB	2000
	RCE5C1H5R0C0DBH03A	C0G	50	5pF	±0.25pF	3.6	3.5	-	2.5	2.5	16.0	0DB	2000
	RCE5C1H6R0D0DBH03A	C0G	50	6pF	±0.5pF	3.6	3.5	-	2.5	2.5	16.0	0DB	2000
	RCE5C1H7R0D0DBH03A	C0G	50	7pF	±0.5pF	3.6	3.5	-	2.5	2.5	16.0	0DB	2000
	RCE5C1H8R0D0DBH03A	C0G	50	8pF	±0.5pF	3.6	3.5	-	2.5	2.5	16.0	0DB	2000
	RCE5C1H9R0D0DBH03A	C0G	50	9pF	±0.5pF	3.6	3.5	-	2.5	2.5	16.0	0DB	2000
	RCE5C1H100J0DBH03A	C0G	50	10pF	±5%	3.6	3.5	-	2.5	2.5	16.0	0DB	2000
	RCE5C1H120J0DBH03A	C0G	50	12pF	±5%	3.6	3.5	-	2.5	2.5	16.0	0DB	2000
	RCE5C1H150J0DBH03A	C0G	50	15pF	±5%	3.6	3.5	-	2.5	2.5	16.0	0DB	2000
	RCE5C1H180J0DBH03A	C0G	50	18pF	±5%	3.6	3.5	-	2.5	2.5	16.0	0DB	2000
	RCE5C1H220J0DBH03A	C0G	50	22pF	±5%	3.6	3.5	-	2.5	2.5	16.0	0DB	2000
	RCE5C1H270J0DBH03A	C0G	50	27pF	±5%	3.6	3.5	-	2.5	2.5	16.0	0DB	2000
	RCE5C1H330J0DBH03A	C0G	50	33pF	±5%	3.6	3.5	-	2.5	2.5	16.0	0DB	2000
	RCE5C1H390J0DBH03A	C0G	50	39pF	±5%	3.6	3.5	-	2.5	2.5	16.0	0DB	2000
	RCE5C1H470J0DBH03A	C0G	50	47pF	±5%	3.6	3.5	-	2.5	2.5	16.0	0DB	2000
	RCE5C1H560J0DBH03A	C0G	50	56pF	±5%	3.6	3.5	-	2.5	2.5	16.0	0DB	2000
	RCE5C1H680J0DBH03A	C0G	50	68pF	±5%	3.6	3.5	-	2.5	2.5	16.0	0DB	2000
	RCE5C1H820J0DBH03A	C0G	50	82pF	±5%	3.6	3.5	-	2.5	2.5	16.0	0DB	2000
	RCE5C1H101J0DBH03A	C0G	50	100pF	±5%	3.6	3.5	-	2.5	2.5	16.0	0DB	2000
	RCE5C1H121J0DBH03A	C0G	50	120pF	±5%	3.6	3.5	-	2.5	2.5	16.0	0DB	2000
	RCE5C1H151J0DBH03A	C0G	50	150pF	±5%	3.6	3.5	-	2.5	2.5	16.0	0DB	2000
	RCE5C1H181J0DBH03A	C0G	50	180pF	±5%	3.6	3.5	-	2.5	2.5	16.0	0DB	2000
	RCE5C1H221J0DBH03A	C0G	50	220pF	±5%	3.6	3.5	-	2.5	2.5	16.0	0DB	2000
	RCE5C1H271J0DBH03A	C0G	50	270pF	±5%	3.6	3.5	-	2.5	2.5	16.0	0DB	2000
	RCE5C1H331J0DBH03A	C0G	50	330pF	±5%	3.6	3.5	-	2.5	2.5	16.0	0DB	2000
	RCE5C1H391J0DBH03A	C0G	50	390pF	±5%	3.6	3.5	-	2.5	2.5	16.0	0DB	2000
	RCE5C1H471J0DBH03A	C0G	50	470pF	±5%	3.6	3.5	-	2.5	2.5	16.0	0DB	2000
	RCE5C1H561J0DBH03A	C0G	50	560pF	±5%	3.6	3.5	-	2.5	2.5	16.0	0DB	2000
	RCE5C1H681J0DBH03A	C0G	50	680pF	±5%	3.6	3.5	-	2.5	2.5	16.0	0DB	2000
	RCE5C1H821J0DBH03A	C0G	50	820pF	±5%	3.6	3.5	-	2.5	2.5	16.0	0DB	2000
	RCE5C1H102J0DBH03A	C0G	50	1000pF	±5%	3.6	3.5	-	2.5	2.5	16.0	0DB	2000
	RCE5C1H122J0DBH03A	C0G	50	1200pF	±5%	3.6	3.5	-	2.5	2.5	16.0	0DB	2000
	RCE5C1H152J0DBH03A	C0G	50	1500pF	±5%	3.6	3.5	-	2.5	2.5	16.0	0DB	2000
	RCE5C1H182J0DBH03A	C0G	50	1800pF	±5%	3.6	3.5	-	2.5	2.5	16.0	0DB	2000
	RCE5C1H222J0DBH03A	C0G	50	2200pF	±5%	3.6	3.5	-	2.5	2.5	16.0	0DB	2000
	RCE5C1H272J0DBH03A	C0G	50	2700pF	±5%	3.6	3.5	-	2.5	2.5	16.0	0DB	2000
	RCE5C1H332J0DBH03A	C0G	50	3300pF	±5%	3.6	3.5	-	2.5	2.5	16.0	0DB	2000

• Straight Taping
(Lead Style:D*)

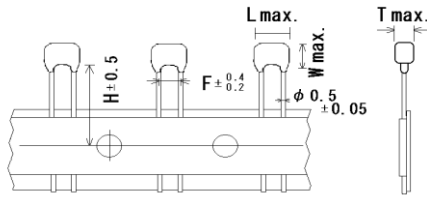

Unit : mm

Customer Part Number	Murata Part Number	T.C.	DC Rated Volt. (V)	Cap.	Cap. Tol.	Dimension (mm)						Dimension (LxW) Lead Style	Pack qty. (pcs)
						L	W	W1	F	T	H/HO		
	RCE5C1H392J0DBH03A	C0G	50	3900pF	±5%	3.6	3.5	-	2.5	2.5	16.0	0DB	2000
	RCE5C1H472J1DBH03A	C0G	50	4700pF	±5%	4.0	3.5	-	2.5	2.5	16.0	1DB	2000
	RCE5C1H562J1DBH03A	C0G	50	5600pF	±5%	4.0	3.5	-	2.5	2.5	16.0	1DB	2000
	RCE5C1H682J1DBH03A	C0G	50	6800pF	±5%	4.0	3.5	-	2.5	2.5	16.0	1DB	2000
	RCE5C1H822J1DBH03A	C0G	50	8200pF	±5%	4.0	3.5	-	2.5	2.5	16.0	1DB	2000
	RCE5C1H103J1DBH03A	C0G	50	10000pF	±5%	4.0	3.5	-	2.5	2.5	16.0	1DB	2000
	RCE5C1H123J1DBH03A	C0G	50	12000pF	±5%	4.0	3.5	-	2.5	2.5	16.0	1DB	2000
	RCE5C1H153J1DBH03A	C0G	50	15000pF	±5%	4.0	3.5	-	2.5	2.5	16.0	1DB	2000
	RCE5C1H183J1DBH03A	C0G	50	18000pF	±5%	4.0	3.5	-	2.5	2.5	16.0	1DB	2000
	RCE5C1H223J1DBH03A	C0G	50	22000pF	±5%	4.0	3.5	-	2.5	2.5	16.0	1DB	2000
	RCE5C1H273J2DBH03A	C0G	50	27000pF	±5%	5.5	4.0	-	2.5	3.15	16.0	2DB	2000
	RCE5C1H333J2DBH03A	C0G	50	33000pF	±5%	5.5	4.0	-	2.5	3.15	16.0	2DB	2000
	RCE5C1H393J2DBH03A	C0G	50	39000pF	±5%	5.5	4.0	-	2.5	3.15	16.0	2DB	2000
	RCE5C1H473J2DBH03A	C0G	50	47000pF	±5%	5.5	4.0	-	2.5	3.15	16.0	2DB	2000
	RCE5C1H563J2DBH03A	C0G	50	56000pF	±5%	5.5	4.0	-	2.5	3.15	16.0	2DB	2000
	RCE5C1H683J2DBH03A	C0G	50	68000pF	±5%	5.5	4.0	-	2.5	3.15	16.0	2DB	2000
	RCE5C1H823J2DBH03A	C0G	50	82000pF	±5%	5.5	4.0	-	2.5	3.15	16.0	2DB	2000
	RCE5C1H104J2DBH03A	C0G	50	0.1μF	±5%	5.5	4.0	-	2.5	3.15	16.0	2DB	2000
	RCE5C2A1R0C0DBH03A	C0G	100	1pF	±0.25pF	3.6	3.5	-	2.5	2.5	16.0	0DB	2000
	RCE5C2A2R0C0DBH03A	C0G	100	2pF	±0.25pF	3.6	3.5	-	2.5	2.5	16.0	0DB	2000
	RCE5C2A3R0C0DBH03A	C0G	100	3pF	±0.25pF	3.6	3.5	-	2.5	2.5	16.0	0DB	2000
	RCE5C2A4R0C0DBH03A	C0G	100	4pF	±0.25pF	3.6	3.5	-	2.5	2.5	16.0	0DB	2000
	RCE5C2A5R0C0DBH03A	C0G	100	5pF	±0.25pF	3.6	3.5	-	2.5	2.5	16.0	0DB	2000
	RCE5C2A6R0D0DBH03A	C0G	100	6pF	±0.5pF	3.6	3.5	-	2.5	2.5	16.0	0DB	2000
	RCE5C2A7R0D0DBH03A	C0G	100	7pF	±0.5pF	3.6	3.5	-	2.5	2.5	16.0	0DB	2000
	RCE5C2A8R0D0DBH03A	C0G	100	8pF	±0.5pF	3.6	3.5	-	2.5	2.5	16.0	0DB	2000
	RCE5C2A9R0D0DBH03A	C0G	100	9pF	±0.5pF	3.6	3.5	-	2.5	2.5	16.0	0DB	2000
	RCE5C2A100J0DBH03A	C0G	100	10pF	±5%	3.6	3.5	-	2.5	2.5	16.0	0DB	2000
	RCE5C2A120J0DBH03A	C0G	100	12pF	±5%	3.6	3.5	-	2.5	2.5	16.0	0DB	2000
	RCE5C2A150J0DBH03A	C0G	100	15pF	±5%	3.6	3.5	-	2.5	2.5	16.0	0DB	2000
	RCE5C2A180J0DBH03A	C0G	100	18pF	±5%	3.6	3.5	-	2.5	2.5	16.0	0DB	2000
	RCE5C2A220J0DBH03A	C0G	100	22pF	±5%	3.6	3.5	-	2.5	2.5	16.0	0DB	2000
	RCE5C2A270J0DBH03A	C0G	100	27pF	±5%	3.6	3.5	-	2.5	2.5	16.0	0DB	2000
	RCE5C2A330J0DBH03A	C0G	100	33pF	±5%	3.6	3.5	-	2.5	2.5	16.0	0DB	2000
	RCE5C2A390J0DBH03A	C0G	100	39pF	±5%	3.6	3.5	-	2.5	2.5	16.0	0DB	2000
	RCE5C2A470J0DBH03A	C0G	100	47pF	±5%	3.6	3.5	-	2.5	2.5	16.0	0DB	2000
	RCE5C2A560J0DBH03A	C0G	100	56pF	±5%	3.6	3.5	-	2.5	2.5	16.0	0DB	2000
	RCE5C2A680J0DBH03A	C0G	100	68pF	±5%	3.6	3.5	-	2.5	2.5	16.0	0DB	2000
	RCE5C2A820J0DBH03A	C0G	100	82pF	±5%	3.6	3.5	-	2.5	2.5	16.0	0DB	2000
	RCE5C2A101J0DBH03A	C0G	100	100pF	±5%	3.6	3.5	-	2.5	2.5	16.0	0DB	2000

• Straight Taping
(Lead Style: D*)

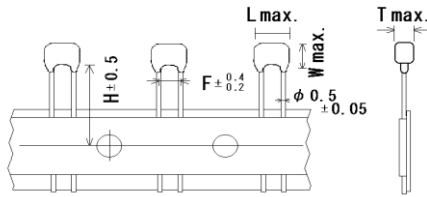

• Inside Crimp Taping
(Lead Style: M*)

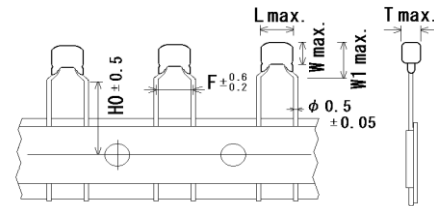

Unit : mm

Customer Part Number	Murata Part Number	T.C.	DC Rated Volt. (V)	Cap.	Cap. Tol.	Dimension (mm)						Dimension (LxW) Lead Style	Pack qty. (pcs)
						L	W	W1	F	T	H/HO		
	RCE5C2A121J0DBH03A	C0G	100	120pF	±5%	3.6	3.5	-	2.5	2.5	16.0	0DB	2000
	RCE5C2A151J0DBH03A	C0G	100	150pF	±5%	3.6	3.5	-	2.5	2.5	16.0	0DB	2000
	RCE5C2A181J0DBH03A	C0G	100	180pF	±5%	3.6	3.5	-	2.5	2.5	16.0	0DB	2000
	RCE5C2A221J0DBH03A	C0G	100	220pF	±5%	3.6	3.5	-	2.5	2.5	16.0	0DB	2000
	RCE5C2A271J0DBH03A	C0G	100	270pF	±5%	3.6	3.5	-	2.5	2.5	16.0	0DB	2000
	RCE5C2A331J0DBH03A	C0G	100	330pF	±5%	3.6	3.5	-	2.5	2.5	16.0	0DB	2000
	RCE5C2A391J0DBH03A	C0G	100	390pF	±5%	3.6	3.5	-	2.5	2.5	16.0	0DB	2000
	RCE5C2A471J0DBH03A	C0G	100	470pF	±5%	3.6	3.5	-	2.5	2.5	16.0	0DB	2000
	RCE5C2A561J0DBH03A	C0G	100	560pF	±5%	3.6	3.5	-	2.5	2.5	16.0	0DB	2000
	RCE5C2A681J0DBH03A	C0G	100	680pF	±5%	3.6	3.5	-	2.5	2.5	16.0	0DB	2000
	RCE5C2A821J0DBH03A	C0G	100	820pF	±5%	3.6	3.5	-	2.5	2.5	16.0	0DB	2000
	RCE5C2A102J0DBH03A	C0G	100	1000pF	±5%	3.6	3.5	-	2.5	2.5	16.0	0DB	2000
	RCE5C2A122J0DBH03A	C0G	100	1200pF	±5%	3.6	3.5	-	2.5	2.5	16.0	0DB	2000
	RCE5C2A152J0DBH03A	C0G	100	1500pF	±5%	3.6	3.5	-	2.5	2.5	16.0	0DB	2000
	RCE5C2A182J1DBH03A	C0G	100	1800pF	±5%	4.0	3.5	-	2.5	2.5	16.0	1DB	2000
	RCE5C2A222J1DBH03A	C0G	100	2200pF	±5%	4.0	3.5	-	2.5	2.5	16.0	1DB	2000
	RCE5C2A272J1DBH03A	C0G	100	2700pF	±5%	4.0	3.5	-	2.5	2.5	16.0	1DB	2000
	RCE5C2A332J1DBH03A	C0G	100	3300pF	±5%	4.0	3.5	-	2.5	2.5	16.0	1DB	2000
	RCE5C2A392J2DBH03A	C0G	100	3900pF	±5%	5.5	4.0	-	2.5	3.15	16.0	2DB	2000
	RCE5C2A472J2DBH03A	C0G	100	4700pF	±5%	5.5	4.0	-	2.5	3.15	16.0	2DB	2000
	RCE5C2A562J2DBH03A	C0G	100	5600pF	±5%	5.5	4.0	-	2.5	3.15	16.0	2DB	2000
	RCE5C2A682J2DBH03A	C0G	100	6800pF	±5%	5.5	4.0	-	2.5	3.15	16.0	2DB	2000
	RCE5C2A822J2DBH03A	C0G	100	8200pF	±5%	5.5	4.0	-	2.5	3.15	16.0	2DB	2000
	RCE5C2A103J2DBH03A	C0G	100	10000pF	±5%	5.5	4.0	-	2.5	3.15	16.0	2DB	2000
	RCE5C1H1R0C0M1H03A	C0G	50	1pF	±0.25pF	3.6	3.5	6.0	5.0	2.5	16.0	0M1	2000
	RCE5C1H2R0C0M1H03A	C0G	50	2pF	±0.25pF	3.6	3.5	6.0	5.0	2.5	16.0	0M1	2000
	RCE5C1H3R0C0M1H03A	C0G	50	3pF	±0.25pF	3.6	3.5	6.0	5.0	2.5	16.0	0M1	2000
	RCE5C1H4R0C0M1H03A	C0G	50	4pF	±0.25pF	3.6	3.5	6.0	5.0	2.5	16.0	0M1	2000
	RCE5C1H5R0C0M1H03A	C0G	50	5pF	±0.25pF	3.6	3.5	6.0	5.0	2.5	16.0	0M1	2000
	RCE5C1H6R0D0M1H03A	C0G	50	6pF	±0.5pF	3.6	3.5	6.0	5.0	2.5	16.0	0M1	2000
	RCE5C1H7R0D0M1H03A	C0G	50	7pF	±0.5pF	3.6	3.5	6.0	5.0	2.5	16.0	0M1	2000
	RCE5C1H8R0D0M1H03A	C0G	50	8pF	±0.5pF	3.6	3.5	6.0	5.0	2.5	16.0	0M1	2000
	RCE5C1H9R0D0M1H03A	C0G	50	9pF	±0.5pF	3.6	3.5	6.0	5.0	2.5	16.0	0M1	2000
	RCE5C1H100J0M1H03A	C0G	50	10pF	±5%	3.6	3.5	6.0	5.0	2.5	16.0	0M1	2000
	RCE5C1H120J0M1H03A	C0G	50	12pF	±5%	3.6	3.5	6.0	5.0	2.5	16.0	0M1	2000
	RCE5C1H150J0M1H03A	C0G	50	15pF	±5%	3.6	3.5	6.0	5.0	2.5	16.0	0M1	2000
	RCE5C1H180J0M1H03A	C0G	50	18pF	±5%	3.6	3.5	6.0	5.0	2.5	16.0	0M1	2000
	RCE5C1H220J0M1H03A	C0G	50	22pF	±5%	3.6	3.5	6.0	5.0	2.5	16.0	0M1	2000
	RCE5C1H270J0M1H03A	C0G	50	27pF	±5%	3.6	3.5	6.0	5.0	2.5	16.0	0M1	2000
	RCE5C1H330J0M1H03A	C0G	50	33pF	±5%	3.6	3.5	6.0	5.0	2.5	16.0	0M1	2000

• Inside Crimp Taping
(Lead Style: M*)

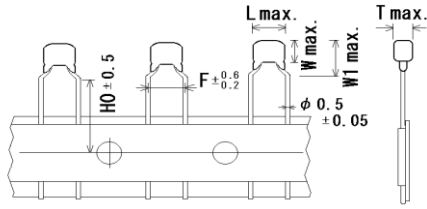

Unit : mm

Customer Part Number	Murata Part Number	T.C.	DC Rated Volt. (V)	Cap.	Cap. Tol.	Dimension (mm)						Dimension (LxW) Lead Style	Pack qty. (pcs)
						L	W	W1	F	T	H/HO		
	RCE5C1H390J0M1H03A	C0G	50	39pF	±5%	3.6	3.5	6.0	5.0	2.5	16.0	0M1	2000
	RCE5C1H470J0M1H03A	C0G	50	47pF	±5%	3.6	3.5	6.0	5.0	2.5	16.0	0M1	2000
	RCE5C1H560J0M1H03A	C0G	50	56pF	±5%	3.6	3.5	6.0	5.0	2.5	16.0	0M1	2000
	RCE5C1H680J0M1H03A	C0G	50	68pF	±5%	3.6	3.5	6.0	5.0	2.5	16.0	0M1	2000
	RCE5C1H820J0M1H03A	C0G	50	82pF	±5%	3.6	3.5	6.0	5.0	2.5	16.0	0M1	2000
	RCE5C1H101J0M1H03A	C0G	50	100pF	±5%	3.6	3.5	6.0	5.0	2.5	16.0	0M1	2000
	RCE5C1H121J0M1H03A	C0G	50	120pF	±5%	3.6	3.5	6.0	5.0	2.5	16.0	0M1	2000
	RCE5C1H151J0M1H03A	C0G	50	150pF	±5%	3.6	3.5	6.0	5.0	2.5	16.0	0M1	2000
	RCE5C1H181J0M1H03A	C0G	50	180pF	±5%	3.6	3.5	6.0	5.0	2.5	16.0	0M1	2000
	RCE5C1H221J0M1H03A	C0G	50	220pF	±5%	3.6	3.5	6.0	5.0	2.5	16.0	0M1	2000
	RCE5C1H271J0M1H03A	C0G	50	270pF	±5%	3.6	3.5	6.0	5.0	2.5	16.0	0M1	2000
	RCE5C1H331J0M1H03A	C0G	50	330pF	±5%	3.6	3.5	6.0	5.0	2.5	16.0	0M1	2000
	RCE5C1H391J0M1H03A	C0G	50	390pF	±5%	3.6	3.5	6.0	5.0	2.5	16.0	0M1	2000
	RCE5C1H471J0M1H03A	C0G	50	470pF	±5%	3.6	3.5	6.0	5.0	2.5	16.0	0M1	2000
	RCE5C1H561J0M1H03A	C0G	50	560pF	±5%	3.6	3.5	6.0	5.0	2.5	16.0	0M1	2000
	RCE5C1H681J0M1H03A	C0G	50	680pF	±5%	3.6	3.5	6.0	5.0	2.5	16.0	0M1	2000
	RCE5C1H821J0M1H03A	C0G	50	820pF	±5%	3.6	3.5	6.0	5.0	2.5	16.0	0M1	2000
	RCE5C1H102J0M1H03A	C0G	50	1000pF	±5%	3.6	3.5	6.0	5.0	2.5	16.0	0M1	2000
	RCE5C1H122J0M1H03A	C0G	50	1200pF	±5%	3.6	3.5	6.0	5.0	2.5	16.0	0M1	2000
	RCE5C1H152J0M1H03A	C0G	50	1500pF	±5%	3.6	3.5	6.0	5.0	2.5	16.0	0M1	2000
	RCE5C1H182J0M1H03A	C0G	50	1800pF	±5%	3.6	3.5	6.0	5.0	2.5	16.0	0M1	2000
	RCE5C1H222J0M1H03A	C0G	50	2200pF	±5%	3.6	3.5	6.0	5.0	2.5	16.0	0M1	2000
	RCE5C1H272J0M1H03A	C0G	50	2700pF	±5%	3.6	3.5	6.0	5.0	2.5	16.0	0M1	2000
	RCE5C1H332J0M1H03A	C0G	50	3300pF	±5%	3.6	3.5	6.0	5.0	2.5	16.0	0M1	2000
	RCE5C1H392J0M1H03A	C0G	50	3900pF	±5%	3.6	3.5	6.0	5.0	2.5	16.0	0M1	2000
	RCE5C1H472J1M1H03A	C0G	50	4700pF	±5%	4.0	3.5	5.0	5.0	2.5	16.0	1M1	2000
	RCE5C1H562J1M1H03A	C0G	50	5600pF	±5%	4.0	3.5	5.0	5.0	2.5	16.0	1M1	2000
	RCE5C1H682J1M1H03A	C0G	50	6800pF	±5%	4.0	3.5	5.0	5.0	2.5	16.0	1M1	2000
	RCE5C1H822J1M1H03A	C0G	50	8200pF	±5%	4.0	3.5	5.0	5.0	2.5	16.0	1M1	2000
	RCE5C1H103J1M1H03A	C0G	50	10000pF	±5%	4.0	3.5	5.0	5.0	2.5	16.0	1M1	2000
	RCE5C1H123J1M1H03A	C0G	50	12000pF	±5%	4.0	3.5	5.0	5.0	2.5	16.0	1M1	2000
	RCE5C1H153J1M1H03A	C0G	50	15000pF	±5%	4.0	3.5	5.0	5.0	2.5	16.0	1M1	2000
	RCE5C1H183J1M1H03A	C0G	50	18000pF	±5%	4.0	3.5	5.0	5.0	2.5	16.0	1M1	2000
	RCE5C1H223J1M1H03A	C0G	50	22000pF	±5%	4.0	3.5	5.0	5.0	2.5	16.0	1M1	2000
	RCE5C1H273J2M1H03A	C0G	50	27000pF	±5%	5.5	4.0	6.0	5.0	3.15	16.0	2M1	2000
	RCE5C1H333J2M1H03A	C0G	50	33000pF	±5%	5.5	4.0	6.0	5.0	3.15	16.0	2M1	2000
	RCE5C1H393J2M1H03A	C0G	50	39000pF	±5%	5.5	4.0	6.0	5.0	3.15	16.0	2M1	2000
	RCE5C1H473J2M1H03A	C0G	50	47000pF	±5%	5.5	4.0	6.0	5.0	3.15	16.0	2M1	2000
	RCE5C1H563J2M1H03A	C0G	50	56000pF	±5%	5.5	4.0	6.0	5.0	3.15	16.0	2M1	2000
	RCE5C1H683J2M1H03A	C0G	50	68000pF	±5%	5.5	4.0	6.0	5.0	3.15	16.0	2M1	2000

• Inside Crimp Taping
(Lead Style: M*)

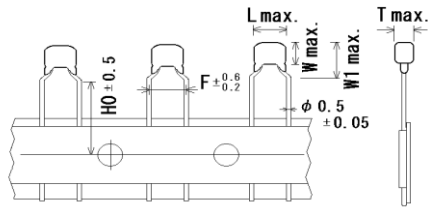

Unit : mm

Customer Part Number	Murata Part Number	T.C.	DC Rated Volt. (V)	Cap.	Cap. Tol.	Dimension (mm)						Dimension (LxW) Lead Style	Pack qty. (pcs)
						L	W	W1	F	T	H/HO		
	RCE5C1H823J2M1H03A	C0G	50	82000pF	±5%	5.5	4.0	6.0	5.0	3.15	16.0	2M1	2000
	RCE5C1H104J2M1H03A	C0G	50	0.1μF	±5%	5.5	4.0	6.0	5.0	3.15	16.0	2M1	2000
	RCE5C2A1R0C0M1H03A	C0G	100	1pF	±0.25pF	3.6	3.5	6.0	5.0	2.5	16.0	0M1	2000
	RCE5C2A2R0C0M1H03A	C0G	100	2pF	±0.25pF	3.6	3.5	6.0	5.0	2.5	16.0	0M1	2000
	RCE5C2A3R0C0M1H03A	C0G	100	3pF	±0.25pF	3.6	3.5	6.0	5.0	2.5	16.0	0M1	2000
	RCE5C2A4R0C0M1H03A	C0G	100	4pF	±0.25pF	3.6	3.5	6.0	5.0	2.5	16.0	0M1	2000
	RCE5C2A5R0C0M1H03A	C0G	100	5pF	±0.25pF	3.6	3.5	6.0	5.0	2.5	16.0	0M1	2000
	RCE5C2A6R0D0M1H03A	C0G	100	6pF	±0.5pF	3.6	3.5	6.0	5.0	2.5	16.0	0M1	2000
	RCE5C2A7R0D0M1H03A	C0G	100	7pF	±0.5pF	3.6	3.5	6.0	5.0	2.5	16.0	0M1	2000
	RCE5C2A8R0D0M1H03A	C0G	100	8pF	±0.5pF	3.6	3.5	6.0	5.0	2.5	16.0	0M1	2000
	RCE5C2A9R0D0M1H03A	C0G	100	9pF	±0.5pF	3.6	3.5	6.0	5.0	2.5	16.0	0M1	2000
	RCE5C2A100J0M1H03A	C0G	100	10pF	±5%	3.6	3.5	6.0	5.0	2.5	16.0	0M1	2000
	RCE5C2A120J0M1H03A	C0G	100	12pF	±5%	3.6	3.5	6.0	5.0	2.5	16.0	0M1	2000
	RCE5C2A150J0M1H03A	C0G	100	15pF	±5%	3.6	3.5	6.0	5.0	2.5	16.0	0M1	2000
	RCE5C2A180J0M1H03A	C0G	100	18pF	±5%	3.6	3.5	6.0	5.0	2.5	16.0	0M1	2000
	RCE5C2A220J0M1H03A	C0G	100	22pF	±5%	3.6	3.5	6.0	5.0	2.5	16.0	0M1	2000
	RCE5C2A270J0M1H03A	C0G	100	27pF	±5%	3.6	3.5	6.0	5.0	2.5	16.0	0M1	2000
	RCE5C2A330J0M1H03A	C0G	100	33pF	±5%	3.6	3.5	6.0	5.0	2.5	16.0	0M1	2000
	RCE5C2A390J0M1H03A	C0G	100	39pF	±5%	3.6	3.5	6.0	5.0	2.5	16.0	0M1	2000
	RCE5C2A470J0M1H03A	C0G	100	47pF	±5%	3.6	3.5	6.0	5.0	2.5	16.0	0M1	2000
	RCE5C2A560J0M1H03A	C0G	100	56pF	±5%	3.6	3.5	6.0	5.0	2.5	16.0	0M1	2000
	RCE5C2A680J0M1H03A	C0G	100	68pF	±5%	3.6	3.5	6.0	5.0	2.5	16.0	0M1	2000
	RCE5C2A820J0M1H03A	C0G	100	82pF	±5%	3.6	3.5	6.0	5.0	2.5	16.0	0M1	2000
	RCE5C2A101J0M1H03A	C0G	100	100pF	±5%	3.6	3.5	6.0	5.0	2.5	16.0	0M1	2000
	RCE5C2A121J0M1H03A	C0G	100	120pF	±5%	3.6	3.5	6.0	5.0	2.5	16.0	0M1	2000
	RCE5C2A151J0M1H03A	C0G	100	150pF	±5%	3.6	3.5	6.0	5.0	2.5	16.0	0M1	2000
	RCE5C2A181J0M1H03A	C0G	100	180pF	±5%	3.6	3.5	6.0	5.0	2.5	16.0	0M1	2000
	RCE5C2A221J0M1H03A	C0G	100	220pF	±5%	3.6	3.5	6.0	5.0	2.5	16.0	0M1	2000
	RCE5C2A271J0M1H03A	C0G	100	270pF	±5%	3.6	3.5	6.0	5.0	2.5	16.0	0M1	2000
	RCE5C2A331J0M1H03A	C0G	100	330pF	±5%	3.6	3.5	6.0	5.0	2.5	16.0	0M1	2000
	RCE5C2A391J0M1H03A	C0G	100	390pF	±5%	3.6	3.5	6.0	5.0	2.5	16.0	0M1	2000
	RCE5C2A471J0M1H03A	C0G	100	470pF	±5%	3.6	3.5	6.0	5.0	2.5	16.0	0M1	2000
	RCE5C2A561J0M1H03A	C0G	100	560pF	±5%	3.6	3.5	6.0	5.0	2.5	16.0	0M1	2000
	RCE5C2A681J0M1H03A	C0G	100	680pF	±5%	3.6	3.5	6.0	5.0	2.5	16.0	0M1	2000
	RCE5C2A821J0M1H03A	C0G	100	820pF	±5%	3.6	3.5	6.0	5.0	2.5	16.0	0M1	2000
	RCE5C2A102J0M1H03A	C0G	100	1000pF	±5%	3.6	3.5	6.0	5.0	2.5	16.0	0M1	2000
	RCE5C2A122J0M1H03A	C0G	100	1200pF	±5%	3.6	3.5	6.0	5.0	2.5	16.0	0M1	2000
	RCE5C2A152J0M1H03A	C0G	100	1500pF	±5%	3.6	3.5	6.0	5.0	2.5	16.0	0M1	2000
	RCE5C2A182J1M1H03A	C0G	100	1800pF	±5%	4.0	3.5	5.0	5.0	2.5	16.0	1M1	2000
	RCE5C2A222J1M1H03A	C0G	100	2200pF	±5%	4.0	3.5	5.0	5.0	2.5	16.0	1M1	2000

• Inside Crimp Taping
(Lead Style: M*)

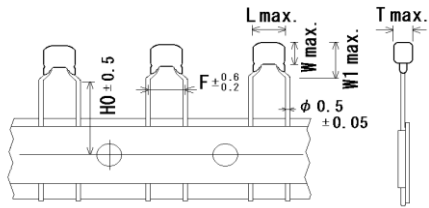

Unit : mm

Customer Part Number	Murata Part Number	T.C.	DC Rated Volt. (V)	Cap.	Cap. Tol.	Dimension (mm)						Dimension (LxW) Lead Style	Pack qty. (pcs)
						L	W	W1	F	T	H/H0		
	RCE5C2A272J1M1H03A	C0G	100	2700pF	±5%	4.0	3.5	5.0	5.0	2.5	16.0	1M1	2000
	RCE5C2A332J1M1H03A	C0G	100	3300pF	±5%	4.0	3.5	5.0	5.0	2.5	16.0	1M1	2000
	RCE5C2A392J2M1H03A	C0G	100	3900pF	±5%	5.5	4.0	6.0	5.0	3.15	16.0	2M1	2000
	RCE5C2A472J2M1H03A	C0G	100	4700pF	±5%	5.5	4.0	6.0	5.0	3.15	16.0	2M1	2000
	RCE5C2A562J2M1H03A	C0G	100	5600pF	±5%	5.5	4.0	6.0	5.0	3.15	16.0	2M1	2000
	RCE5C2A682J2M1H03A	C0G	100	6800pF	±5%	5.5	4.0	6.0	5.0	3.15	16.0	2M1	2000
	RCE5C2A822J2M1H03A	C0G	100	8200pF	±5%	5.5	4.0	6.0	5.0	3.15	16.0	2M1	2000
	RCE5C2A103J2M1H03A	C0G	100	10000pF	±5%	5.5	4.0	6.0	5.0	3.15	16.0	2M1	2000

Reference only

5. AEC-Q200 Murata Standard Specifications and Test Methods																			
No.	AEC-Q200 Test Item	Specification		AEC-Q200 Test Method															
1	Pre-and Post-Stress Electrical Test			-															
2	High Temperature Exposure (Storage)	Appearance	No defects or abnormalities	Sit the capacitor for 1000±12h at 150±3°C. Let sit for 24±2h at *room condition, then measure.															
		Capacitance Change	Within ±3% or ±0.3pF (Whichever is larger)																
		Q	$30\text{pF} \leq C : Q \geq 350$ $10\text{pF} \leq C < 30\text{pF} : Q \geq 275+5C/2$ $10\text{pF} > C : Q \geq 200+10C$ C : Nominal Capacitance (pF)																
		I.R.	More than 1,000MΩ or 50 MΩ·μF (Whichever is smaller)																
3	Temperature Cycling	Appearance	No defects or abnormalities	Perform the 1000 cycles according to the four heat treatments listed in the following table. Let sit for 24±2 h at *room condition, then measure.															
		Capacitance Change	Within ±5% or ±0.5pF (Whichever is larger)																
		Q	$30\text{pF} \leq C : Q \geq 350$ $10\text{pF} \leq C < 30\text{pF} : Q \geq 275+5C/2$ $10\text{pF} > C : Q \geq 200+10C$ C : Nominal Capacitance (pF)																
		I.R.	1,000MΩ or 50MΩ·μF min. (Whichever is smaller)																
<table border="1" style="margin-left: auto; margin-right: auto;"> <thead> <tr> <th>Step</th> <th>1</th> <th>2</th> <th>3</th> <th>4</th> </tr> </thead> <tbody> <tr> <td>Temp. (°C)</td> <td>-55+0/-3</td> <td>Room Temp.</td> <td>125+3/-0</td> <td>Room Temp.</td> </tr> <tr> <td>Time (min.)</td> <td>15±3</td> <td>1</td> <td>15±3</td> <td>1</td> </tr> </tbody> </table>					Step	1	2	3	4	Temp. (°C)	-55+0/-3	Room Temp.	125+3/-0	Room Temp.	Time (min.)	15±3	1	15±3	1
Step	1	2	3	4															
Temp. (°C)	-55+0/-3	Room Temp.	125+3/-0	Room Temp.															
Time (min.)	15±3	1	15±3	1															
4	Moisture Resistance	Appearance	No defects or abnormalities	Apply the 24h heat (25 to 65°C) and humidity (80 to 98%) treatment shown below, 10 consecutive times. Let sit for 24±2 h at *room condition, then measure.															
		Capacitance Change	Within ±5% or ± 0.5pF (Whichever is larger)																
		Q	$30\text{pF} \leq C : Q \geq 200$ $30\text{pF} > C : Q \geq 100+10C/3$ C : Nominal Capacitance (pF)																
		I.R.	500MΩ or 25MΩ·μF min. (Whichever is smaller)																
5	Biased Humidity	Appearance	No defects or abnormalities	Apply the rated voltage and DC1.3+0.2/-0V (add 100kΩ resistor) at 85±3°C and 80 to 85% humidity for 1,000±12h. Remove and let sit for 24±2 h at *room condition, then measure. The charge/discharge current is less than 50mA.															
		Capacitance Change	Within ±5% or ± 0.5pF (Whichever is larger)																
		Q	$30\text{pF} \leq C : Q \geq 200$ $30\text{pF} > C : Q \geq 100+10C/3$ C : Nominal Capacitance (pF)																
		I.R.	500MΩ or 25MΩ·μF min. (Whichever is smaller)																
6	Operational Life	Appearance	No defects or abnormalities	Apply 200% of the rated voltage for 1000±12h at 125±3°C. Let sit for 24±2 h at *room condition, then measure. The charge/discharge current is less than 50mA.															
		Capacitance Change	Within ±3% or ±0.3pF (Whichever is larger)																
		Q	$30\text{pF} \leq C : Q \geq 350$ $10\text{pF} \leq C < 30\text{pF} : Q \geq 275+5C/2$ $10\text{pF} > C : Q \geq 200+10C$ C : Nominal Capacitance (pF)																
		I.R.	1,000MΩ or 50MΩ·μF min. (Whichever is smaller)																

* "room condition" Temperature : 15 to 35°C, Relative humidity : 45 to 75%, Atmosphere pressure : 86 to 106kPa

Reference only

No.	AEC-Q200 Test Item	Specification	AEC-Q200 Test Method
7	External Visual	No defects or abnormalities.	Visual inspection.
8	Physical Dimension	Within the specified dimensions.	Using calipers and micrometers.
9	Marking	To be easily legible.	Visual inspection.
10	Resistance to Solvents	Appearance	No defects or abnormalities.
		Capacitance	Within the specified tolerance.
		Q	$30\text{pF} \leq C : Q \geq 1,000$ $30\text{pF} > C : Q \geq 400+20C$ C : Nominal Capacitance (pF)
		I.R.	More than 10,000MΩ or 500 MΩ·μF (Whichever is smaller)
11	Mechanical Shock	Appearance	No defects or abnormalities.
		Capacitance	Within the specified tolerance.
		Q	$30\text{pF} \leq C : Q \geq 1,000$ $30\text{pF} > C : Q \geq 400+20C$ C : Nominal Capacitance (pF)
			Three shocks in each direction should be applied along 3 mutually perpendicular axes of the test specimen (18 shocks). The specified test pulse should be Half-sine and should have a duration : 0.5ms, peak value : 1500G and velocity change : 4.7m/s.
12	Vibration	Appearance	No defects or abnormalities.
		Capacitance	Within the specified tolerance.
		Q	$30\text{pF} \leq C : Q \geq 1,000$ $30\text{pF} > C : Q \geq 400+20C$ C : Nominal Capacitance (pF)
			The capacitor should be subjected to a simple harmonic motion having a total amplitude of 1.5mm, the frequency being varied uniformly between the approximate limits of 10 and 2,000Hz. The frequency range, from 10 to 2000Hz and return to 10Hz, should be traversed in approximately 20 min. This motion should be applied for 12 items in each 3 mutually perpendicular directions (total of 36 times).
13-1	Resistance to Soldering Heat (Non-Preheat)	Appearance	No defects or abnormalities.
		Capacitance	Within $\pm 2.5\%$ or $\pm 0.25\text{pF}$
		Change	(Whichever is larger)
		Dielectric Strength (Between terminals)	No defects.
			The lead wires should be immersed in the melted solder 1.5 to 2.0mm from the root of terminal at $260\pm 5^\circ\text{C}$ for 10 ± 1 seconds. • Post-treatment Capacitor should be stored for 24 ± 2 hours at *room condition.
13-2	Resistance to Soldering Heat (On-Preheat)	Appearance	No defects or abnormalities.
		Capacitance	Within $\pm 2.5\%$ or $\pm 0.25\text{pF}$
		Change	(Whichever is larger)
		Dielectric Strength (Between terminals)	No defects
			First the capacitor should be stored at $120+0/-5^\circ\text{C}$ for $60+0/-5$ seconds. Then, the lead wires should be immersed in the melted solder 1.5 to 2.0mm from the root of terminal at $260\pm 5^\circ\text{C}$ for $7.5+0/-1$ seconds. • Post-treatment Capacitor should be stored for 24 ± 2 hours at *room condition.
13-3	Resistance to Soldering Heat (soldering iron method)	Appearance	No defects or abnormalities.
		Capacitance	Within $\pm 2.5\%$ or $\pm 0.25\text{pF}$
		Change	(Whichever is larger)
		Dielectric Strength (Between terminals)	No defects
			Test condition Temperature of iron-tip : $350\pm 10^\circ\text{C}$ Soldering time : 3.5 ± 0.5 seconds Soldering position Straight Lead : 1.5 to 2.0mm from the root of terminal. Crimp Lead : 1.5 to 2.0mm from the end of lead bend. • Post-treatment Capacitor should be stored for 24 ± 2 hours at *room condition.
14	Thermal Shock	Appearance	No defects or abnormalities.
		Capacitance	Within $\pm 5\%$ or $\pm 0.5\text{pF}$
		Change	(Whichever is larger)
		Q	$30\text{pF} \leq C : Q \geq 350$ $10\text{pF} \leq C < 30\text{pF} : Q \geq 275+5C/2$ $10\text{pF} > C : Q \geq 200+10C$ C : Nominal Capacitance (pF)
		I.R.	1,000MΩ or 50MΩ·μF min. (Whichever is smaller)
			Perform the 300 cycles according to the two heat treatments listed in the following table (Maximum transfer time is 20s.). Let sit for 24 ± 2 h at *room condition, then measure.

Step	1	2
Temp. (°C)	-55+0/-3	125+3/-0
Time (min.)	15±3	15±3

* "room condition" Temperature : 15 to 35°C, Relative humidity : 45 to 75%, Atmosphere pressure : 86 to 106kPa

Reference only

No.	AEC-Q200 Test Item		Specifications	AEC-Q200 Test Method											
15	ESD	Appearance	No defects or abnormalities.	Per AEC-Q200-002											
		Capacitance	Within the specified tolerance.												
		Q	$30\text{pF} \leq C : Q \geq 1,000$ $30\text{pF} > C : Q \geq 400+20C$ C : Nominal Capacitance (pF)												
		I.R.	More than 10,000M Ω or 500 M Ω · μF (Whichever is smaller)												
16	Solderability	Lead wire should be soldered with uniform coating on the axial direction over 95% of the circumferential direction.	Should be placed into steam aging for 8h \pm 15 min. The terminal of capacitor is dipped into a solution of ethanol (JIS K 8101) and rosin (JIS K 5902) (25% rosin in weight propotion). Immerse in solder solution for 2 \pm 0.5 seconds. In both cases the depth of dipping is up to about 1.5 to 2mm from the terminal body. Temp. of solder : 245 \pm 5 $^{\circ}\text{C}$ Lead Free Solder (Sn-3.0Ag-0.5Cu) 235 \pm 5 $^{\circ}\text{C}$ H60A or H63A Eutectic Solder												
17	Electrical Characterization	Appearance	No defects or abnormalities.	Visual inspection.											
		Capacitance	Within the specified tolerance.	The capacitance, Q should be measured at 25 $^{\circ}\text{C}$ at the frequency and voltage shown in the table.											
		Q	$30\text{pF} \leq C : Q \geq 1,000$ $30\text{pF} > C : Q \geq 400+20C$ C : Nominal Capacitance (pF)												
		I.R.	Between Terminals	10,000M Ω or 500M Ω · μF min. (Whichever is smaller)	The insulation resistance should be measured with a DC voltage not exceeding the rated voltage at 25 $^{\circ}\text{C}$ within 2 min. of charging.										
		Dielectric Strength	Between Terminals	No defects or abnormalities.	The capacitor should not be damaged when DC voltage of 300% of the rated voltage is applied between the terminations for 1 to 5 seconds. (Charge/Discharge current \leq 50mA.)										
Body Insulation	No defects or abnormalities.		The capacitor is placed in a container with metal balls of 1mm diameter so that each terminal, short-circuit is kept approximately 2mm from the balls, and 250% of the rated DC voltage is impressed for 1 to 5 seconds between capacitor terminals and metal balls. (Charge/Discharge current \leq 50mA.)												
18	Terminal Strength	Tensile Strength	Termination not to be broken or loosened.	As in the figure, fix the capacitor body, apply the force gradually to each lead in the radial direction of the capacitor until reaching 10N and then keep the force applied for 10 \pm 1 seconds. 											
		Bending Strength	Termination not to be broken or loosened.	Each lead wire should be subjected to a force of 2.5N and then be bent 90 $^{\circ}$ at the point of egress in one direction. Each wire is then returned to the original position and bent 90 $^{\circ}$ in the opposite direction at the rate of one bend per 2 to 3 seconds.											
19	Capacitance Temperature Characteristics	Within the specified Tolerance 25 $^{\circ}\text{C}$ to 125 $^{\circ}\text{C}$: 0 \pm 30ppm/ $^{\circ}\text{C}$ -55 $^{\circ}\text{C}$ to 25 $^{\circ}\text{C}$: 0+30/-72ppm/ $^{\circ}\text{C}$	The capacitance change should be measured after 5min. at each specified temperature step. <table border="1" data-bbox="1002 1630 1281 1814"> <thead> <tr> <th>Step</th> <th>Temperature($^{\circ}\text{C}$)</th> </tr> </thead> <tbody> <tr> <td>1</td> <td>25\pm2</td> </tr> <tr> <td>2</td> <td>-55\pm3</td> </tr> <tr> <td>3</td> <td>25\pm2</td> </tr> <tr> <td>4</td> <td>125\pm3</td> </tr> <tr> <td>5</td> <td>25\pm2</td> </tr> </tbody> </table> The temperature coefficient is determined using the capacitance measured in step 3 as a reference. When cycling the temperature sequentially from step 1 through 5 (-55 $^{\circ}\text{C}$ to 125 $^{\circ}\text{C}$) the capacitance should be within the specified tolerance for the temperature coefficient and capacitance change as Table A. The capacitance drift is calculated by dividing the differences between the maximum and minimum measured values in the step 1, 3 and 5 by the capacitance value in step 3.	Step	Temperature($^{\circ}\text{C}$)	1	25 \pm 2	2	-55 \pm 3	3	25 \pm 2	4	125 \pm 3	5	25 \pm 2
Step	Temperature($^{\circ}\text{C}$)														
1	25 \pm 2														
2	-55 \pm 3														
3	25 \pm 2														
4	125 \pm 3														
5	25 \pm 2														

* "room condition" Temperature : 15 to 35 $^{\circ}\text{C}$, Relative humidity : 45 to 75%, Atmosphere pressure : 86 to 106kPa

ESRCE02C

6. Packing specification

•Bulk type (Packing style code : B)

The size of packing case and packing way

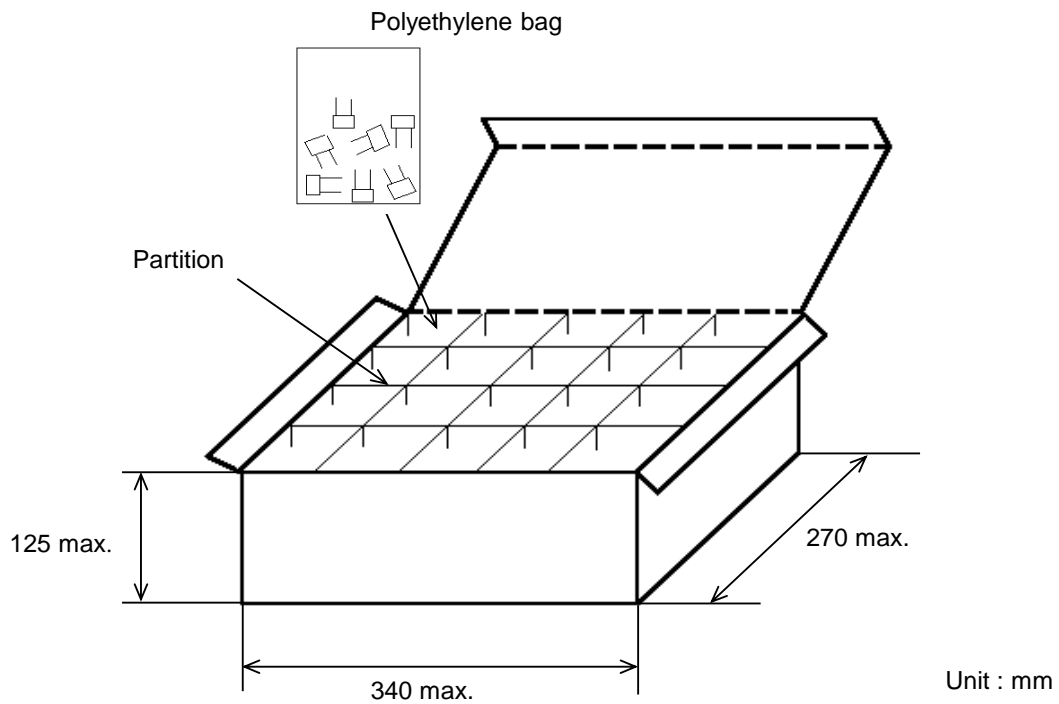

The number of packing = ^{*1} Packing quantity × ^{*2} n

*1 : Please refer to [Part number list].

*2 : Standard n = 20 (bag)

Note)

The outer package and the number of outer packing be changed by the order getting amount.

• Ammo pack taping type (Packing style code : A)

A crease is made every 25 pitches, and the tape with capacitors is packed zigzag into a case. When body of the capacitor is piled on other body under it.

The size of packing case and packing way

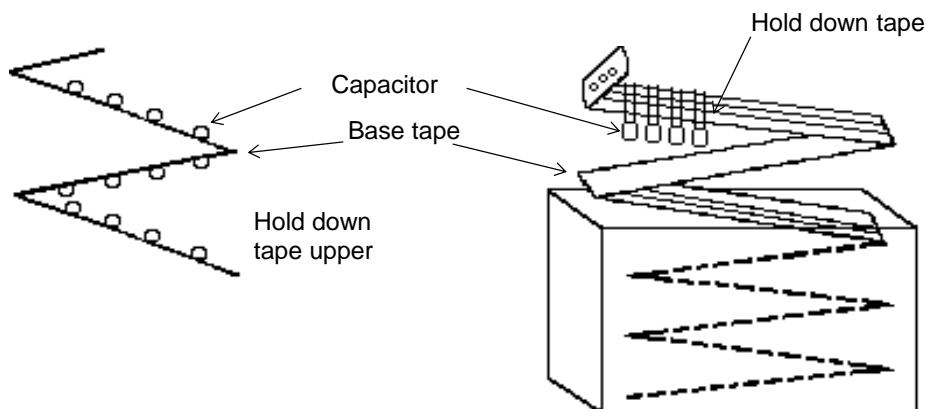
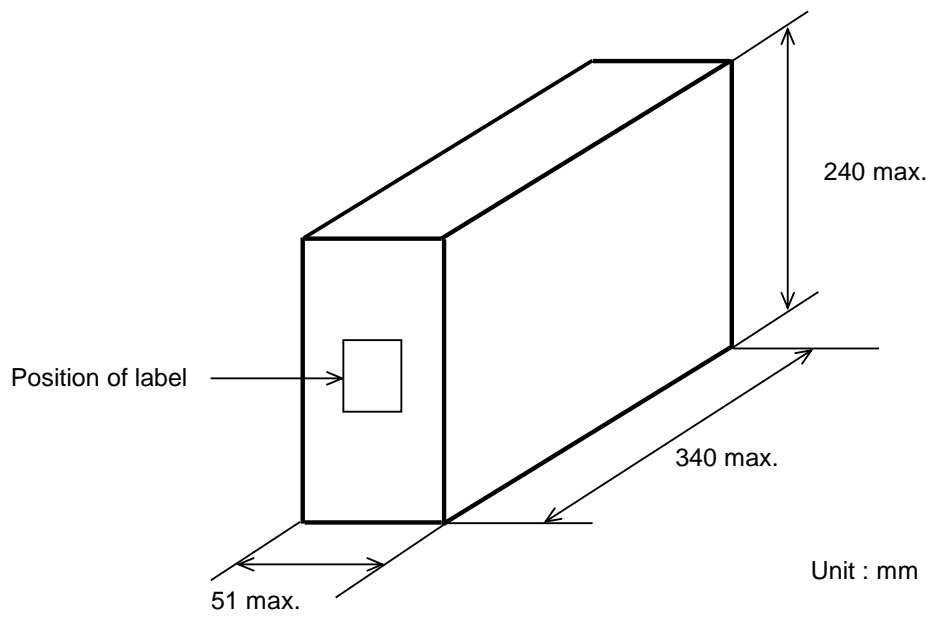

7. Taping specification

7-1. Dimension of capacitors on tape

Straight taping type < Lead code : DB >

Pitch of component 12.7mm / Lead spacing 2.5mm

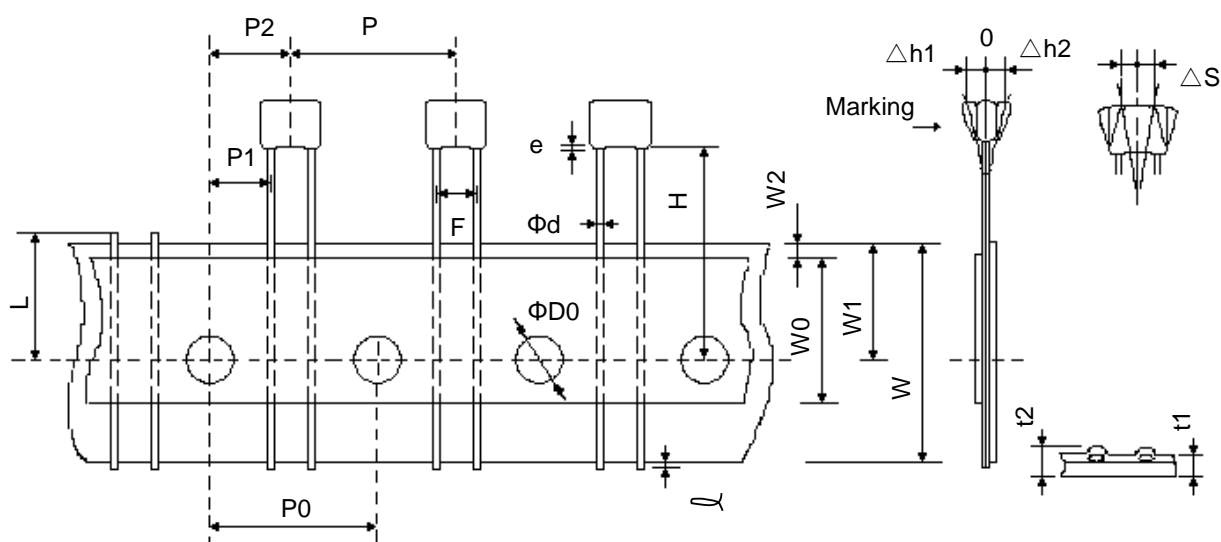

Unit : mm

Item	Code	Dimensions	Remarks
Pitch of component	P	12.7+/-1.0	
Pitch of sprocket hole	P0	12.7+/-0.2	
Lead spacing	F	2.5+0.4/-0.2	
Length from hole center to component center	P2	6.35+/-1.3	Deviation of progress direction
Length from hole center to lead	P1	5.1+/-0.7	
Deviation along tape, left or right defect	ΔS	0+/-2.0	They include deviation by lead bend
Carrier tape width	W	18.0+/-0.5	
Position of sprocket hole	W1	9.0+0/-0.5	Deviation of tape width direction
Lead distance between reference and bottom plane	H	16.0+/-0.5	
Protrusion length	l	0.5 max.	
Diameter of sprocket hole	ΦD0	4.0+/-0.1	
Lead diameter	Φd	0.5+/-0.05	
Total tape thickness	t1	0.6+/-0.3	They include hold down tape thickness
Total thickness of tape and lead wire	t2	1.5 max.	
Deviation across tape	Δh1	1.0 max.	
	Δh2		
Portion to cut in case of defect	L	11.0+0/-1.0	
Hold down tape width	W0	9.5 min.	
Hold down tape position	W2	1.5+/-1.5	
Coating extension on lead	e	1.5 max.	

Inside crimp taping type < Lead code : M1 >
Pitch of component 12.7mm / Lead spacing 5.0mm

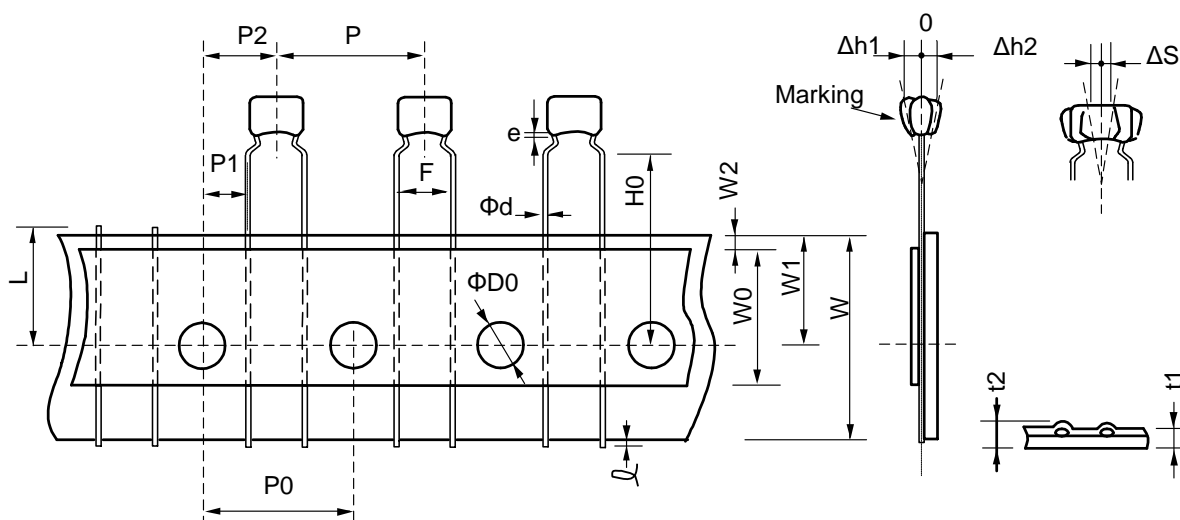

Unit : mm

Item	Code	Dimensions	Remarks
Pitch of component	P	12.7+/-1.0	
Pitch of sprocket hole	P0	12.7+/-0.2	
Lead spacing	F	5.0+0.6/-0.2	
Length from hole center to component center	P2	6.35+/-1.3	Deviation of progress direction
Length from hole center to lead	P1	3.85+/-0.7	
Deviation along tape, left or right defect	ΔS	0+/-2.0	They include deviation by lead bend
Carrier tape width	W	18.0+/-0.5	
Position of sprocket hole	W1	9.0+0/-0.5	Deviation of tape width direction
Lead distance between reference and bottom plane	H0	16.0+/-0.5	
Protrusion length	ℓ	0.5 max.	
Diameter of sprocket hole	ΦD0	4.0+/-0.1	
Lead diameter	Φd	0.5+/-0.05	
Total tape thickness	t1	0.6+/-0.3	They include hold down tape thickness
Total thickness of tape and lead wire	t2	1.5 max.	
Deviation across tape	Δh1	2.0 max. (Dimension code : W)	
	Δh2	1.0 max. (except as above)	
Portion to cut in case of defect	L	11.0+0/-1.0	
Hold down tape width	W0	9.5 min.	
Hold down tape position	W2	1.5+/-1.5	
Coating extension on lead	e	Up to the end of crimp	

7-2. Splicing way of tape

1) Adhesive force of tape is over 3N at test condition as below.

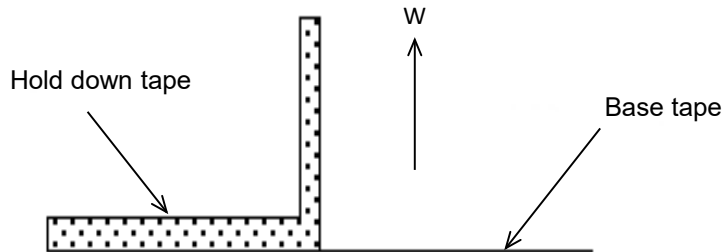

2) Splicing of tape

a) When base tape is spliced

- Base tape shall be spliced by cellophane tape.
(Total tape thickness shall be less than 1.05mm.)

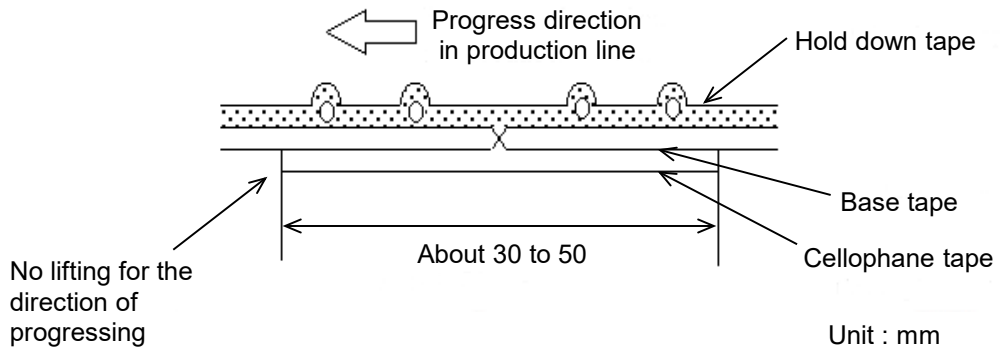

b) When hold down tape is spliced

- Hold down tape shall be spliced with overlapping.
(Total tape thickness shall be less than 1.05mm.)

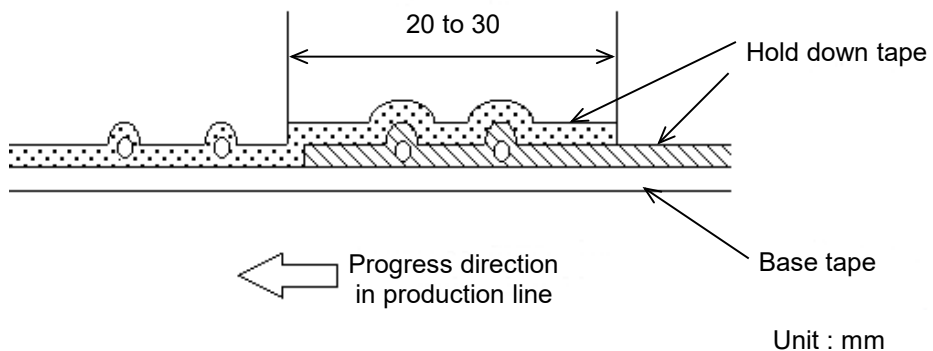

c) When both tape are spliced

- Base tape and hold down tape shall be spliced with splicing tape.

X-ON Electronics

Largest Supplier of Electrical and Electronic Components

Click to view similar products for [Multilayer Ceramic Capacitors MLCC - Leaded](#) category:

Click to view products by [Murata](#) manufacturer:

Other Similar products are found below :

[010-007220-002REV A](#) [M39014/01-1210V](#) [M39014/01-1281V](#) [M39014/01-1284V](#) [M39014/01-1308VTR1](#) [M39014/01-1311TR1](#)
[M39014/01-1313V](#) [M39014/01-1351TR1](#) [M39014/01-1354V](#) [M39014/01-1580V](#) [M39014/01-1593](#) [M39014/02-1300V](#) [M39014/02-1350](#)
[M39014/02-1356VTR1](#) [M39014/05-2103](#) [M39014/05-2105](#) [M39014/05-2127](#) [M39014/05-2736](#) [M39014/22-1097](#) [Q52-DK](#)
[AR215F103K4RTR2-3323](#) [C420C102J1G5TATR](#) [C430C104M1U5TATR](#) [SL155C222MAB](#) [CCR06CG183FM](#) [M39014/01-1320V](#)
[M39014/01-1321V](#) [M39014/01-1345V](#) [M39014/01-1351V](#) [M39014/011523](#) [M39014/01-1526V](#) [M39014/01-1528V](#) [M39014/02-1222V](#)
[M39014/021292](#) [M39014/02-1302V](#) [M39014/021356](#) [M39014/02-1360VTR1](#) [M39014/05-2910](#) [M39014/22-0975](#) [MD015A103KAB](#) [88011-](#)
[154 RF](#) [CCR09CG121JR](#) [CCR06CG183FS](#) [5GAT47](#) [TKC-TMC1206-05-1501-J??](#) [TKC-TMC1206-05-1801-J](#) [TKC-TMC1206-05-44R2-F](#)
[TKC-TMC1206-05-4703-J??](#) [TKC-TMC2512-05-1211-F](#) [100B330JT500XT5](#)