



Reference Specification

Leaded MLCC for General Purpose
RDE Series

Product specifications in this catalog are as of Dec. 2017, and are subject to change or obsolescence without notice.
Please consult the approval sheet before ordering. Please read rating and Cautions first.

Reference only

⚠ CAUTION

1. OPERATING VOLTAGE

When DC-rated capacitors are to be used in AC or ripple current circuits, be sure to maintain the V_{p-p} value of the applied voltage or the V_{o-p} which contains DC bias within the rated voltage range. When the voltage is started to apply to the circuit or it is stopped applying, the irregular voltage may be generated for a transit period because of resonance or switching. Be sure to use a capacitor within rated voltage containing these irregular voltage.

When DC-rated capacitors are to be used in input circuits from commercial power source (AC filter), be sure to use Safety Recognized Capacitors because various regulations on withstand voltage or impulse withstand established for each equipment should be taken into considerations.

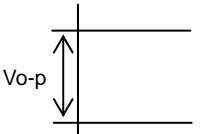
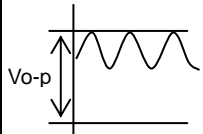
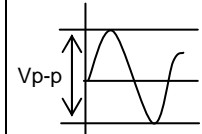
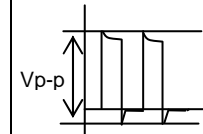
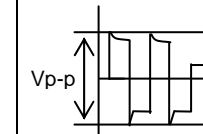
Voltage	DC Voltage	DC+AC Voltage	AC Voltage	Pulse Voltage(1)	Pulse Voltage(2)
Positional Measurement					

2. OPERATING TEMPERATURE AND SELF-GENERATED HEAT

Keep the surface temperature of a capacitor below the upper limit of its rated operating temperature range. Be sure to take into account the heat generated by the capacitor itself.

When the capacitor is used in a high-frequency current, pulse current or the like, it may have the self-generated heat due to dielectric-loss. In case of Class 2 capacitors (Temp.Char. : X7R,X7S,X8L, etc.), applied voltage should be the load such as self-generated heat is within 20 °C on the condition of atmosphere temperature 25 °C. Please contact us if self-generated heat is occurred with Class 1 capacitors (Temp.Char. : C0G,U2J,X8G, etc.). When measuring, use a thermocouple of small thermal capacity-K of $\phi 0.1$ mm and be in the condition where capacitor is not affected by radiant heat of other components and wind of surroundings. Excessive heat may lead to deterioration of the capacitor's characteristics and reliability.

3. Fail-safe

Be sure to provide an appropriate fail-safe function on your product to prevent a second damage that may be caused by the abnormal function or the failure of our product.

4. OPERATING AND STORAGE ENVIRONMENT

The insulating coating of capacitors does not form a perfect seal; therefore, do not use or store capacitors in a corrosive atmosphere, especially where chloride gas, sulfide gas, acid, alkali, salt or the like are present. And avoid exposure to moisture. Before cleaning, bonding, or molding this product, verify that these processes do not affect product quality by testing the performance of a cleaned, bonded or molded product in the intended equipment. Store the capacitors where the temperature and relative humidity do not exceed 5 to 40 °C and 20 to 70%. Use capacitors within 6 months.

5. VIBRATION AND IMPACT

Do not expose a capacitor or its leads to excessive shock or vibration during use.

6. SOLDERING

When soldering this product to a PCB/PWB, do not exceed the solder heat resistance specification of the capacitor. Subjecting this product to excessive heating could melt the internal junction solder and may result in thermal shocks that can crack the ceramic element.

7. BONDING AND RESIN MOLDING, RESIN COAT

In case of bonding, molding or coating this product, verify that these processes do not affect the quality of capacitor by testing the performance of a bonded or molded product in the intended equipment.

In case of the amount of applications, dryness / hardening conditions of adhesives and molding resins containing organic solvents (ethyl acetate, methyl ethyl ketone, toluene, etc.) are unsuitable, the outer coating resin of a capacitor is damaged by the organic solvents and it may result, worst case, in a short circuit.

The variation in thickness of adhesive or molding resin may cause a outer coating resin cracking and/or ceramic element cracking of a capacitor in a temperature cycling.

8. TREATMENT AFTER BONDING AND RESIN MOLDING, RESIN COAT

When the outer coating is hot (over 100 °C) after soldering, it becomes soft and fragile.

So please be careful not to give it mechanical stress.

Reference only

Failure to follow the above cautions may result, worst case, in a short circuit and cause fuming or partial dispersion when the product is used.

9. LIMITATION OF APPLICATIONS

Please contact us before using our products for the applications listed below which require especially high reliability for the prevention of defects which might directly cause damage to the third party's life, body or property.

1. Aircraft equipment
2. Aerospace equipment
3. Undersea equipment
4. Power plant control equipment
5. Medical equipment
6. Transportation equipment (vehicles, trains, ships, etc.)
7. Traffic signal equipment
8. Disaster prevention / crime prevention equipment
9. Data-processing equipment exerting influence on public
10. Application of similar complexity and/or reliability requirements to the applications listed in the above.

NOTICE

1. CLEANING (ULTRASONIC CLEANING)

To perform ultrasonic cleaning, observe the following conditions.

Rinse bath capacity : Output of 20 watts per liter or less.

Rinsing time : 5 min maximum.

Do not vibrate the PCB/PWB directly.

Excessive ultrasonic cleaning may lead to fatigue destruction of the lead wires.

2. Soldering and Mounting

Insertion of the Lead Wire

- When soldering, insert the lead wire into the PCB without mechanically stressing the lead wire.
- Insert the lead wire into the PCB with a distance appropriate to the lead space.

3. CAPACITANCE CHANGE OF CAPACITORS

- Class 2 capacitors (Temp.Char. : X7R,X7S,X8L, etc.)

Class 2 capacitors an aging characteristic, whereby the capacitor continually decreases its capacitance slightly if the capacitor leaves for a long time. Moreover, capacitance might change greatly depending on a surrounding temperature or an applied voltage. So, it is not likely to be able to use for the time constant circuit.

Please contact us if you need a detail information.

NOTE

1. Please make sure that your product has been evaluated in view of your specifications with our product being mounted to your product.
2. You are requested not to use our product deviating from this specification.

Reference only

1. Application

This product specification is applied to Leaded MLCC RDE series used for General Electronic equipment. Do not use these products in any automotive power train or safety equipment including battery chargers for electric vehicles and plug-in hybrids.

2. Rating

- Part number configuration

ex.)	RDE	F5	1H	103	Z	0	K1	H03	B
	Series	Temperature Characteristic	Rated voltage	Capacitance	Capacitance tolerance	Dimension code	Lead code	Individual specification code	Packing style code

- Temperature characteristic

Code	Temp. Char.	Temp. Range	Cap. Change (Within%)	Standard Temp.	Operating Temp. Range
F5	Y5V	-30~85°C	+22/-82	25°C	-30~85°C

- Rated voltage

Code	Rated voltage
1H	DC50V

- Capacitance

The first two digits denote significant figures ; the last digit denotes the multiplier of 10 in pF.
ex.) In case of 103.

$$10 \times 10^3 = 10000 \text{pF}$$

- Capacitance tolerance

Code	Capacitance Tolerance
Z	+80/-20%

- Dimension code

Code	Dimensions (LxW) mm max.
0	4.0 x 3.5 (Lead code : K1, M1)
	5.0 x 3.5 (Lead code : P1, S1)

- Lead code

Code	Lead style	Lead spacing (mm)
K1	Inside crimp type	5.0+/-0.8
M1	Inside crimp taping type	5.0+0.6/-0.2
P1	Outside crimp type	2.5+/-0.8
S1	Outside crimp taping type	2.5+0.4/-0.2

Lead wire is solder coated CP wire.

Reference only

- Individual specification code
Murata's control code
Please refer to [Part number list].

- Packing style code

Code	Packing style
A	Taping type of Ammo
B	Bulk type

3. Marking

Capacitance : 3 digit numbers

Capacitance tolerance : Code

Dimension code	Ex.
0	

Reference only

4. Part number list

• Outside Crimp
(Lead Code:P1)

• Inside Crimp
(Lead Code:K1)

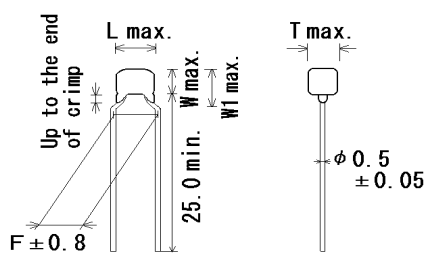
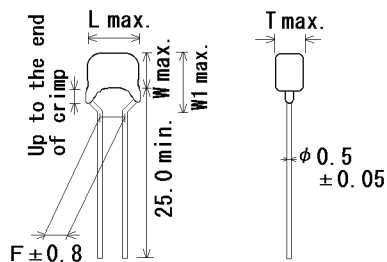

Unit : mm

Customer Part Number	Murata Part Number	T.C.	DC Rated Volt. (V)	Cap.	Cap. tol.	Dimension (mm)					Size Lead Code	Pack qty. (pcs)
						L	W	W1	F	T		
	RDEF51H103Z0P1H03B	Y5V	50	10000pF	+80/-20%	5.0	3.5	6.0	2.5	2.5	0P1	500
	RDEF51H223Z0P1H03B	Y5V	50	22000pF	+80/-20%	5.0	3.5	6.0	2.5	2.5	0P1	500
	RDEF51H473Z0P1H03B	Y5V	50	47000pF	+80/-20%	5.0	3.5	6.0	2.5	2.5	0P1	500
	RDEF51H104Z0P1H03B	Y5V	50	0.10μF	+80/-20%	5.0	3.5	6.0	2.5	2.5	0P1	500
	RDEF51H103Z0K1H03B	Y5V	50	10000pF	+80/-20%	4.0	3.5	6.0	5.0	2.5	0K1	500
	RDEF51H223Z0K1H03B	Y5V	50	22000pF	+80/-20%	4.0	3.5	6.0	5.0	2.5	0K1	500
	RDEF51H473Z0K1H03B	Y5V	50	47000pF	+80/-20%	4.0	3.5	6.0	5.0	2.5	0K1	500
	RDEF51H104Z0K1H03B	Y5V	50	0.10μF	+80/-20%	4.0	3.5	6.0	5.0	2.5	0K1	500

Reference only

• Outside Crimp Taping
(Lead Code: S*)

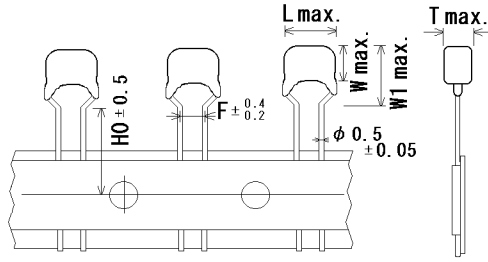

• Inside Crimp Taping
(Lead Code: M*)

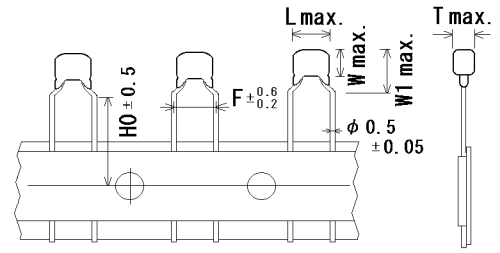

Unit : mm

Customer Part Number	Murata Part Number	T.C.	DC Rated volt. (V)	Cap.	Cap. tol.	Dimension (mm)						Size Lead Code	Pack qty. (pcs)
						L	W	W1	F	T	H0		
	RDEF51H103Z0S1H03A	Y5V	50	10000pF	+80/-20%	5.0	3.5	6.0	2.5	2.5	16.0	0S1	2000
	RDEF51H223Z0S1H03A	Y5V	50	22000pF	+80/-20%	5.0	3.5	6.0	2.5	2.5	16.0	0S1	2000
	RDEF51H473Z0S1H03A	Y5V	50	47000pF	+80/-20%	5.0	3.5	6.0	2.5	2.5	16.0	0S1	2000
	RDEF51H104Z0S1H03A	Y5V	50	0.10μF	+80/-20%	5.0	3.5	6.0	2.5	2.5	16.0	0S1	2000
	RDEF51H103Z0M1H03A	Y5V	50	10000pF	+80/-20%	4.0	3.5	6.0	5.0	2.5	16.0	0M1	2000
	RDEF51H223Z0M1H03A	Y5V	50	22000pF	+80/-20%	4.0	3.5	6.0	5.0	2.5	16.0	0M1	2000
	RDEF51H473Z0M1H03A	Y5V	50	47000pF	+80/-20%	4.0	3.5	6.0	5.0	2.5	16.0	0M1	2000
	RDEF51H104Z0M1H03A	Y5V	50	0.10μF	+80/-20%	4.0	3.5	6.0	5.0	2.5	16.0	0M1	2000

Reference only

5.SPECIFICATIONS AND TEST METHODS

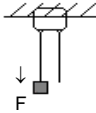
No.	Item	Specification	Test Method												
1	Appearance	No defects or abnormalities	Visual inspection.												
2	Dimension and Marking	Within the specified dimensions and Marking	Visual inspection, Using Caliper.												
3	Dielectric Strength	Between Terminals	No defects or abnormalities	The capacitor should not be damaged when DC voltage of 250% of the rated voltage is applied between the terminations for 1 to 5 seconds. (Charge/Discharge current \leq 50mA.)											
		Body Insulation	No defects or abnormalities	The capacitor is placed in a container with metal balls of 1mm diameter so that each terminal, short-circuit, is kept approximately 2mm from the balls, and 250% of the rated DC voltage is impressed for 1 to 5 seconds between capacitor terminals and metal balls. (Charge/Discharge current \leq 50mA.)											
4	Insulation Resistance (I.R.)	Between Terminals	10,000M Ω or 500M Ω · μ F min. (Whichever is smaller)	The insulation resistance should be measured with a DC voltage not exceeding the rated voltage at normal temperature and humidity and within 2 minutes of charging. (Charge/Discharge current \leq 50mA)											
5	Capacitance	Within the specified tolerance	The capacitance, D.F. should be measured at 25°C at the frequency and voltage shown in the table.												
6	Dissipation Factor (D.F.)	Y5V : 0.05 max.	<table border="1" style="display: inline-table; border-collapse: collapse;"> <tr> <td style="text-align: center;">Char. Item</td> <td style="text-align: center;">Y5V</td> </tr> <tr> <td style="text-align: center;">Frequency</td> <td style="text-align: center;">1\pm0.1kHz</td> </tr> <tr> <td style="text-align: center;">Voltage</td> <td style="text-align: center;">AC1\pm0.2V(rms)</td> </tr> </table>	Char. Item	Y5V	Frequency	1 \pm 0.1kHz	Voltage	AC1 \pm 0.2V(rms)						
Char. Item	Y5V														
Frequency	1 \pm 0.1kHz														
Voltage	AC1 \pm 0.2V(rms)														
7	Capacitance Temperature Characteristics	Y5V : within +22/-82%	<p>The capacitance change should be measured after 5 min. at each specified temperature stage.</p> <p>The ranges of capacitance change compared with the 25°C value over the temperature ranges shown in the table should be within the specified ranges.</p> <table border="1" style="margin-left: auto; margin-right: auto; border-collapse: collapse;"> <thead> <tr> <th>Step</th> <th>Temperature(°C)</th> </tr> </thead> <tbody> <tr> <td style="text-align: center;">1</td> <td style="text-align: center;">25\pm2</td> </tr> <tr> <td style="text-align: center;">2</td> <td style="text-align: center;">-30\pm3</td> </tr> <tr> <td style="text-align: center;">3</td> <td style="text-align: center;">25\pm2</td> </tr> <tr> <td style="text-align: center;">4</td> <td style="text-align: center;">85\pm3</td> </tr> <tr> <td style="text-align: center;">5</td> <td style="text-align: center;">25\pm2</td> </tr> </tbody> </table> <p>• Pretreatment Perform a heat treatment at 150+0/-10°C for one hour and then set at *room condition for 24\pm2 hours.</p>	Step	Temperature(°C)	1	25 \pm 2	2	-30 \pm 3	3	25 \pm 2	4	85 \pm 3	5	25 \pm 2
Step	Temperature(°C)														
1	25 \pm 2														
2	-30 \pm 3														
3	25 \pm 2														
4	85 \pm 3														
5	25 \pm 2														
8	Terminal Strength	Tensile Strength	Termination not to be broken or loosened	<p>As in the figure, fix the capacitor body, apply the force gradually to each lead in the radial direction of the capacitor until reaching 10N and then keep the force applied for 10\pm1 seconds.</p> 											
		Bending Strength	Termination not to be broken or loosened	Each lead wire should be subjected to a force of 2.5N and then be bent 90° at the point of egress in one direction. Each wire is then returned to the original position and bent 90° in the opposite direction at the rate of one bend per 2 to 3 seconds.											
9	Vibration Resistance	Appearance	No defects or abnormalities	<p>The capacitor should be subjected to a simple harmonic motion having a total amplitude of 1.5mm, the frequency being varied uniformly between the approximate limits of 10Hz and 55Hz. The frequency range, from 10Hz to 55Hz and return to 10Hz, shall be traversed in approximately 1 minute. This motion shall be applied for a period of 2 hours in each 3 mutually perpendicular directions (total of 6 hours).</p>											
		Capacitance	Within the specified tolerance												
		D.F.	Y5V : 0.05 max.												

* "room condition" Temperature:15 to 35°C, Relative humidity:45 to 75%, Atmosphere pressure:86 to 106kPa

Reference only

No.	Item	Specification	Test Method															
10	Solderability of Lead	Solder is deposited on unintermittently immersed portion in axial direction covering 3/4 or more in circumferential direction of lead wires.	The terminal of capacitor is dipped into a solution of ethanol (JIS K 8101) and rosin (JIS K 5902) (25% rosin in weight proportion). Immerse in solder solution for 2±0.5 seconds. In both cases the depth of dipping is up to about 1.5 to 2mm from the terminal body. Temp. of solder : 245±5°C Lead Free Solder(Sn-3.0Ag-0.5Cu) 235±5°C H60A or H63A Eutectic Solder															
11-1	Resistance to Soldering Heat (Non-Preheat)	Appearance	No defects or abnormalities															
		Capacitance Change	Within ±20%															
		Dielectric Strength (Between terminals)	No defects															
The lead wires should be immersed in the melted solder 1.5 to 2.0mm from the root of terminal at 260±5°C for 10±1 seconds. <ul style="list-style-type: none"> • Pre-treatment Capacitor should be stored at 150+0/-10°C for one hour, then place at *room condition for 24±2 hours before initial measurement. • Post-treatment Capacitor should be stored for 24±2 hours at *room condition. 																		
11-2	Resistance to Soldering Heat (On-Preheat)	Appearance	No defects or abnormalities															
		Capacitance Change	Within ±20%															
		Dielectric Strength (Between terminals)	No defects															
First the capacitor should be stored at 120+0/-5°C for 60+0/-5 seconds. Then, the lead wires should be immersed in the melted solder 1.5 to 2.0mm from the root of terminal at 260±5°C for 7.5+0/-1 seconds. <ul style="list-style-type: none"> • Pre-treatment Capacitor should be stored at 150+0/-10°C for one hour, then place at *room condition for 24±2 hours before initial measurement. • Post-treatment Capacitor should be stored for 24±2 hours at *room condition. 																		
11-3	Resistance to Soldering Heat (soldering iron method)	Appearance	No defects or abnormalities															
		Capacitance Change	Within ±20%															
		Dielectric Strength (Between terminals)	No defects															
Test condition Temperature of iron-tip : 350±10°C Soldering time : 3.5±0.5 seconds Soldering position Straight Lead: 1.5 to 2.0mm from the root of terminal. Crimp Lead: 1.5 to 2.0mm from the end of lead bend. <ul style="list-style-type: none"> • Pre-treatment Capacitor should be stored at 150+0/-10°C for one hour, then place at *room condition for 24±2 hours before initial measurement. • Post-treatment Capacitor should be stored for 24±2 hours at *room condition. 																		
12	Temperature Cycle	Appearance	No defects or abnormalities															
		Capacitance Change	Y5V : Within±30%															
		D.F.	Y5V : 0.075 max.															
		I.R.	1,000MΩ or 50MΩ·μF min. (Whichever is smaller)															
		Dielectric Strength (Between Terminals)	No defects or abnormalities															
Repeat 5 cycles according to the 4 heat treatments listed in the following table. Set at *room condition for 24±2 hours, then measure.																		
		<table border="1" style="width: 100%; text-align: center;"> <thead> <tr> <th>Step</th> <th>1</th> <th>2</th> <th>3</th> <th>4</th> </tr> </thead> <tbody> <tr> <td>Temp. (°C)</td> <td>Min. Operating Temp. ±3</td> <td>Room Temp.</td> <td>Max. Operating Temp. ±3</td> <td>Room Temp.</td> </tr> <tr> <td>Time (min.)</td> <td>30±3</td> <td>3 max.</td> <td>30±3</td> <td>3 max.</td> </tr> </tbody> </table>		Step	1	2	3	4	Temp. (°C)	Min. Operating Temp. ±3	Room Temp.	Max. Operating Temp. ±3	Room Temp.	Time (min.)	30±3	3 max.	30±3	3 max.
Step	1	2	3	4														
Temp. (°C)	Min. Operating Temp. ±3	Room Temp.	Max. Operating Temp. ±3	Room Temp.														
Time (min.)	30±3	3 max.	30±3	3 max.														
<ul style="list-style-type: none"> • Pretreatment Perform a heat treatment at 150+0/-10°C for one hour and then set at *room condition for 24±2 hours. 																		
13	Humidity (Steady State)	Appearance	No defects or abnormalities															
		Capacitance Change	Y5V : Within ±30%															
		D.F.	Y5V : 0.075 max.															
		I.R.	1,000MΩ or 50MΩ·μF min. (Whichever is smaller)															
Set the capacitor at 40±2°C and relative humidity 90 to 95% for 500+24/-0 hours. Remove and set at *room condition for 24±2 hours, then measure. <ul style="list-style-type: none"> • Pretreatment Perform a heat treatment at 150+0/-10°C for one hour and then set at *room condition for 24±2 hours. 																		
* "room condition" Temperature:15 to 35°C, Relative humidity:45 to 75%, Atmosphere pressure:86 to 106kPa																		

ESRDE107B

Reference only

No.	Item	Specification	Test Method
14	Humidity Load	Appearance	No defects or abnormalities
		Capacitance Change	Y5V : Within±30%
		D.F.	Y5V : 0.075 max.
		I.R.	500MΩ or 25MΩ·μF min. (Whichever is smaller)
			Apply the rated voltage at 40±2°C and relative humidity of 90 to 95% for 500+24/-0 hours. Remove and set at *room condition for 24±2 hours, then measure. (Charge/Discharge current ≤ 50mA) • Pretreatment Perform a heat treatment at 150+0/-10°C for one hour and then set at *room condition for 24±2 hours.
15	High Temperature Load	Appearance	No defects or abnormalities
		Capacitance Change	Y5V : Within±30%
		D.F.	Y5V : 0.075 max.
		I.R.	1,000MΩ or 50 MΩ·μF min. (Whichever is smaller)
			Apply 150% of the rated voltage at the maximum operating temperature ±3°C for 1000+48/-0 hours. Remove and set at *room condition for 24±2 hours, then measure. (Charge/Discharge current ≤ 50mA) • Pretreatment Apply test voltage for one hour at test temperature. Remove and set at *room condition for 24±2 hours.
16	Solvent Resistance	Appearance	No defects or abnormalities
		Marking	Legible
			The capacitor should be fully immersed, unagitated, in reagent at 20 to 25°C for 30±5 sec. and then remove gently. Marking on the surface of the capacitor shall immediately be visually examined. Reagent : Isopropyl alcohol

* "room condition" Temperature:15 to 35°C, Relative humidity:45 to 75%, Atmosphere pressure:86 to 106kPa

Reference only

6. Packing specification

- Bulk type (Packing style code : B)

The number of packing = $\frac{\text{Packing quantity}}{\text{Packing quantity}} \times n$

The size of packing case and packing way

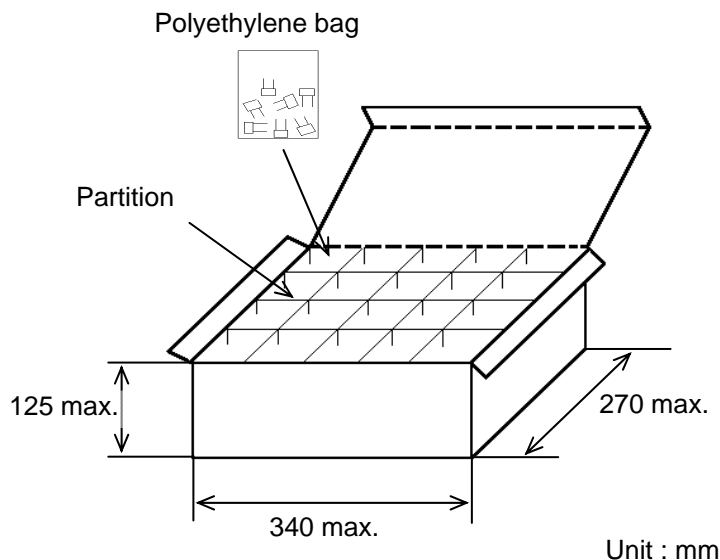

- *1 : Please refer to [Part number list].
- *2 : Standard n = 20 (bag)

Note)
The outer package and the number of outer packing be changed by the order getting amount.

- Ammo pack taping type (Packing style code : A)

- A crease is made every 25 pitches, and the tape with capacitors is packed zigzag into a case.
- When body of the capacitor is piled on other body under it.

The size of packing case and packing way

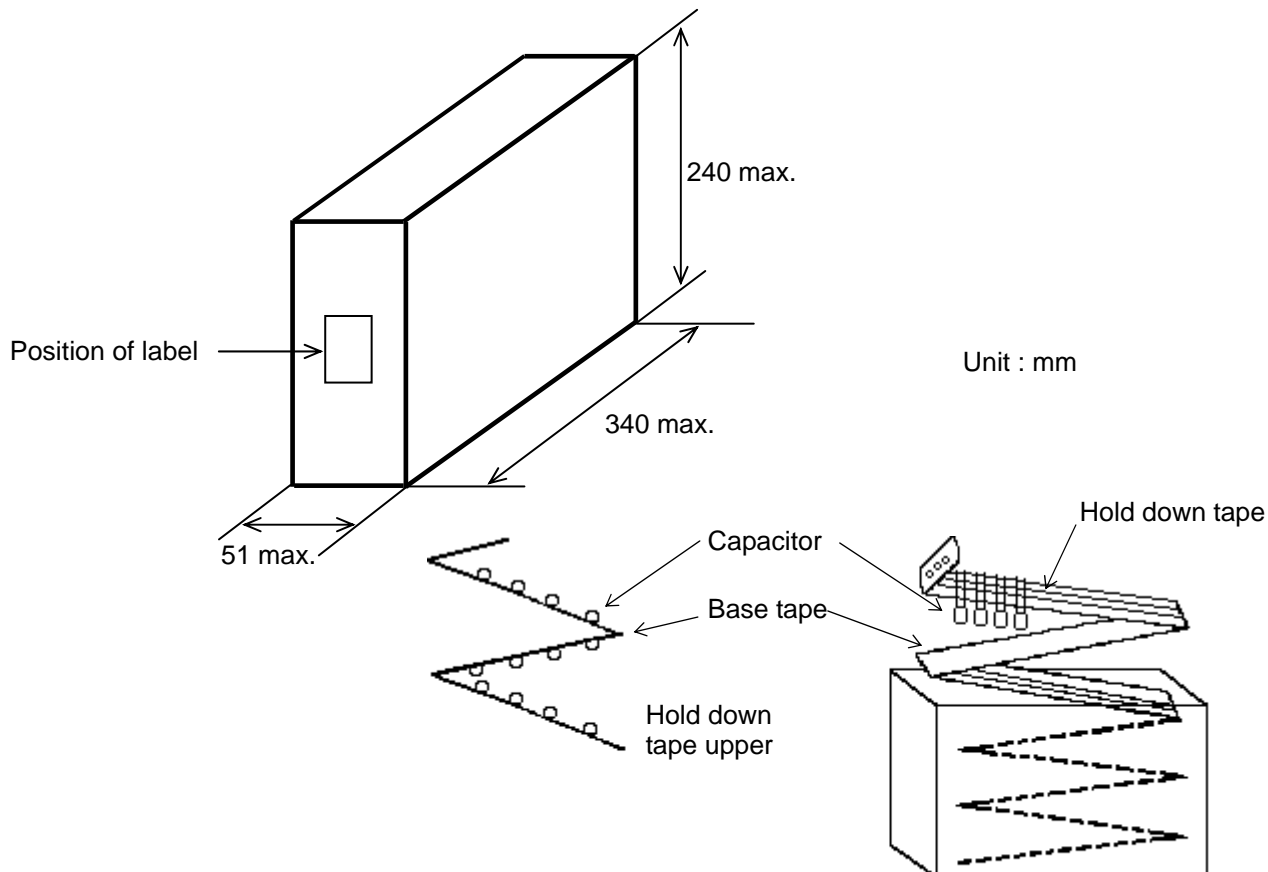

Reference only

7. Taping specification

7-1. Dimension of capacitors on tape

Inside crimp taping type < Lead code : M1 >

Pitch of component 12.7mm / Lead spacing 5.0mm

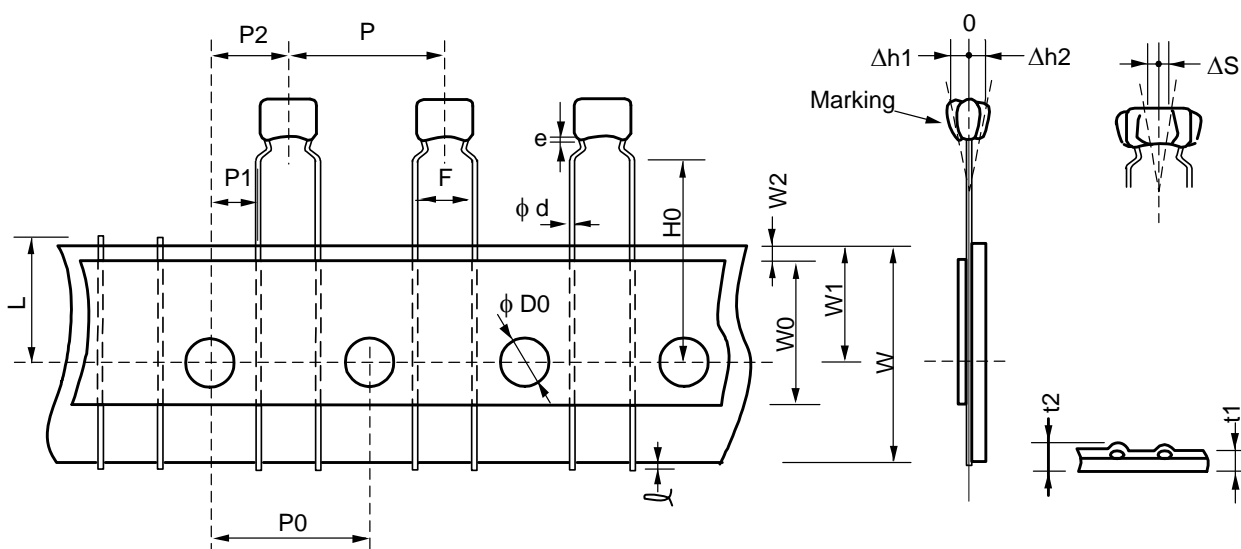

Unit : mm

Item	Code	Dimensions	Remarks
Pitch of component	P	12.7+/-1.0	
Pitch of sprocket hole	P0	12.7+/-0.2	
Lead spacing	F	5.0+0.6/-0.2	
Length from hole center to component center	P2	6.35+/-1.3	Deviation of progress direction
Length from hole center to lead	P1	3.85+/-0.7	
Deviation along tape, left or right defect	ΔS	0+/-2.0	They include deviation by lead bend .
Carrier tape width	W	18.0+/-0.5	
Position of sprocket hole	W1	9.0+0/-0.5	Deviation of tape width direction
Lead distance between reference and bottom plane	H0	16.0+/-0.5	
Protrusion length	ℓ	0.5 max.	
Diameter of sprocket hole	D0	4.0+/-0.1	
Lead diameter	φd	0.50+/-0.05	
Total tape thickness	t1	0.6+/-0.3	They include hold down tape thickness.
Total thickness of tape and lead wire	t2	1.5 max.	
Deviation across tape	Δh1	2.0 max. (Dimension code : W)	
	Δh2	1.0 max. (except as above)	
Portion to cut in case of defect	L	11.0+0/-1.0	
Hold down tape width	W0	9.5 min.	
Hold down tape position	W2	1.5+/-1.5	
Coating extension on lead	e	Up to the end of crimp	

Reference only

Outside crimp taping type < Lead code : S1 >
Pitch of component 12.7mm / Lead spacing 2.5mm

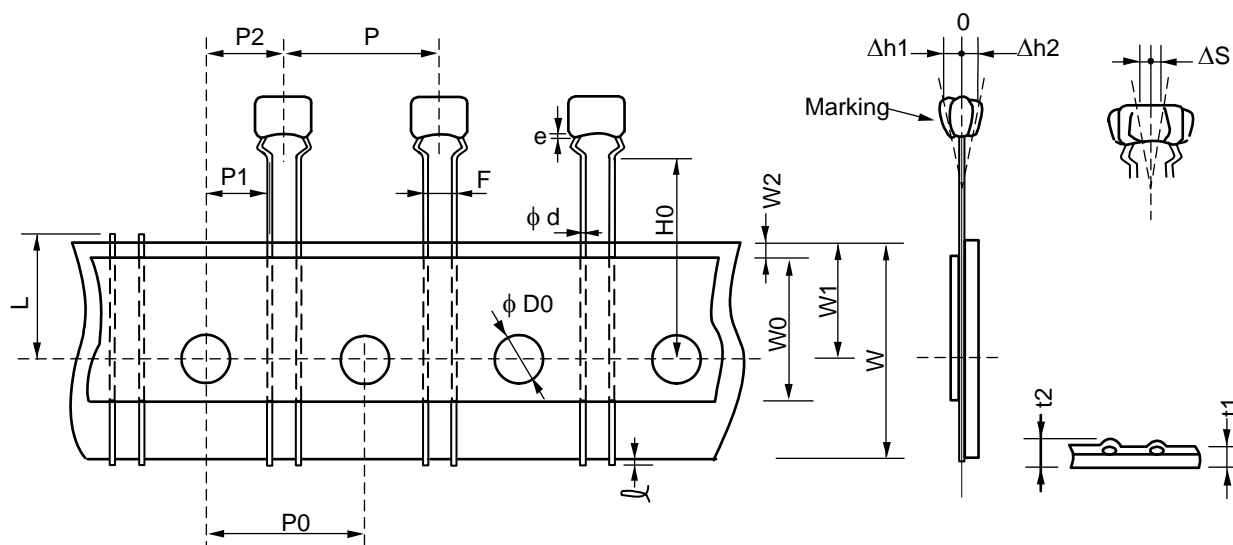

Unit : mm

Item	Code	Dimensions	Remarks
Pitch of component	P	12.7+/-1.0	
Pitch of sprocket hole	P0	12.7+/-0.2	
Lead spacing	F	2.5+0.4/-0.2	
Length from hole center to component center	P2	6.35+/-1.3	Deviation of progress direction
Length from hole center to lead	P1	3.85+/-0.7	
Deviation along tape, left or right defect	ΔS	0+/-2.0	They include deviation by lead bend .
Carrier tape width	W	18.0+/-0.5	
Position of sprocket hole	W1	9.0+0/-0.5	Deviation of tape width direction
Lead distance between reference and bottom plane	H0	16.0+/-0.5	
Protrusion length	ℓ	0.5 max.	
Diameter of sprocket hole	D0	4.0+/-0.1	
Lead diameter	d	0.50+/-0.05	
Total tape thickness	t1	0.6+/-0.3	They include hold down tape thickness.
Total thickness of tape and lead wire	t2	1.5 max.	
Deviation across tape	Δh1	1.0 max.	
	Δh2		
Portion to cut in case of defect	L	11.0+0/-1.0	
Hold down tape width	W0	9.5 min.	
Hold down tape position	W2	1.5+/-1.5	
Coating extension on lead	e	Up to the end of crimp	

Reference only

7-2. Splicing way of tape

- 1) Adhesive force of tape is over 3N at test condition as below.

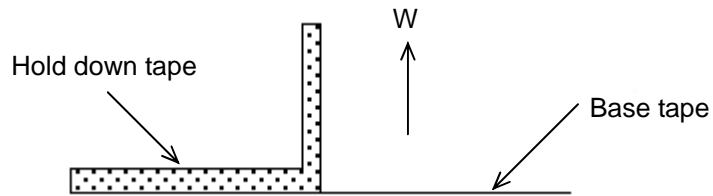

2) Splicing of tape

- a) When base tape is spliced

- Base tape shall be spliced by cellophane tape.
(Total tape thickness shall be less than 1.05mm.)

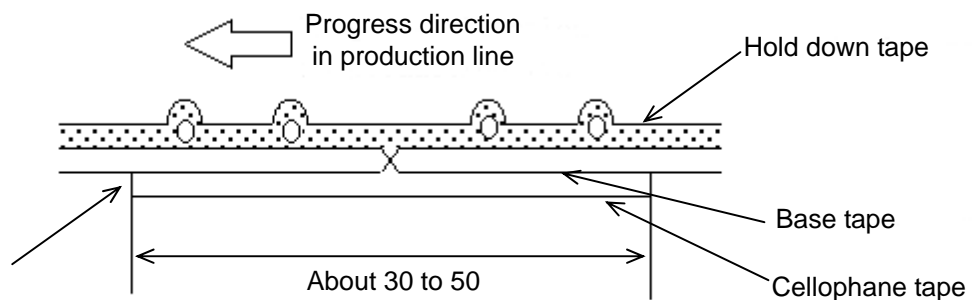

No lifting for the direction of progressing

Unit : mm

- b) When hold down tape is spliced

- Hold down tape shall be spliced with overlapping.
(Total tape thickness shall be less than 1.05mm.)

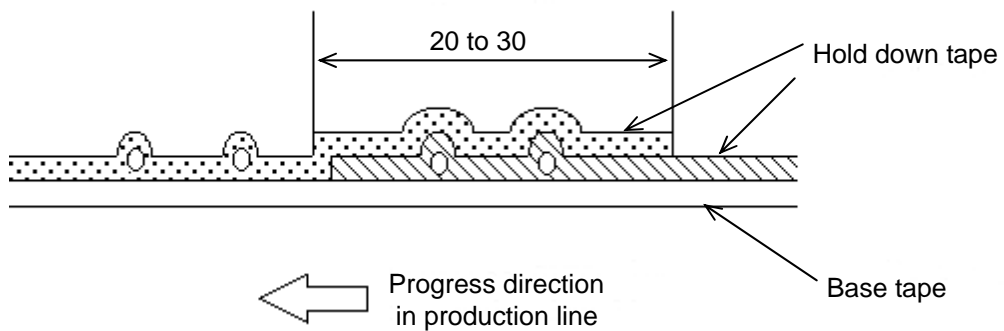

Unit : mm

- c) When both tape are spliced

- Base tape and hold down tape shall be spliced with splicing tape.

EU RoHS and Halogen Free

This products of the following crresponds to EU RoHS and Halogen Free

(1) RoHS

EU RoHs 2011/65/EC compliance

maximum concentration values tolerated by weight in homogeneous materials

- 1000 ppm maximum Lead
- 1000 ppm maximum Mercury
- 100 ppm maximum Cadmium
- 1000 ppm maximum Hexavalent chromium
- 1000 ppm maximum Polybrominated biphenyls (PBB)
- 1000 ppm maximum Polybrominated diphenyl ethers (PBDE)

(2) Halogen-Free

The International Electrochemical Commission' s (IEC) Definition of Halogen-Free (IEC 61249-2-21) compliance

- 900 ppm maximum chlorine
- 900 ppm maximum bromine
- 1500 ppm maximum total chlorine and bromine

X-ON Electronics

Largest Supplier of Electrical and Electronic Components

Click to view similar products for [Murata manufacturer](#):

Other Similar products are found below :

[CSTCE20M0V53-R0](#) [DEA1X3F150JP3A](#) [NTPAA2R2LDNB0](#) [CSTCE16M0V53-R0](#) [GQM2195C1H470JB01D](#) [LQH3NPN1R0MM0L](#)
[GRM188R71E473KA01D](#) [DLW5BTN501SQ2L](#) [GRM31CR70J106KA01L](#) [GRM155C80J105KE15D](#) [GRM21BR61H225KA73L](#)
[MGJ2D051515SC](#) [82224C](#) [82473C](#) [GCJ31CR71H105KA12L](#) [GRM2165C1H101FA01D](#) [GRM55D7U3A103JW31L](#)
[PTGL09AS2R2K3B51B0](#) [11R683C](#) [1217AS-H-1R5N=P3](#) [DD1274AS-H-220M=P3](#) [1447440C](#) [BPM15-120-Q12P-C](#) [NMK1212SC](#)
[NMV1212DAC](#) [NXFT15XH103FA2B090](#) [LQH43MN330J03L](#) [GCM31CR71C106KA64K](#) [GRM033R71E122KA01D](#)
[GRM1885C1H150FA01J](#) [GRM3195C2A471JD01D](#) [GRM55DR72E684KW01L](#) [RF1211C](#) [RF1238](#) [B1047AS-220M=P3](#) [MGJ2D121509SC](#)
[MGJ6D122005LMC-R7](#) [#B953AS-330M=P3](#) [HN-214](#) [HN-214X](#) [TZ03P450](#) [UEE-12/12.5-D48NB-C](#) [LBWB1ZZYDZ-DTEMP-SNIC-](#)
[UART-A](#) [LLM315R70J225MA11L](#) [46334C](#) [DMS-40LCD-420S-C](#) [DR4103](#) [NCS3S4815SC](#) [NKE1212DC](#) [NMA1215SC](#)