

SAW FILTER FOR GSM900/Band8 Rx

Murata part number: SAFEA942MFL0F00

Package Dimensions

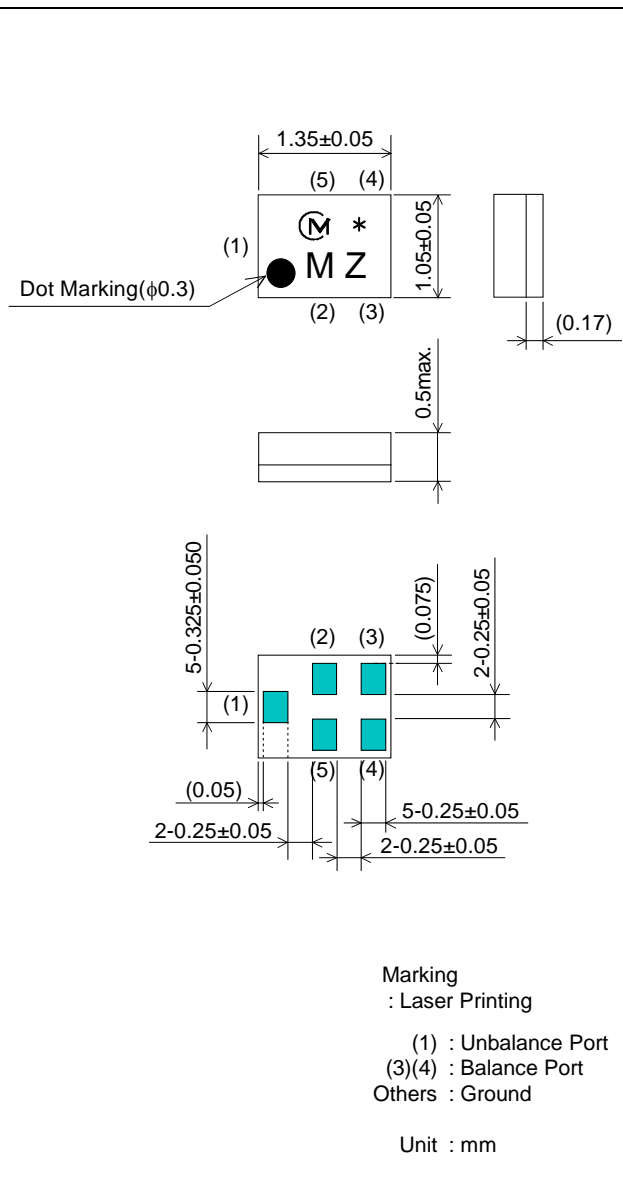

Specification

Item	Specification		
	-30 to 85°C	25±2°C	typ.
Nominal Center Frequency (fc)	942.5MHz		
Insertion Loss (925 to 960 MHz)	2.3 dB max.	1.9 dB max.	1.6 dB
Absolute Attenuation			
1) 0.1 to 860 MHz	50 dB min.	50 dB min.	58 dB
2) 860 to 880 MHz	50 dB min.	50 dB min.	58 dB
3) 880 to 905 MHz	30 dB min.	30 dB min.	49 dB
4) 905 to 915 MHz	25 dB min.	25 dB min.	29 dB
5) 980 to 1030 MHz	25 dB min.	25 dB min.	29 dB
6) 1030 to 1040 MHz	45 dB min.	45 dB min.	50 dB
7) 1040 to 2500 MHz	45 dB min.	45 dB min.	55 dB
8) 2500 to 6000 MHz	35 dB min.	35 dB min.	49 dB
Ripple Deviation (925 to 960 MHz)	1.4dB max.	0.9dB max.	0.4 dB
VSWR (925 to 960 MHz)	2.0 max.	1.9 max.	1.7
Amplitude Balance (925 to 960 MHz)	±0.5dB max.	±0.5dB max.	±0.2 dB
Phase Balance (925 to 960 MHz)	180±5deg. max.	180±5deg. max.	±1.5 deg.
Balance Port Matching Impedance (nominal)	150Ω//82nH		
Unbalance Port Matching Impedance (nominal)	50Ω		
Input Signal Level	31.6mW (+15dBm), 2000 hours		

SAW FILTER FOR GSM900/Band8 Rx

Murata part number: SAFEA942MFL0F00

Frequency Performance

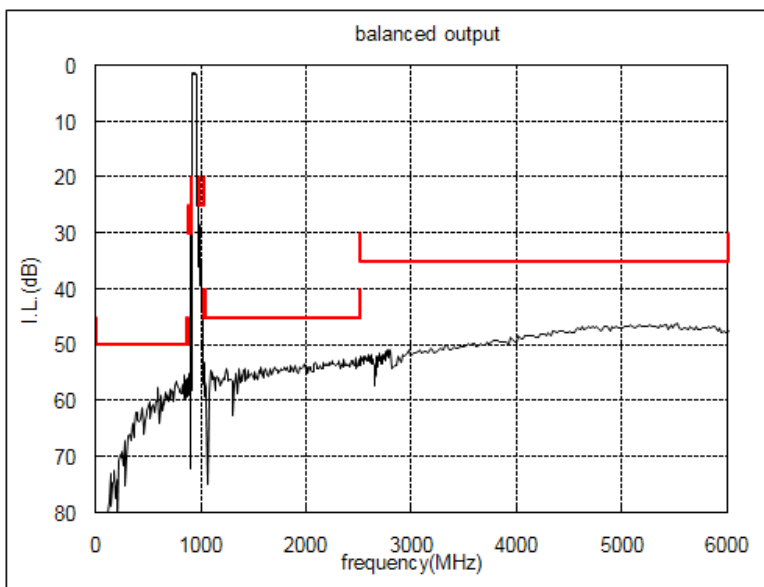
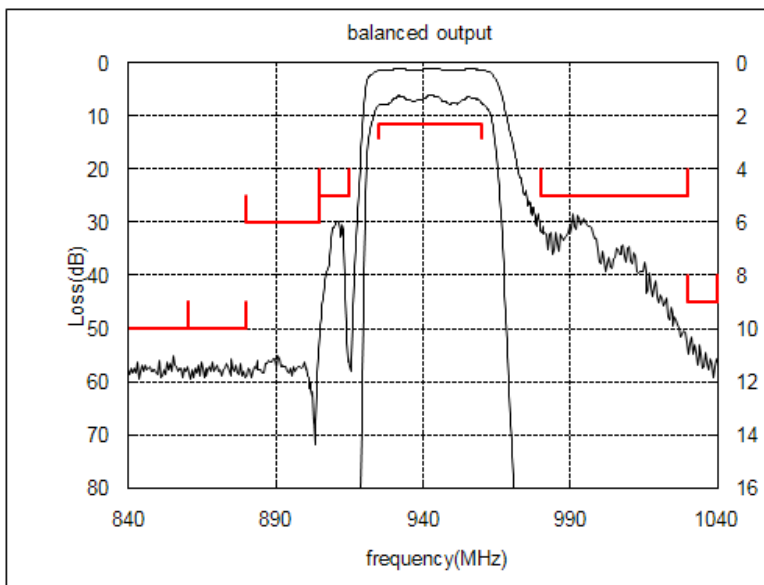

Amplitude balance

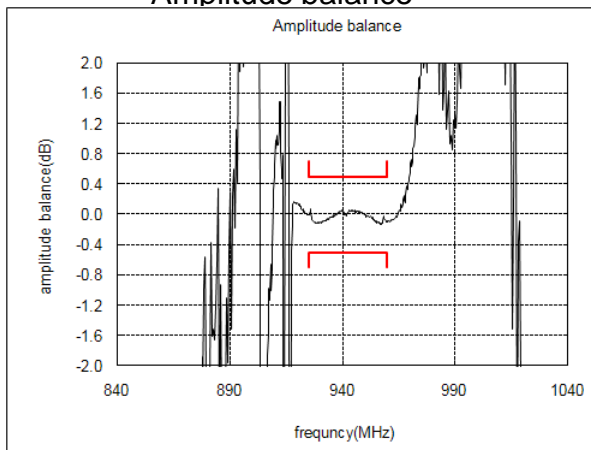

Phase balance

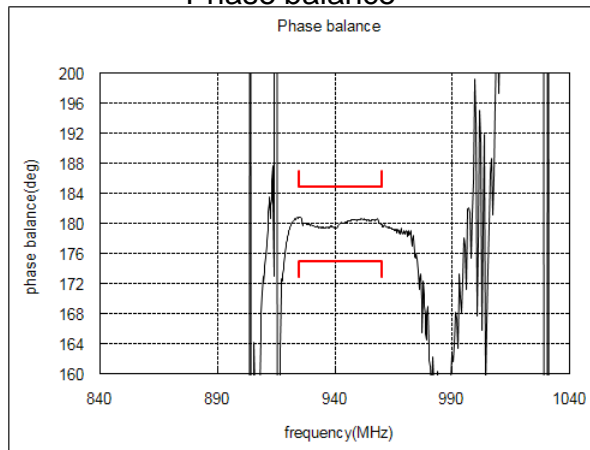

SAW FILTER FOR GSM900/Band8 Rx

Murata part number: SAFEA942MFL0F00

Dimensions of Carrier Tape

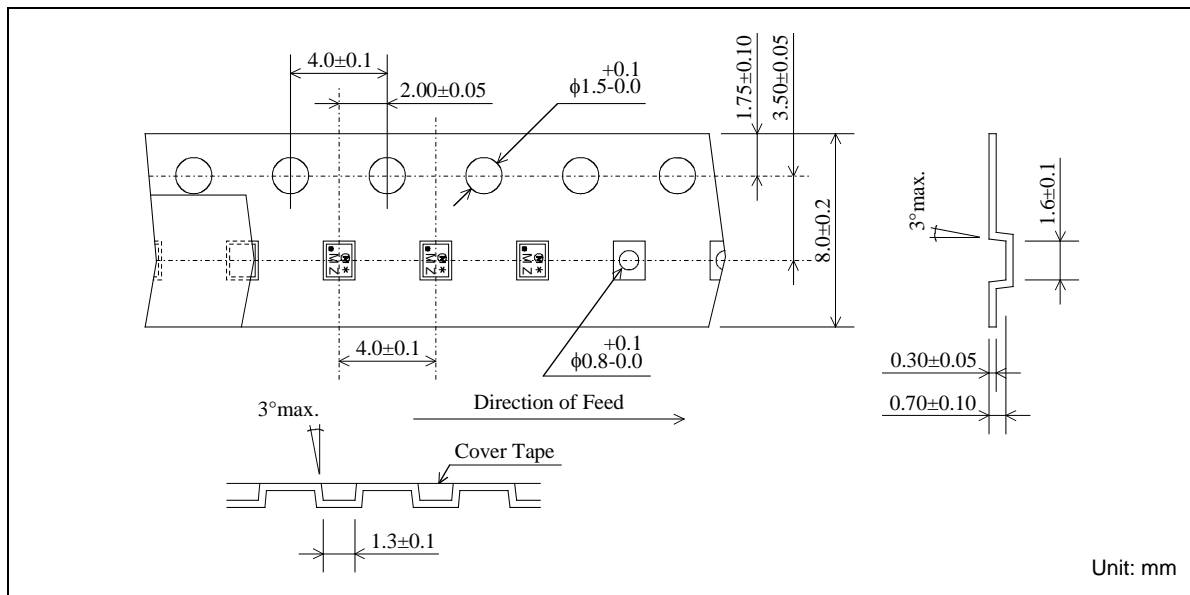

Dimensions of Tape

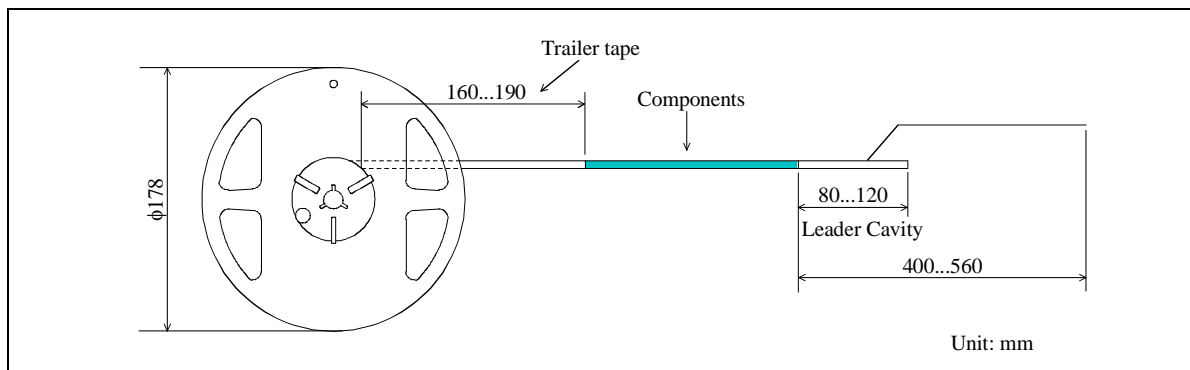

Dimensions of Reel

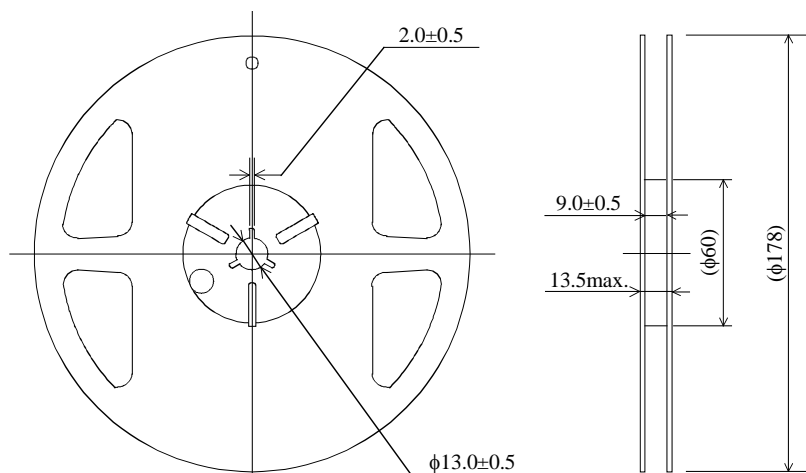

Unit: mm

SAFEA942MFL0F00R14 ... 4000pcs/reel

SAFEA942MFL0F00R12 ... 2000pcs/reel

SAW FILTER FOR GSM900/Band8 Rx

Murata part number: SAFEA942MFL0F00

Recommended Land Pattern

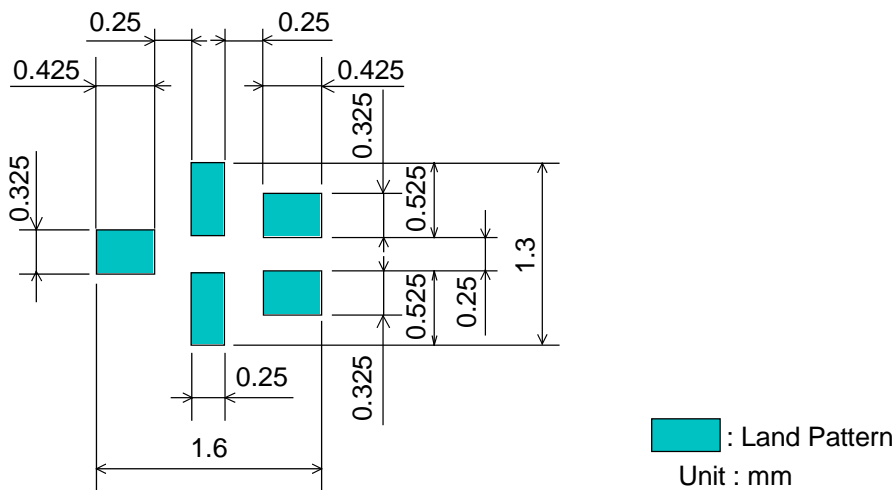

Test Circuit

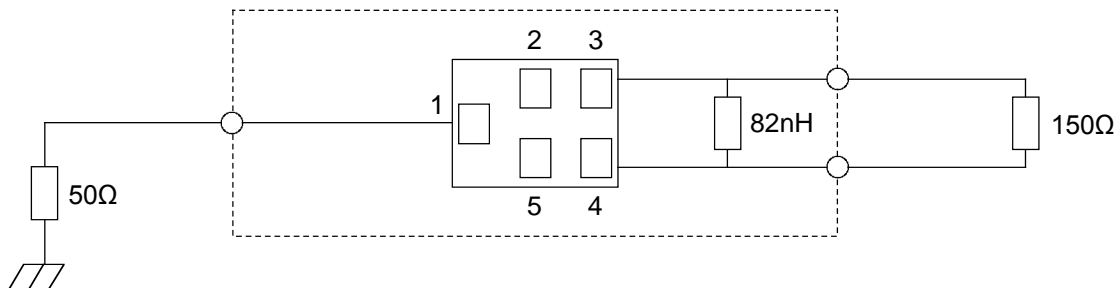

- This PDF Datasheet is downloaded from the website of Murata Manufacturing Co., Ltd. Therefore, it's specifications are subject to change or our products in it may be discontinued without advance notice. Please check with our sales representatives or product engineers before ordering.
- This PDF Datasheet has only typical specifications because there is no space for detailed specifications. Therefore, please approve our product specifications or transact the approval sheet for product specifications before ordering.

X-ON Electronics

Largest Supplier of Electrical and Electronic Components

Click to view similar products for [Signal Conditioning](#) category:

Click to view products by [Murata](#) manufacturer:

Other Similar products are found below :

[MAPDCC0001](#) [MAPDCC0004](#) [PD0409J5050S2HF](#) [HHS-109-PIN](#) [AFS14A30-2185.00-T3](#) [AFS14A35-1591.50-T3](#) [DS-323-PIN](#) [DSS-313-PIN](#) [B39321R801H210](#) [1A0220-3](#) [JP510S](#) [LFB212G45SG8C341](#) [LFB322G45SN1A504](#) [LFL182G45TC3B746](#) [SF2159E](#) [30057](#)
[AFS1575.42S4-T](#) [FM-104-PIN](#) [CER0813B](#) [MAPDCC0005](#) [3A325](#) [40287](#) [41180](#) [ATB3225-75032NCT](#) [BD0810N50100AHF](#) [JHS-115-PIN](#)
[DC0710J5005AHF](#) [DC2327J5005AHF](#) [43020](#) [LFB2H2G60BB1C106](#) [LFL15869MTC1B787](#) [X3C19F1-20S](#) [XC3500P-20S](#) [10013-20](#)
[SF2194E](#) [CDBLB455KCAX39-B0](#) [TGL2208-SM, EVAL](#) [RF1353C](#) [051157-0000](#) [PD0922J5050D2HF](#) [1E1305-3](#) [1F1304-3S](#) [1G1304-30](#)
[B0922J7575AHF](#) [10017-3](#) [TP-103-PIN](#) [BD1222J50200AHF](#) [BD1722J50100AHF](#) [2450DP39K5400E](#) [BD0810J50150AHF](#)