

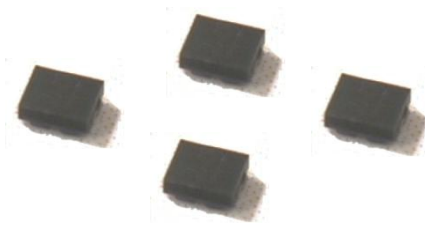

Data Sheet of SAW Components



Note : Murata SAW Component is applicable for Cellular /Cordless phone (Terminal) relevant market only.

Please also read caution at the end of this document.

SAW FILTER FOR GSM900 Rx

Murata part number : SAFFB942MFL0F0A

Package Dimensions

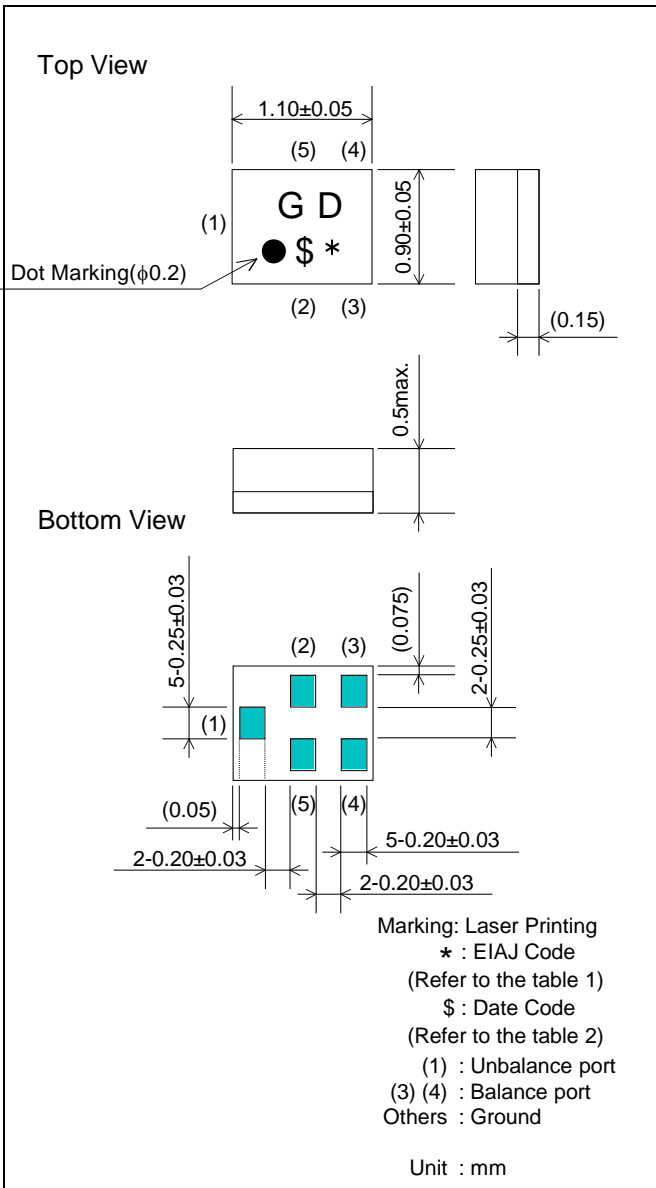

Specification

| Item | Specification | | |
|---|-----------------------------|----------------|-------------|
| | -30 to 85°C | 25±2°C | typ. |
| Nominal Center Frequency(f_c) | 942.5MHz | | |
| Insertion Loss (925 to 960MHz) | 2.3 dB max. | 1.9 dB max. | 1.5 dB |
| Absolute Attenuation | | | |
| 1) 0.1 to 860 MHz | 50 dB min. | 50 dB min. | 59 dB |
| 2) 860 to 880 MHz | 50 dB min. | 50 dB min. | 63 dB |
| 3) 880 to 905 MHz | 30 dB min. | 30 dB min. | 54 dB |
| 4) 905 to 915 MHz | 25 dB min. | 25 dB min. | 31 dB |
| 5) 980 to 1030 MHz | 25 dB min. | 25 dB min. | 30 dB |
| 6) 1030 to 1040 MHz | 45 dB min. | 45 dB min. | 50 dB |
| 7) 1040 to 2500 MHz | 45 dB min. | 45 dB min. | 56 dB |
| 8) 2500 to 6000 MHz | 35 dB min. | 35 dB min. | 46 dB |
| Ripple Deviation (925 to 960MHz) | 1.4 dB max. | 0.9 dB max. | 0.5 dB |
| VSWR (925 to 960MHz) | 2.0 max. | 1.9 max. | 1.7 |
| Amplitude Balance (925 to 960MHz) | ±0.5dB max. | ±0.5dB max. | -0.2dB |
| Phase Balance (925 to 960MHz) | 180±5deg. max. | 180±5deg. max. | 180+1.4deg. |
| Unbalance Port Matching Impedance (nominal) | 50Ω | | |
| Balance Port Matching Impedance (nominal) | 150Ω//82nH | | |
| Input Signal Level | 31.6mW (+15dBm), 2000 hours | | |

SAW FILTER FOR GSM900 Rx

Murata part number : SAFFB942MFL0F0A

Frequency Performance

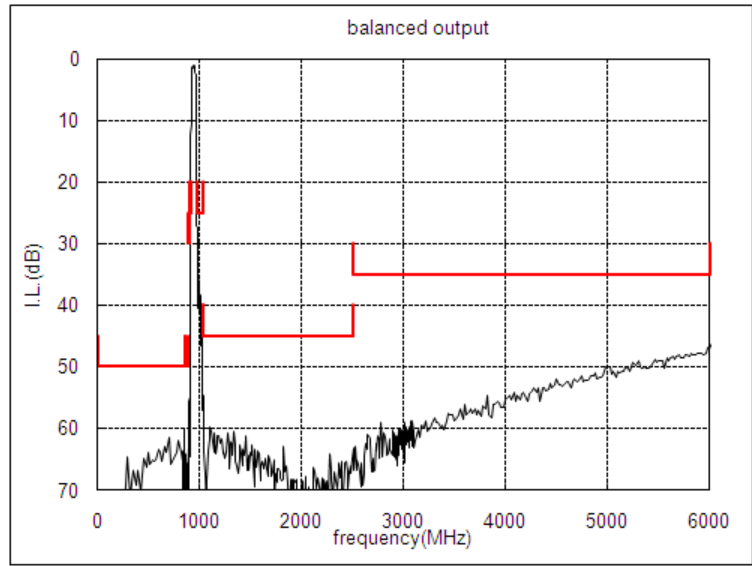
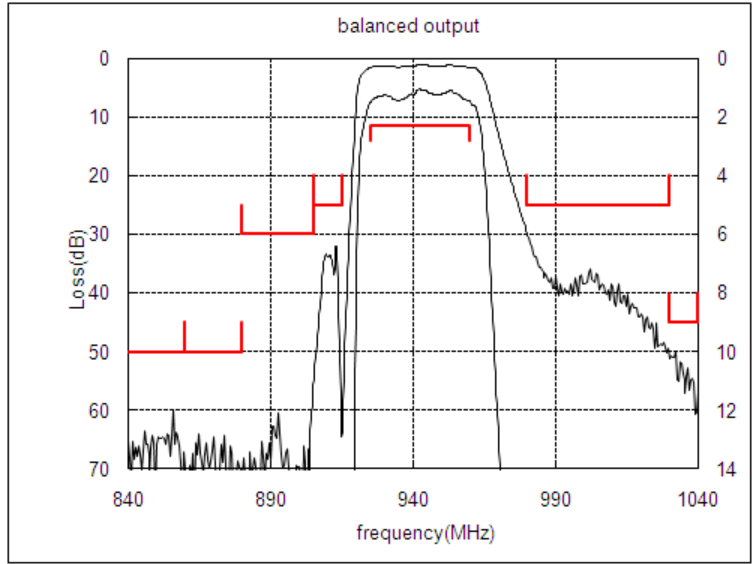

Amplitude balance

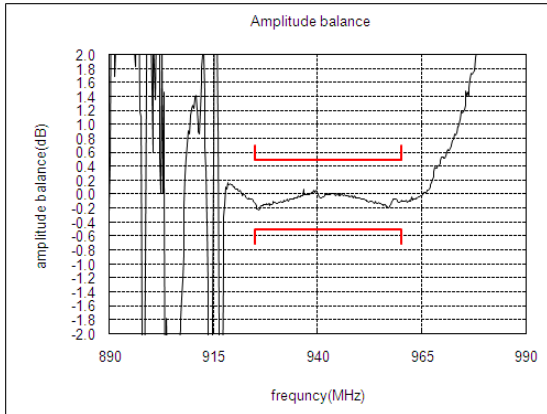

Phase balance

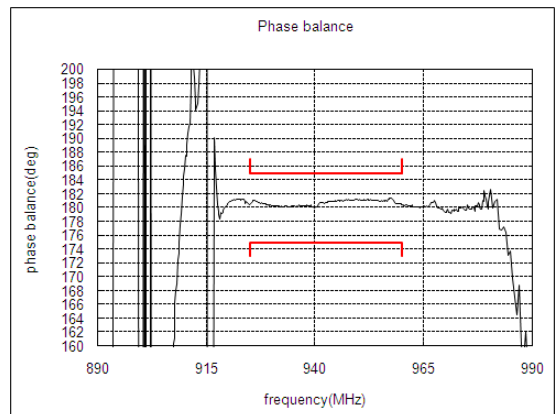

SAW FILTER FOR GSM900 Rx

Murata part number : SAFFB942MFL0F0A

Dimensions of Carrier Tape

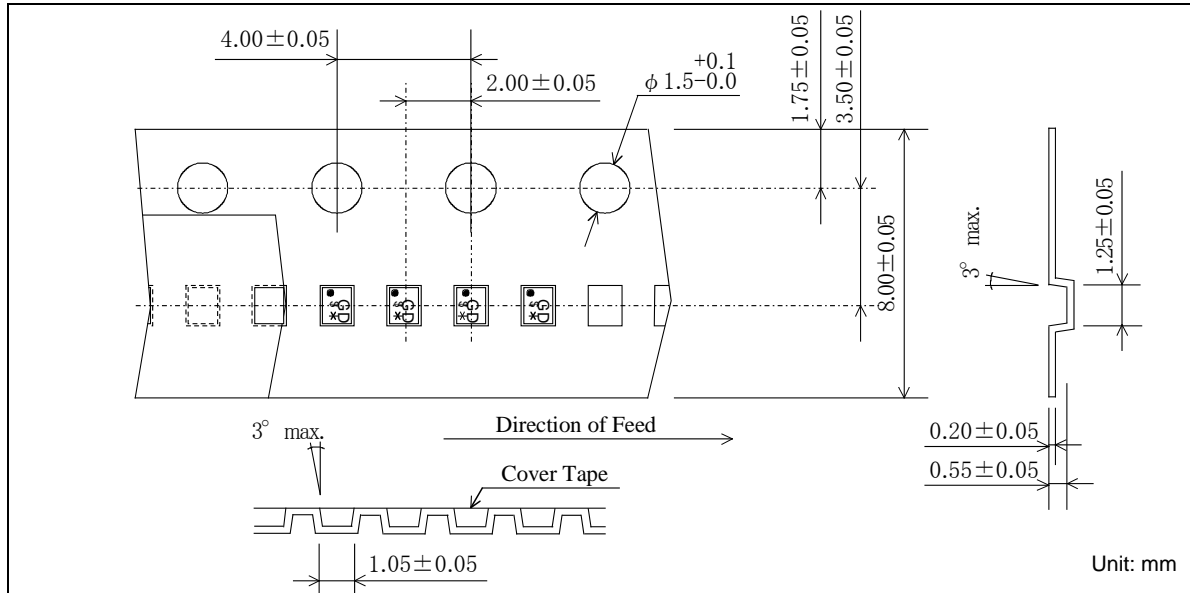

Dimensions of Tape

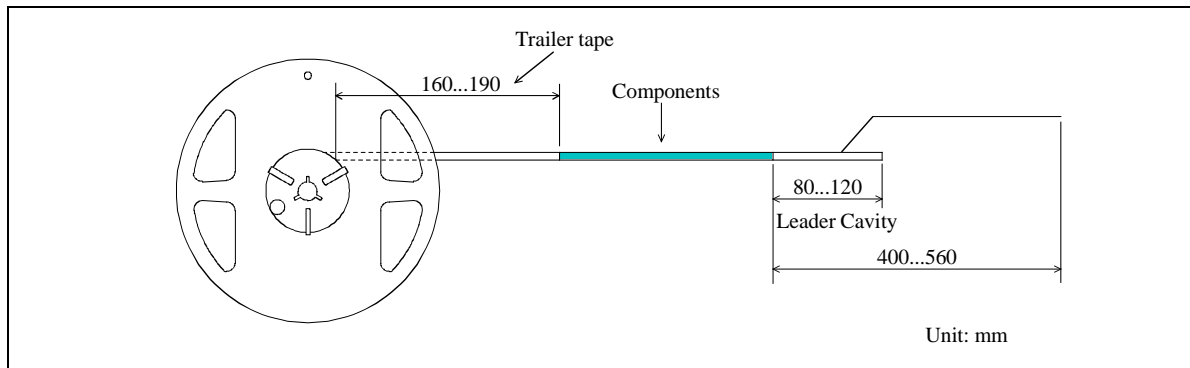

Dimensions of Reel

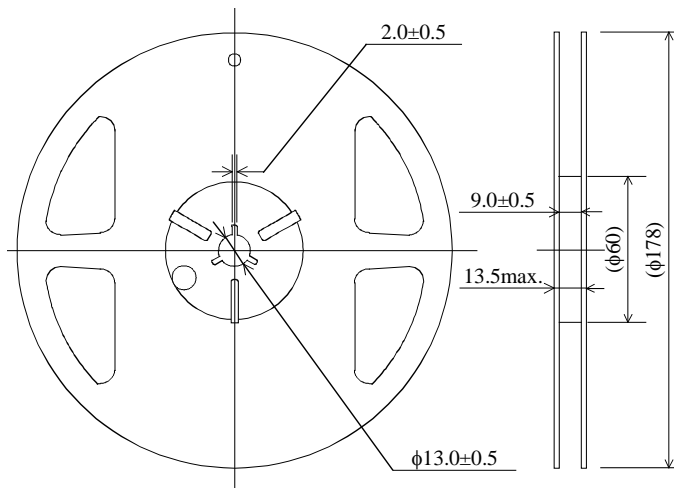

SAFFB942MFL0F0AR1X ... 10000pcs/reel
 SAFFB942MFL0F0AR15 ... 5000pcs/reel

SAW FILTER FOR GSM900 Rx

Murata part number : SAFFB942MFL0F0A

Recommended Land Pattern

Top View

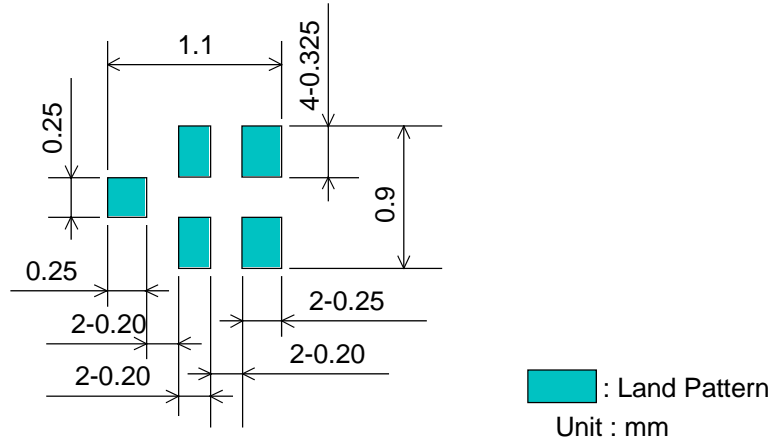

Test Circuit

Bottom View

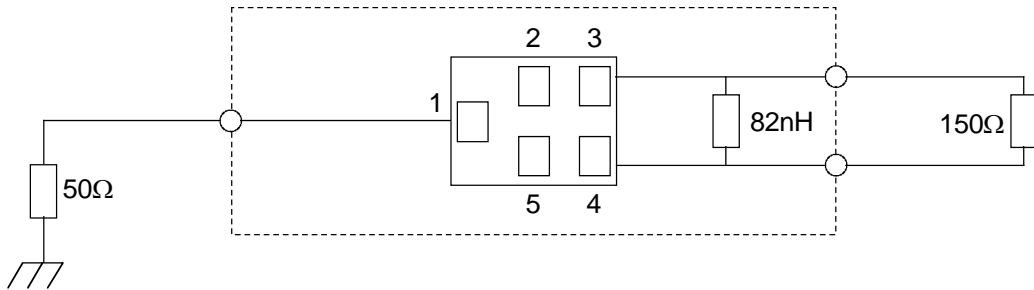

SAW FILTER FOR GSM900 Rx

Murata part number : SAFFB942MFL0F0A

■ RoHS Compliance

This component is compliant with RoHS directive.

This component was always RoHS compliant from the first date of manufacture.

• Caution - Limitation of Applications

This product is intended for the following applications only; however, please do not use this product in these applications where defects might directly cause damage to a third party's life, body or property.

- a. Mobile Telephone
- b. Cordless phone (except for Automotive use)
- c. PC (Including Notebook PC, Netbook PC, Tablet)
- d. Game
- e. Camera (except for Business/security use)
- f. Set Top Box
- g. Electronic dictionary
- h. Digital audio equipment

• This catalog is for reference only and not an official product specification document, therefore, please review and approve our official product specification before ordering this product.

■ Marking code

Table 1 * : EIAJ Code

This rule of code is applied repeatedly every four year.

| | | | | | | | | | | | | |
|------|------|------|------|------|-----|------|------|------|------|------|------|------|
| 2009 | Jan. | Feb. | Mar. | Apr. | May | Jun. | Jul. | Aug. | Sep. | Oct. | Nov. | Dec. |
| 2013 | A | B | C | D | E | F | G | H | J | K | L | M |
| 2017 | | | | | | | | | | | | |
| 2010 | Jan. | Feb. | Mar. | Apr. | May | Jun. | Jul. | Aug. | Sep. | Oct. | Nov. | Dec. |
| 2014 | N | P | Q | R | S | T | U | V | W | X | Y | Z |
| 2018 | | | | | | | | | | | | |
| 2011 | Jan. | Feb. | Mar. | Apr. | May | Jun. | Jul. | Aug. | Sep. | Oct. | Nov. | Dec. |
| 2015 | a | b | c̄ | d | e | f | g | h | j | k | l | m |
| 2019 | | | | | | | | | | | | |
| 2012 | Jan. | Feb. | Mar. | Apr. | May | Jun. | Jul. | Aug. | Sep. | Oct. | Nov. | Dec. |
| 2016 | n | p | q | r | s | t | u | v | w | x | y | z |
| 2020 | | | | | | | | | | | | |

Table 2 \$: Date Code

| | | | | | | | | | | | |
|------|------|------|------|------|------|------|------|------|------|------|------|
| date | 1st | 2nd | 3rd | 4th | 5th | 6th | 7th | 8th | 9th | 10th | |
| code | A | B | C | D | E | F | G | H | J | K | |
| date | 11th | 12th | 13th | 14th | 15th | 16th | 17th | 18th | 19th | 20th | |
| code | L | M | N | P | Q | R | S | T | U | V | |
| date | 21st | 22nd | 23rd | 24th | 25th | 26th | 27th | 28th | 29th | 30th | 31st |
| code | W | X | Y | Z | a | b | c̄ | d | e | f | g |

SAW FILTER FOR GSM900 Rx

Murata part number : SAFFB942MFL0F0A

■ Important notice

PLEASE READ THIS NOTICE BEFORE USING OUR PRODUCTS.

Please make sure that your product has been evaluated and confirmed from the aspect of the fitness for the specifications of our product when our product is mounted to your product.

All the items and parameters in this product specification/datasheet/catalog have been prescribed on the premise that our product is used for the purpose, under the condition and in the environment specified in this specification. You are requested not to use our product deviating from the condition and the environment specified in this specification.

Please note that the only warranty that we provide regarding the products is its conformance to the specifications provided herein. Accordingly, we shall not be responsible for any defects in products or equipment incorporating such products, which are caused under the conditions other than those specified in this specification.

WE HEREBY DISCLAIMS ALL OTHER WARRANTIES REGARDING THE PRODUCTS, EXPRESS OR IMPLIED, INCLUDING WITHOUT LIMITATION ANY WARRANTY OF FITNESS FOR A PARTICULAR PURPOSE, THAT THEY ARE DEFECT-FREE, OR AGAINST INFRINGEMENT OF INTELLECTUAL PROPERTY RIGHTS.

The product shall not be used in any application listed below which requires especially high reliability for the prevention of such defect as may directly cause damage to the third party's life, body or property. You acknowledge and agree that, if you use our products in such applications, we will not be responsible for any failure to meet such requirements. Furthermore, YOU AGREE TO INDEMNIFY AND DEFEND US AND OUR AFFILIATES AGAINST ALL CLAIMS, DAMAGES, COSTS, AND EXPENSES THAT MAY BE INCURRED, INCLUDING WITHOUT LIMITATION, ATTORNEY FEES AND COSTS, DUE TO THE USE OF OUR PRODUCTS IN SUCH APPLICATIONS.

- Aircraft equipment.
- Aerospace equipment
- Undersea equipment.
- Power plant control equipment - Medical equipment.
- Transportation equipment (vehicles, trains, ships, elevator, etc.).
- Traffic signal equipment.
- Disaster prevention / crime prevention equipment.
- Burning / explosion control equipment
- Application of similar complexity and/ or reliability requirements to the applications listed in the above.

We expressly prohibit you from analyzing, breaking, Reverse-Engineering, remodeling altering, and reproducing our product. Our product cannot be used for the product which is prohibited from being manufactured, used, and sold by the regulations and laws in the world.

We do not warrant or represent that any license, either express or implied, is granted under any our patent right, copyright, mask work right, or our other intellectual property right relating to any combination, machine, or process in which our products or services are used. Information provided by us regarding third-party products or services does not constitute a license from us to use such products or services or a warranty or endorsement thereof. Use of such information may require a license from a third party under the patents or other intellectual property of the third party, or a license from us under our patents or other intellectual property.

Please do not use our products, our technical information and other data provided by us for the purpose of developing of mass-destruction weapons and the purpose of military use.

Moreover, you must comply with "foreign exchange and foreign trade law", the "U.S. export administration regulations", etc.

Please note that we may discontinue the manufacture of our products, due to reasons such as end of supply of materials and/or components from our suppliers.

SAW FILTER FOR GSM900 Rx

Murata part number : SAFFB942MFL0F0A

Customer acknowledges that Murata will, if requested by you, conduct a failure analysis for defect or alleged defect of Products only at the level required for consumer grade Products, and thus such analysis may not always be available or be in accordance with your request (for example, in cases where the defect was caused by components in Products supplied to Murata from a third party).

The product shall not be used in any other application/model than that of claimed to Murata.

Customer acknowledges that engineering samples may deviate from specifications and may contain defects due to their development status.

We reject any liability or product warranty for engineering samples.

In particular we disclaim liability for damages caused by

- the use of the engineering sample other than for evaluation purposes, particularly the installation or integration in the product to be sold by you,
- deviation or lapse in function of engineering sample,
- improper use of engineering samples.

We disclaims any liability for consequential and incidental damages.

If you can't agree the above contents, you should inquire our sales.

X-ON Electronics

Largest Supplier of Electrical and Electronic Components

Click to view similar products for [Signal Conditioning](#) category:

Click to view products by [Murata](#) manufacturer:

Other Similar products are found below :

[MAPDCC0001](#) [MAPDCC0004](#) [PD0409J5050S2HF](#) [HHS-109-PIN](#) [AFS14A30-2185.00-T3](#) [AFS14A35-1591.50-T3](#) [DS-323-PIN](#) [DSS-313-PIN](#) [B39321R801H210](#) [1A0220-3](#) [JP510S](#) [LFB212G45SG8C341](#) [LFB322G45SN1A504](#) [LFL182G45TC3B746](#) [SF2159E](#) [30057](#)
[AFS1575.42S4-T](#) [FM-104-PIN](#) [CER0813B](#) [MAPDCC0005](#) [3A325](#) [40287](#) [41180](#) [ATB3225-75032NCT](#) [BD0810N50100AHF](#) [JHS-115-PIN](#)
[DC0710J5005AHF](#) [DC2327J5005AHF](#) [43020](#) [LFB2H2G60BB1C106](#) [LFL15869MTC1B787](#) [X3C19F1-20S](#) [XC3500P-20S](#) [10013-20](#)
[SF2194E](#) [CDBLB455KCAX39-B0](#) [TGL2208-SM, EVAL](#) [RF1353C](#) [051157-0000](#) [PD0922J5050D2HF](#) [1E1305-3](#) [1F1304-3S](#) [1G1304-30](#)
[B0922J7575AHF](#) [10017-3](#) [TP-103-PIN](#) [BD1222J50200AHF](#) [BD1722J50100AHF](#) [2450DP39K5400E](#) [BD0810J50150AHF](#)