

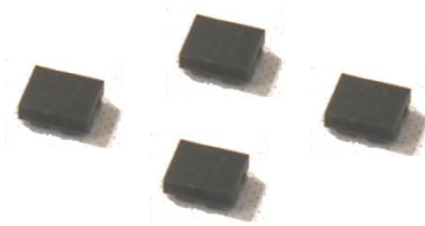

Data Sheet of SAW Components



Note : Murata SAW Component is applicable for Cellular /Cordless phone (Terminal) relevant market only.
Please also read caution at the end of this document.

SAW DPX FOR BAND1

Murata part number :SAYRF1G95HQ0F0A [Tx→ANT]

Package Dimensions

Top View

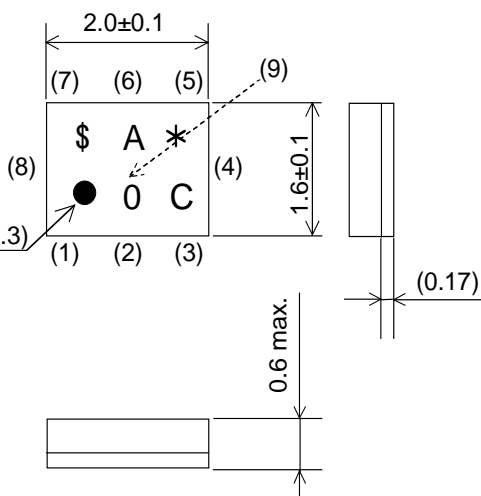

Bottom View

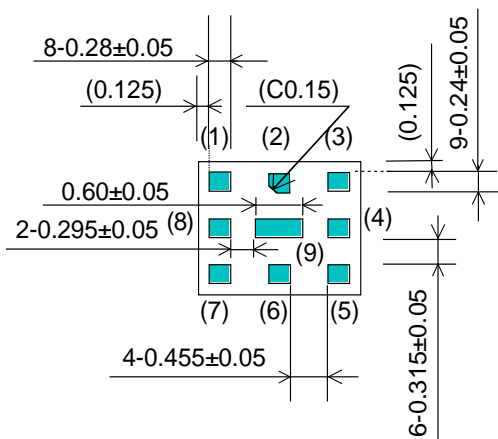

Marking: Laser Printing
 * : EIAJ Code
 (Refer to the table 1)
 \$: Date Code
 (Refer to the table 2)
 (3) : Tx
 (1)(8) : Rx
 (6) : Ant
 Others : Ground

Unit : mm

Target Specification

Item	Target Specification		
	-30 to 85°C	25±2°C	typ.
Nominal Center Frequency(fc)	1950MHz		
Insertion Loss (1920 to 1980MHz) (1922.4 to 1977.6MHz)*	1.7 dB max.	1.6 dB max.	1.3 dB
Absolute Attenuation			
1) 10 to 1574 MHz	30 dB min.	30 dB min.	35 dB
2) 420 to 494 MHz	40 dB min.	40 dB min.	47 dB
3) 843 to 894 MHz	30 dB min.	30 dB min.	38 dB
4) 1565.4 to 1573.4 MHz	43 dB min.	43 dB min.	53 dB
5) 1573.3 to 1577.5 MHz	43 dB min.	43 dB min.	54 dB
6) 1577.4 to 1585.5 MHz	43 dB min.	43 dB min.	55 dB
7) 1597.5 to 1605.9 MHz	43 dB min.	43 dB min.	55 dB
8) 1605.8 to 1805.0 MHz	25 dB min.	25 dB min.	45 dB
9) 1805 to 1865 MHz	25 dB min.	25 dB min.	35 dB
10) 1865 to 1880 MHz	10 dB min.	10 dB min.	35 dB
11) 2110 to 2170 MHz	44 dB min.	44 dB min.	55 dB
12) 2400 to 2500 MHz	40 dB min.	40 dB min.	47 dB
13) 2620 to 2690 MHz	20 dB min.	20 dB min.	41 dB
14) 3830 to 3970 MHz	25 dB min.	25 dB min.	30 dB
15) 5150 to 5950 MHz	18 dB min.	18 dB min.	21 dB
16) 7670 to 7930 MHz	12 dB min.	12 dB min.	17 dB
17) 9590 to 9910 MHz	11 dB min.	11 dB min.	16 dB
Ripple Deviation any 5.0MHz (1920 to 1980MHz)	0.6 dB max.	0.5 dB max.	0.3 dB
VSWR			
1920 to 1980MHz(Tx)	2.0 max.	2.0 max.	1.6
1920 to 1980MHz(ANT)	2.0 max.	2.0 max.	1.6
ANT Port Matching Impedance(nominal)	50Ω/2.3nH(ideal)		
Tx Port Matching Impedance(nominal)	50Ω		
Rx Port Matching Impedance(nominal)	100Ω/12nH(ideal)		
Input Signal Level	+29dBm, 0.8W, 5000h(55°C) (WCDMA modulation)		

* Integration calculation (dB_{INT}):

$$dB_{INT} = 10 \log \left[\frac{\sum_{n=2}^M \left[\frac{(10^{(f_{cns}(f_{n-1})/10)} + 10^{(f_{cns}(f_n)/10)})}{2} \times (F_n - F_{n-1}) \right]}{F_N - F_1} \right]$$

SAW DPX FOR BAND1

Murata part number :SAYRF1G95HQ0F0A [Tx→ANT]

■ Frequency Performance

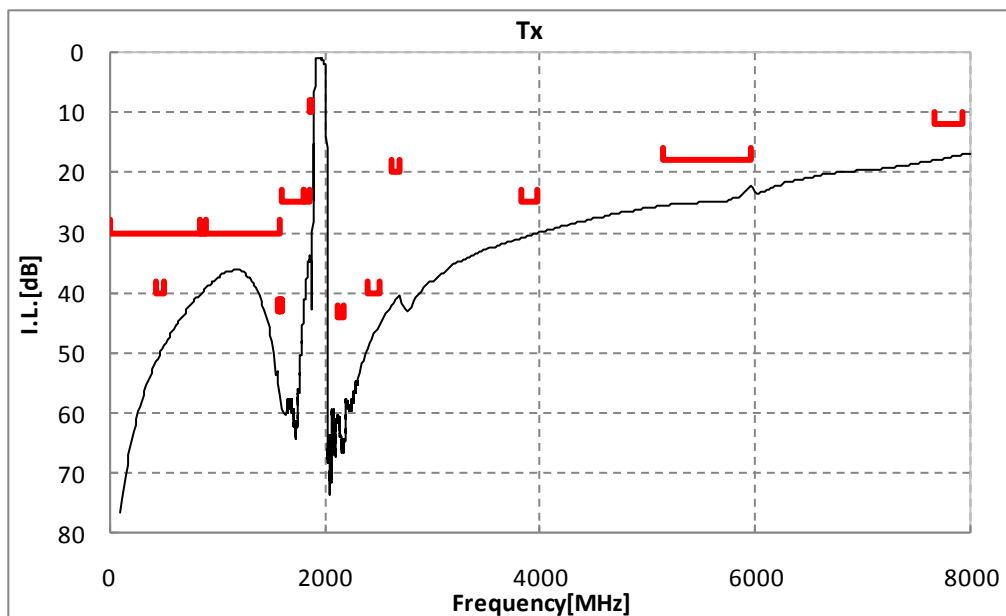
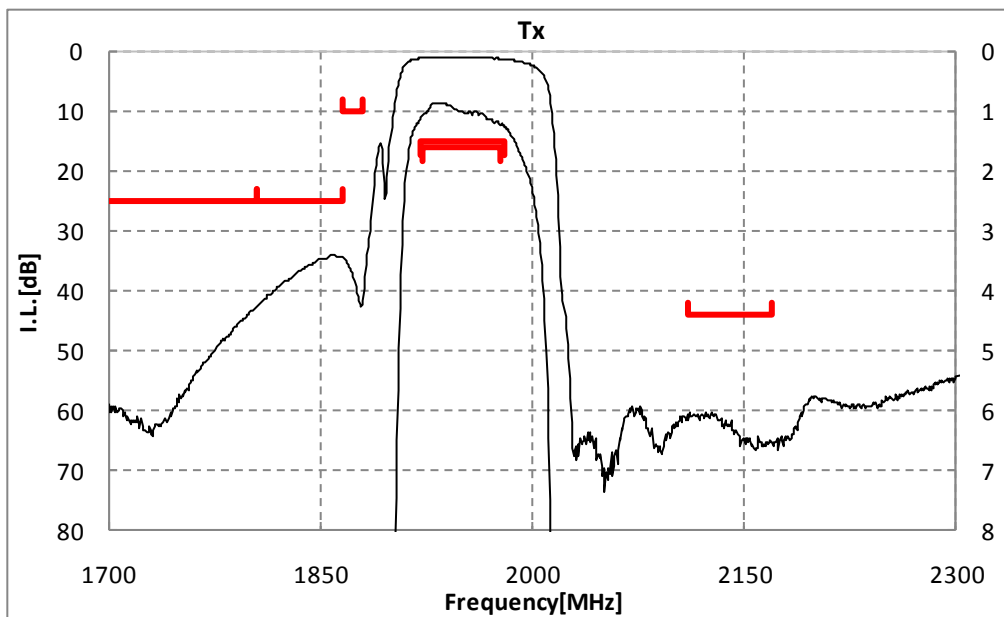

SAW DPX FOR BAND1

Murata part number :SAYRF1G95HQ0F0A [ANT→Rx]

Package Dimensions

Top View

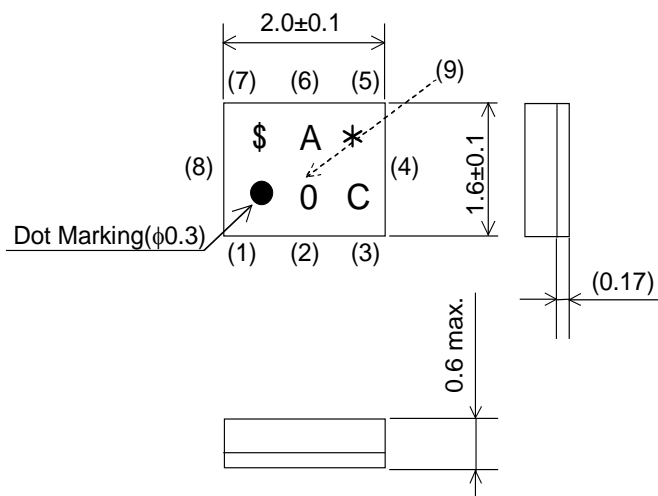

Bottom View

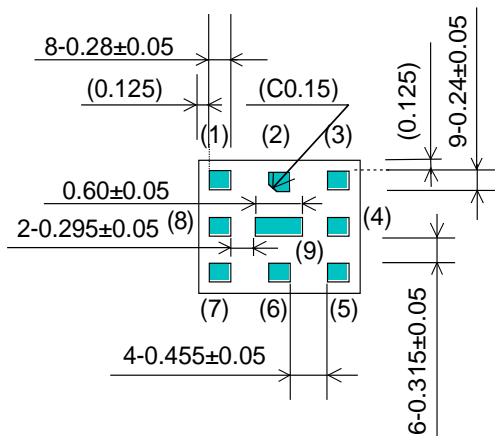

Marking: Laser Printing

* : EIAJ Code

(Refer to the table 1)

\$: Date Code

(Refer to the table 2)

(3) : Tx

(1)(8) : Rx

(6) : Ant

Others : Ground

Unit : mm

Target Specification

Item	Target Specification		
	-30 to 85°C	25±2°C	typ.
Nominal Center Frequency(fc)	2140MHz		
Insertion Loss (2110 to 2170MHz)	2.0 dB max.	1.8 dB max.	1.6 dB
(2112.4 to 2167.6MHz)*	1.9 dB _{INT} max.	1.8 dB _{INT} max.	1.5 dB _{INT}
Absolute Attenuation			
1) 1 to 1920 MHz	30 dB min.	30 dB min.	38 dB
2) 1920 to 1980 MHz	50 dB min.	50 dB min.	64 dB
3) 1980 to 2025 MHz	15 dB min.	15 dB min.	54 dB
4) 2255 to 2400 MHz	15 dB min.	15 dB min.	36 dB
5) 2400 to 2484 MHz	30 dB min.	30 dB min.	36 dB
6) 2484 to 6520 MHz	35 dB min.	35 dB min.	41 dB
Ripple Deviation any 5.0MHz (2110 to 2170MHz)	0.6 dB max.	0.4 dB max.	0.1 dB
Amplitude Balance (2110 to 2170MHz)	±1.0dB max.	±1.0dB max.	0.5 dB
Phase Balance (2110 to 2170MHz)	180±10deg. max.	180±10deg. max.	180-6deg.
VSWR			
2110 to 2170MHz(ANT)	2.0 max.	2.0 max.	1.3
2110 to 2170MHz(Rx)	2.0 max.	2.0 max.	1.3
ANT Port Matching Impedance(nominal)	50Ω/2.3nH(ideal)		
Tx Port Matching Impedance(nominal)	50Ω		
Rx Port Matching Impedance(nominal)	100Ω/12nH(ideal)		

* Integration calculation (dB_{INT}):

$$dB_{INT} = 10 \log \left[\frac{\sum_{n=2}^M \left[\frac{10^{(L_{AS}(f_{n-1})/10)} + 10^{(L_{AS}(f_n)/10)}}{2} \right) \times (F_n - F_{n-1})}{F_M - F_1} \right]$$

SAW DPX FOR BAND1

Murata part number :SAYRF1G95HQ0F0A [ANT→Rx]

Frequency Performance

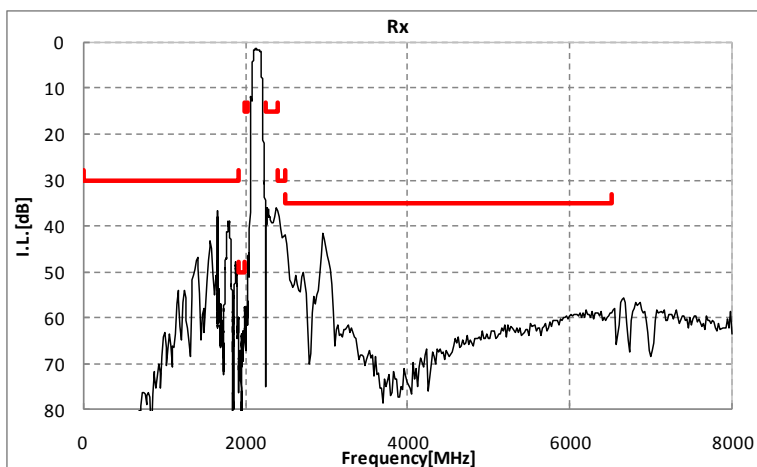
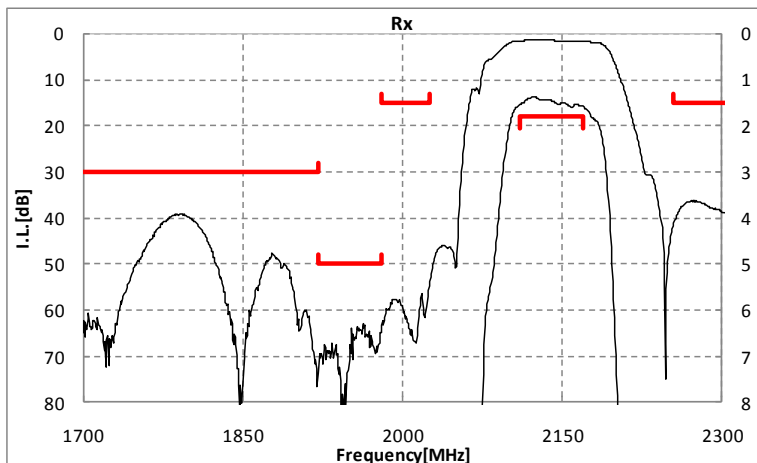

Amplitude Balance

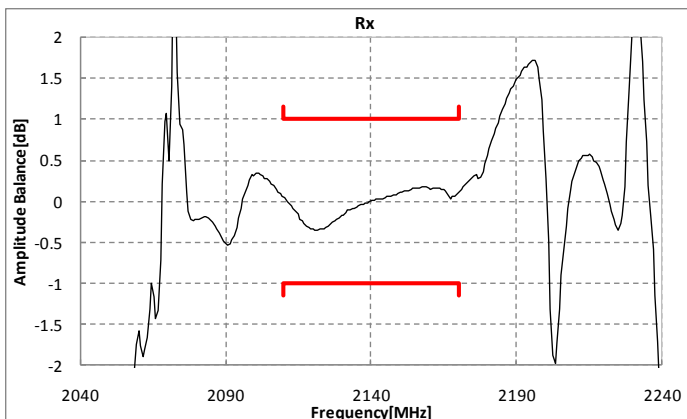

Phase Balance

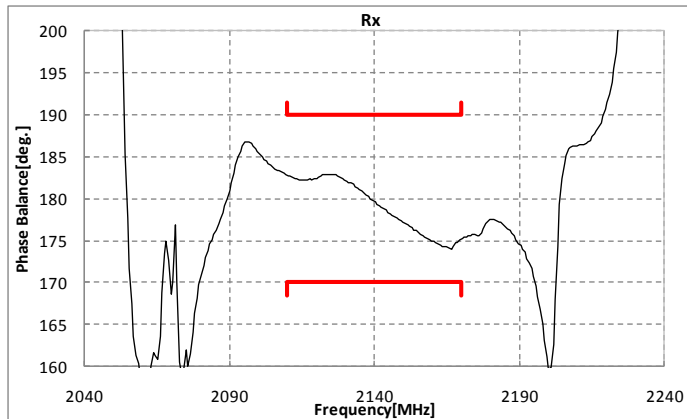

SAW DPX FOR BAND1

Murata part number :SAYRF1G95HQ0F0A [Tx→Rx]

Package Dimensions

Top View

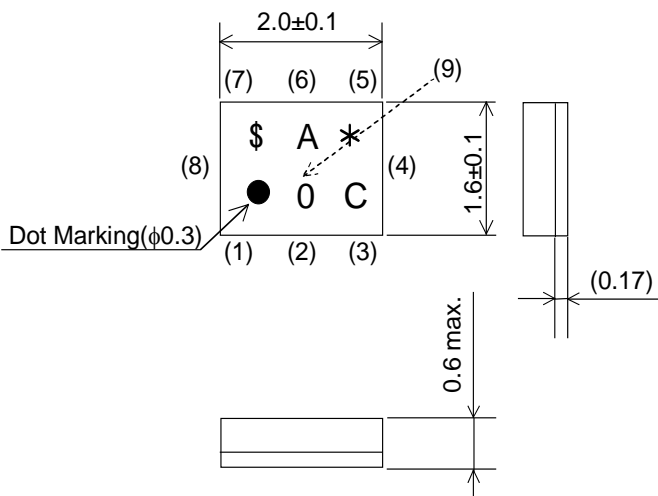

Bottom View

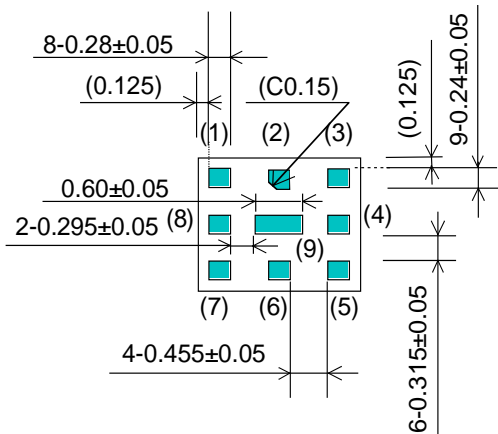

Marking: Laser Printing

* : EIAJ Code

(Refer to the table 1)

\$: Date Code

(Refer to the table 2)

(3) : Tx

(1)(8) : Rx

(6) : Ant

Others : Ground

Unit : mm

Target Specification

item	Target Specification		
	-30 to 85°C	25±2°C	typ.
Isolation (DM)			
1) 1920 to 1980 MHz	55 dB min.	55 dB min.	62 dB
2) 1922.4 to 1977.6 MHz*	55 dB _{INT} min.	55 dB _{INT} min.	62 dB _{INT}
3) 1574 to 1577 MHz	40 dB min.	40 dB min.	68 dB
4) 2110 to 2170 MHz	50 dB min.	50 dB min.	60 dB
5) 2112.4 to 2167.6 MHz*	50 dB _{INT} min.	50 dB _{INT} min.	60 dB _{INT}
6) 3830 to 3970 MHz	20 dB min.	20 dB min.	62 dB
7) 5750 to 5950 MHz	20 dB min.	20 dB min.	57 dB
Isolation (CM)			
1) 1920 to 1980 MHz	53 dB min.	53 dB min.	57 dB
2) 1922.4 to 1977.6 MHz*	53 dB _{INT} min.	53 dB _{INT} min.	57 dB _{INT}

* Integration calculation (dB_{INT}):

$$dB_{INT} = 10 \log \left[\frac{\sum_{n=2}^M \left[\frac{10^{(f_{n-1} - f_n) / 10} + 10^{(f_n - f_{n-1}) / 10}}{2} \right] \times (F_n - F_{n-1})}{F_M - F_1} \right]$$

SAW DPX FOR BAND1

Murata part number :SAYRF1G95HQ0F0A [Tx→Rx]

■ Frequency Performance

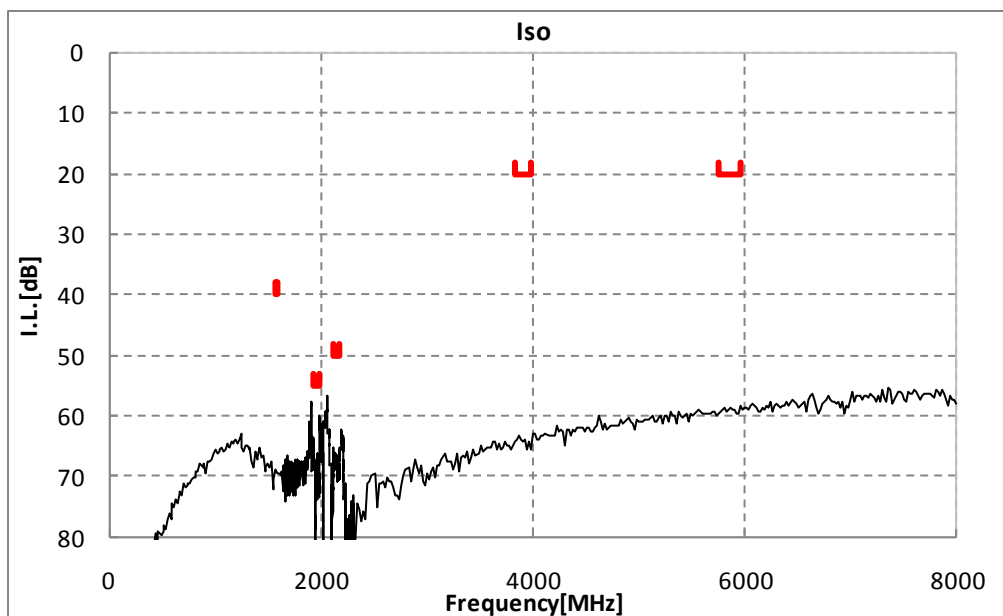
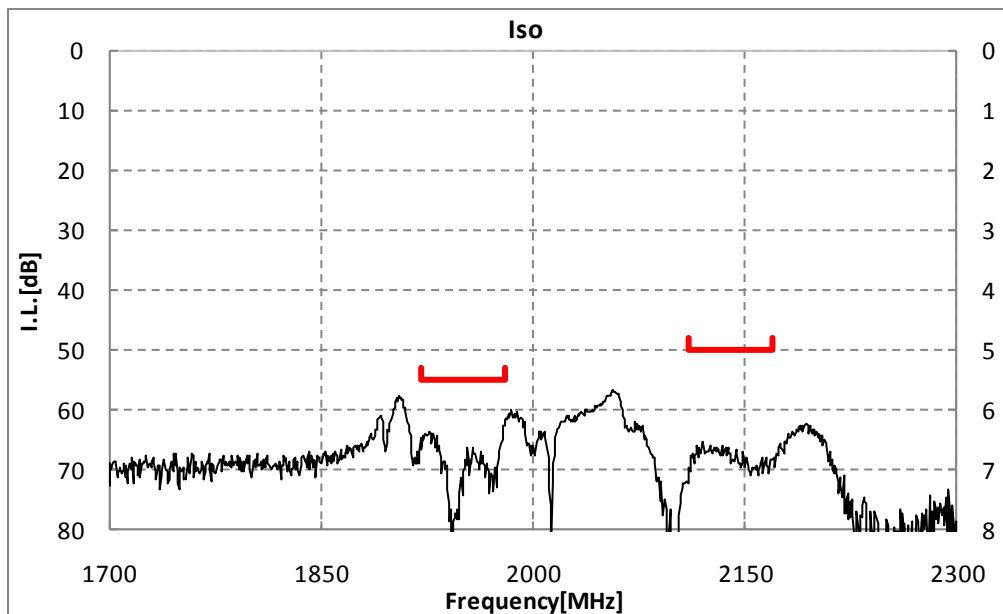

SAW DPX FOR BAND1

Murata part number :SAYRF1G95HQ0F0A

Dimensions of Carrier Tape

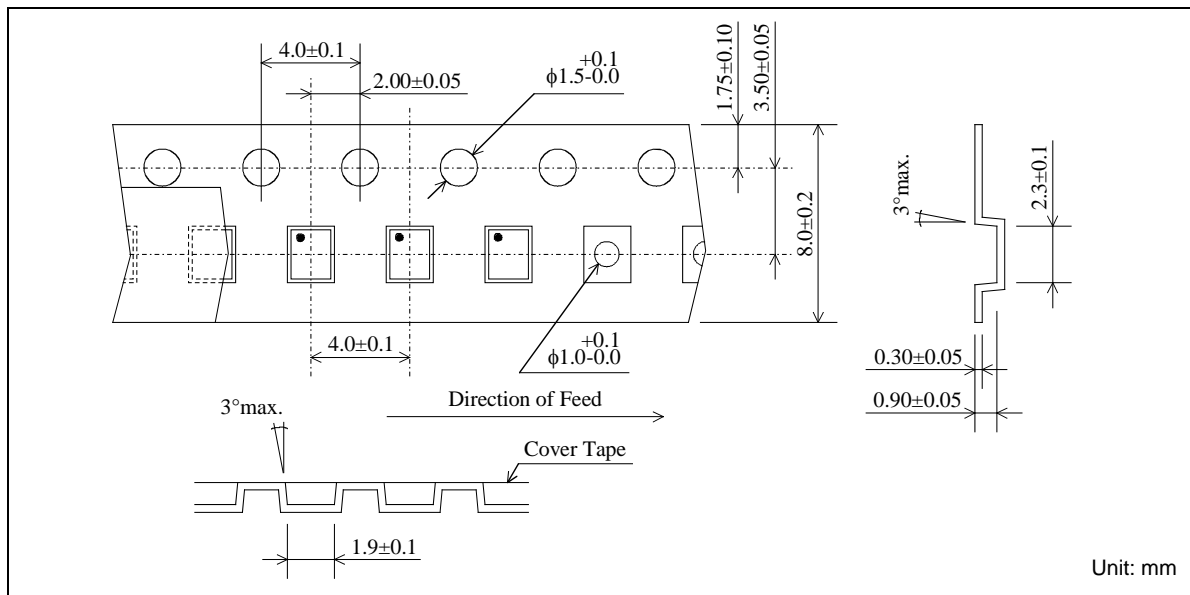

Dimensions of Tape

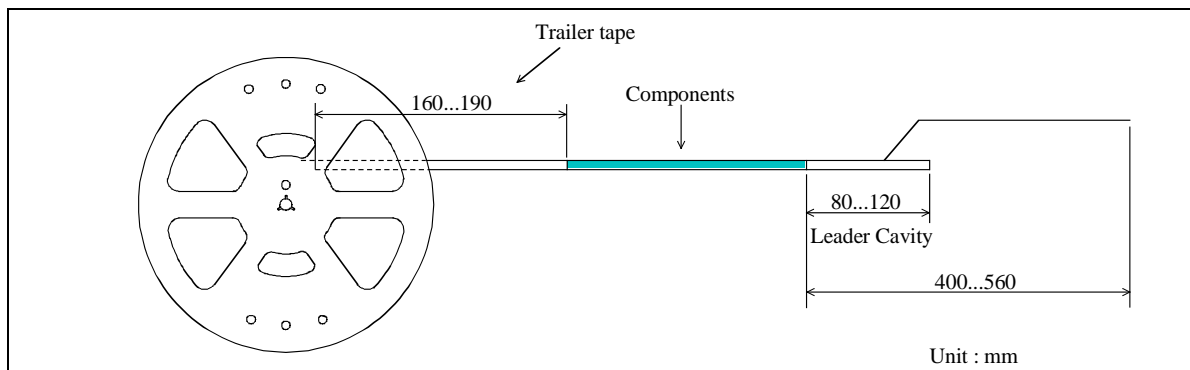

Dimensions of Reel

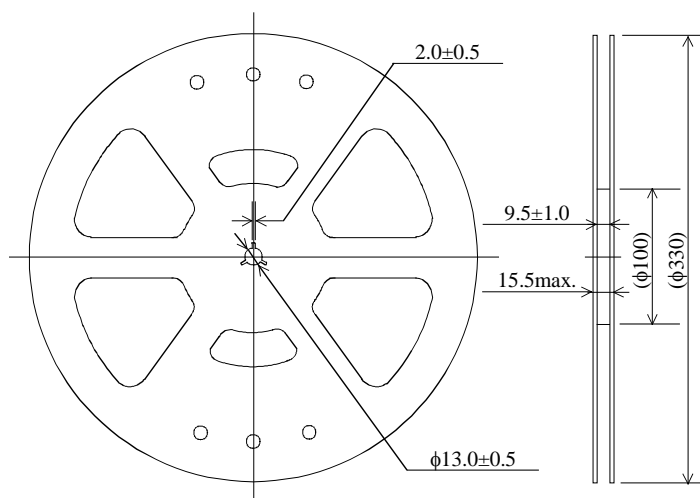

Unit: mm

SAYRF1G95HQ0F0AR00 ... 10000pcs/reel
SAYRF1G95HQ0F0AR05 ... 5000pcs/reel

SAW DPX FOR BAND1

Murata part number :SAYRF1G95HQ0F0A

Recommended Land Pattern

Top View

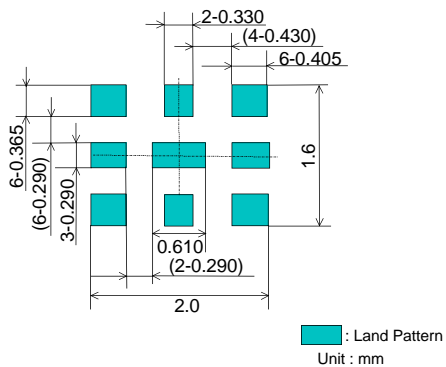

Test Circuit

Bottom View

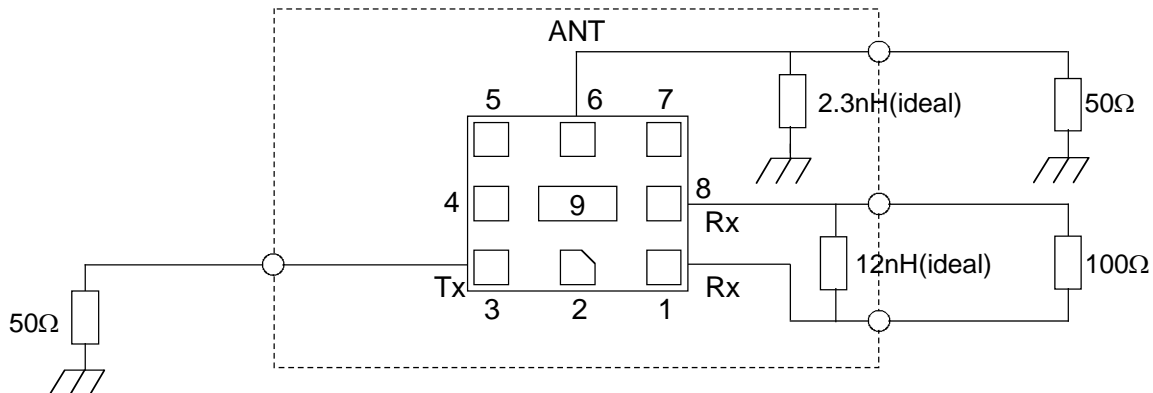

SAW DPX FOR BAND1

Murata part number :SAYRF1G95HQ0F0A

RoHS Compliance

This component is compliant with RoHS directive.
 This component was always RoHS compliant from the first date of manufacture.

• Caution - Limitation of Applications
 This product is intended for the following applications only; however, please do not use this product in these applications where defects might directly cause damage to a third party's life, body or property.

- a. Mobile Telephone
- b. Cordless phone (except for Automotive use)
- c. PC (Including Notebook PC, Netbook PC, Tablet)
- d. Game
- e. Camera (except for Business/security use)
- f. Set Top Box
- g. Electronic dictionary
- h. Digital audio equipment

This catalog is for reference only and not an official product specification document, therefore, please review and approve our official product specification before ordering this product.

Marking code

Table 1 * : EIAJ Code

This rule of code is applied repeatedly every four year.

2009 2013 2017	Jan.	Feb.	Mar.	Apr.	May	Jun.	Jul.	Aug.	Sep.	Oct.	Nov.	Dec.
	A	B	C	D	E	F	G	H	J	K	L	M
2010 2014 2018	Jan.	Feb.	Mar.	Apr.	May	Jun.	Jul.	Aug.	Sep.	Oct.	Nov.	Dec.
	N	P	Q	R	S	T	U	V	W	X	Y	Z
2011 2015 2019	Jan.	Feb.	Mar.	Apr.	May	Jun.	Jul.	Aug.	Sep.	Oct.	Nov.	Dec.
	a	b	c̄	d	e	f	g	h	j	k	l	m
2012 2016 2020	Jan.	Feb.	Mar.	Apr.	May	Jun.	Jul.	Aug.	Sep.	Oct.	Nov.	Dec.
	n	p	q	r	s	t	u	v	w	x	y	z

Table 2 \$: Date Code

date	1st	2nd	3rd	4th	5th	6th	7th	8th	9th	10th	
code	A	B	C	D	E	F	G	H	J	K	
date	11th	12th	13th	14th	15th	16th	17th	18th	19th	20th	
code	L	M	N	P	Q	R	S	T	U	V	
date	21st	22nd	23rd	24th	25th	26th	27th	28th	29th	30th	31st
code	W	X	Y	Z	a	b	c̄	d	e	f	g

SAW DPX FOR BAND1

Murata part number :SAYRF1G95HQ0F0A

■Important notice

PLEASE READ THIS NOTICE BEFORE USING OUR PRODUCTS.

Please make sure that your product has been evaluated and confirmed from the aspect of the fitness for the specifications of our product when our product is mounted to your product.

All the items and parameters in this product specification/datasheet/catalog have been prescribed on the premise that our product is used for the purpose, under the condition and in the environment specified in this specification. You are requested not to use our product deviating from the condition and the environment specified in this specification. Please note that the only warranty that we provide regarding the products is its conformance to the specifications provided herein. Accordingly, we shall not be responsible for any defects in products or equipment incorporating such products, which are caused under the conditions other than those specified in this specification.

WE HEREBY DISCLAIMS ALL OTHER WARRANTIES REGARDING THE PRODUCTS, EXPRESS OR IMPLIED, INCLUDING WITHOUT LIMITATION ANY WARRANTY OF FITNESS FOR A PARTICULAR PURPOSE, THAT THEY ARE DEFECT-FREE, OR AGAINST INFRINGEMENT OF INTELLECTUAL PROPERTY RIGHTS.

The product shall not be used in any application listed below which requires especially high reliability for the prevention of such defect as may directly cause damage to the third party's life, body or property. You acknowledge and agree that, if you use our products in such applications, we will not be responsible for any failure to meet such requirements. Furthermore, YOU AGREE TO INDEMNIFY AND DEFEND US AND OUR AFFILIATES AGAINST ALL CLAIMS, DAMAGES, COSTS, AND EXPENSES THAT MAY BE INCURRED, INCLUDING WITHOUT LIMITATION, ATTORNEY FEES AND COSTS, DUE TO THE USE OF OUR PRODUCTS IN SUCH APPLICATIONS.

- Aircraft equipment.
- Aerospace equipment
- Undersea equipment.
- Power plant control equipment - Medical equipment.
- Transportation equipment (vehicles, trains, ships, elevator, etc.).
- Traffic signal equipment.
- Disaster prevention / crime prevention equipment.
- Burning / explosion control equipment
- Application of similar complexity and/ or reliability requirements to the applications listed in the above.

We expressly prohibit you from analyzing, breaking, Reverse-Engineering, remodeling altering, and reproducing our product. Our product cannot be used for the product which is prohibited from being manufactured, used, and sold by the regulations and laws in the world.

We do not warrant or represent that any license, either express or implied, is granted under any our patent right, copyright, mask work right, or our other intellectual property right relating to any combination, machine, or process in which our products or services are used. Information provided by us regarding third-party products or services does not constitute a license from us to use such products or services or a warranty or endorsement thereof. Use of such information may require a license from a third party under the patents or other intellectual property of the third party, or a license from us under our patents or other intellectual property.

Please do not use our products, our technical information and other data provided by us for the purpose of developing of mass-destruction weapons and the purpose of military use. Moreover, you must comply with "foreign exchange and foreign trade law", the "U.S. export administration regulations", etc.

Please note that we may discontinue the manufacture of our products, due to reasons such as end of supply of materials and/or components from our suppliers.

SAW DPX FOR BAND1

Murata part number :SAYRF1G95HQ0F0A

Customer acknowledges that Murata will, if requested by you, conduct a failure analysis for defect or alleged defect of Products only at the level required for consumer grade Products, and thus such analysis may not always be available or be in accordance with your request (for example, in cases where the defect was caused by components in Products supplied to Murata from a third party).

The product shall not be used in any other application/model than that of claimed to Murata.

Customer acknowledges that engineering samples may deviate from specifications and may contain defects due to their development status.

We reject any liability or product warranty for engineering samples.

In particular we disclaim liability for damages caused by

- the use of the engineering sample other than for evaluation purposes, particularly the installation or integration in the product to be sold by you,
- deviation or lapse in function of engineering sample,
- improper use of engineering samples.

We disclaims any liability for consequential and incidental damages.

If you can't agree the above contents, you should inquire our sales.

X-ON Electronics

Largest Supplier of Electrical and Electronic Components

Click to view similar products for [Signal Conditioning](#) category:

Click to view products by [Murata](#) manufacturer:

Other Similar products are found below :

[MAPDCC0004](#) [PD0409J5050S2HF](#) [HHS-109-PIN](#) [AFS14A35-1591.50-T3](#) [DS-323-PIN](#) [DSS-313-PIN](#) [1A0220-3](#) [JP510S](#)

[LFB212G45SG8C341](#) [LFB322G45SN1A504](#) [LFL182G45TC3B746](#) [SF2159E](#) [30057](#) [AFS1575.42S4-T](#) [FM-104-PIN](#) [CER0813B](#)

[MAPDCC0005](#) [3A325](#) [40287](#) [BD0810N50100AHF](#) [JHS-115-PIN](#) [DC0710J5005AHF](#) [DC2327J5005AHF](#) [43020](#) [LFB2H2G60BB1C106](#)

[LFL15869MTC1B787](#) [X3C19F1-20S](#) [XC3500P-20S](#) [10013-20](#) [SF2194E](#) [CDBLB455KCAX39-B0](#) [RF1353C](#) [051157-0000](#)

[PD0922J5050D2HF](#) [1E1305-3](#) [1F1304-3S](#) [1G1304-30](#) [B0922J7575AHF](#) [10017-3](#) [TP-103-PIN](#) [BD1222J50200AHF](#) [BD1722J50100AHF](#)

[2450DP39K5400E](#) [BD0810J50150AHF](#) [BD1722J50200AHF](#) [DSS-113-PIN](#) [DS-327-PIN](#) [MACP-008125-CK07F0](#) [DS-329-PIN](#) [DS-313-PIN](#)