

**SF1192B**

**1842.5 MHz  
SAW Filter**

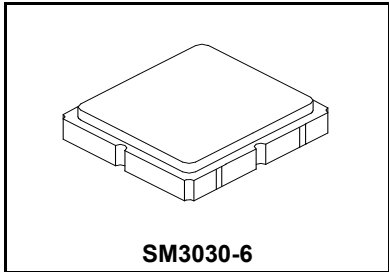

- RF Filter for Mobile Communication Applications
- No Matching Circuit Required
- 3.0 x 3.0 x 1.3 mm Package
- Complies with Directive 2011/65/EU (RoHS)



**Absolute Maximum Ratings**

Rating	Value	Units
Maximum Input Power	+10	dBm
DC voltage between Terminals	0	VDC
Operable Temperature Range	-45 to +125	°C
Storage Temperature	-40 to +85	°C
Suitable for lead-free soldering - Max Soldering Temperature	260°C for 30 s	

**Electrical Characteristics**

Characteristic	Sym	Notes	Min	Typ	Max	Units
Nominal Operating Frequency	$f_c$			1842.5		MHz
Passband	Insertion Loss across $f_c \pm 37.5$ MHz			2.2	3.8	dB
		Amplitude Ripple p-p across $f_c \pm 37.5$ MHz		1.3	2.3	dB
Attenuation		1542.5 ~ 1600 MHz	20.0	24.5		dB
		1600 ~ 1710 MHz	22.0	25.0		dB
		1710 ~ 1785 MHz	10.0	23.5		dB
		1920 ~ 2142.5 MHz	25.0	28.0		dB
VSWR across $f_c \pm 37.5$ MHz				1.9	2.6	
Source impedance	$Z_s$			50		$\Omega$
Load impedance	$Z_L$			50		$\Omega$
Specification Temperature Range	$T_A$		-30		+85	°C

Case Style	SM3030-6 3 x 3 mm Nominal Footprint
Lid Symbolization (Y=year, WW=week, S=Shift)	454 YWWS
Standard Reel Quantity	500 Pieces Per Reel
Reel Size 7 Inch	
Reel Size 13 Inch	3000 Pieces Per Reel

**Electrical Connections**

Connection	Terminals
Input	2
Output	5
Ground	All others

 **CAUTION: Electrostatic Sensitive Device. Observe precautions for handling.**

**NOTES:**

1. Unless noted otherwise, all specifications apply over the operating temperature range with filter soldered to the specified demonstration board with impedance matching to 50  $\Omega$  and measured with 50  $\Omega$  network analyzer.
2. Unless noted otherwise, all frequency specifications are referenced to the nominal center frequency,  $f_c$ .
3. The design, manufacturing process, and specifications of this filter are subject to change.
4. Either Port 1 or Port 2 may be used for either input or output in the design. However, impedances and impedance matching may vary between Port 1 and Port 2, so that the filter must always be installed in one direction per the circuit design.
5. US and international patents may apply.
6. Murata, stylized Murata logo, and Murata N.A., Inc. are registered trademarks of Murata Manufacturing Co., Ltd

**Frequency Characteristics:  
Transfer Function**

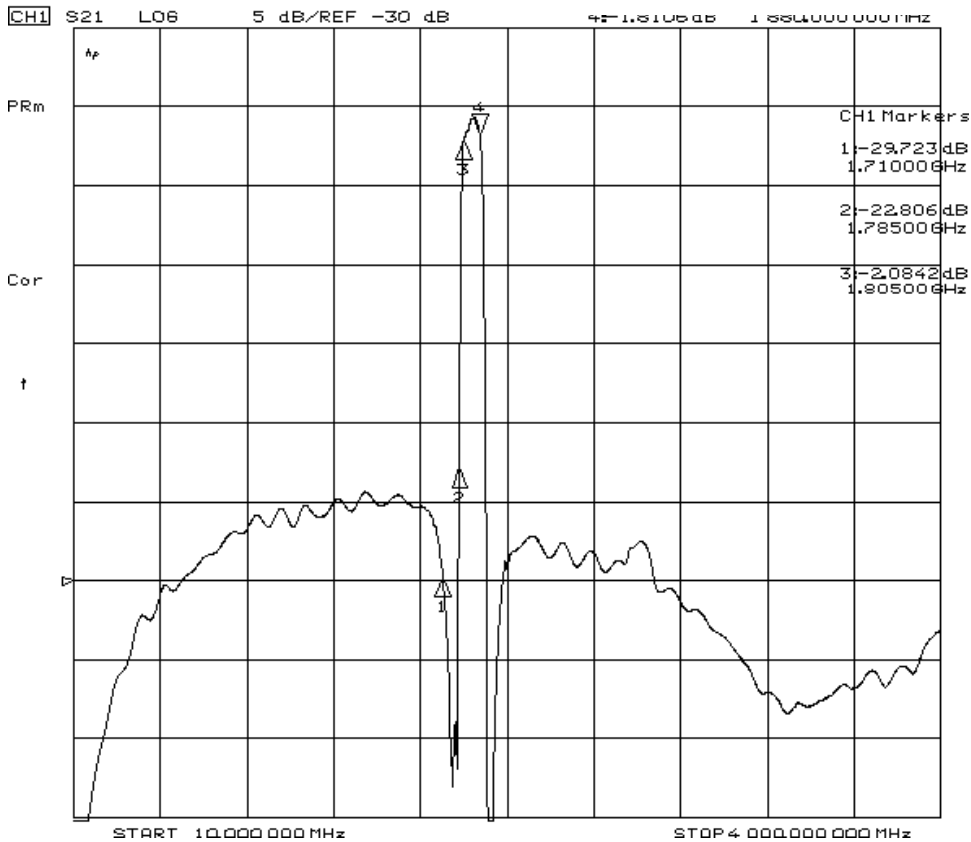
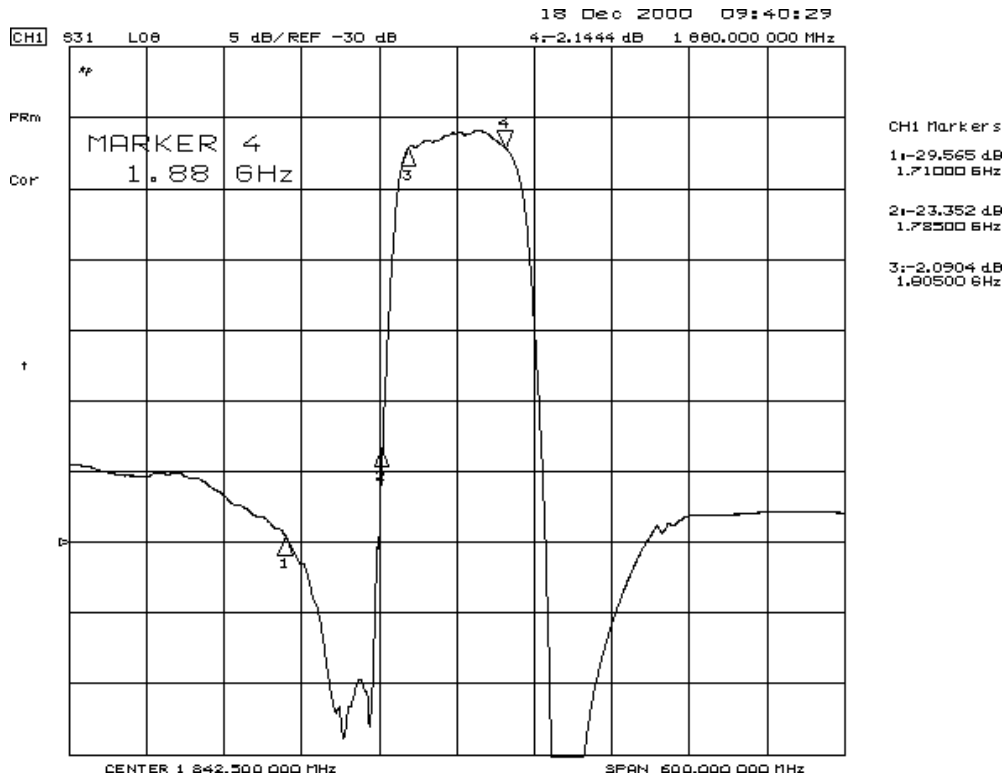

Reflections Functions:

S11 VSWR

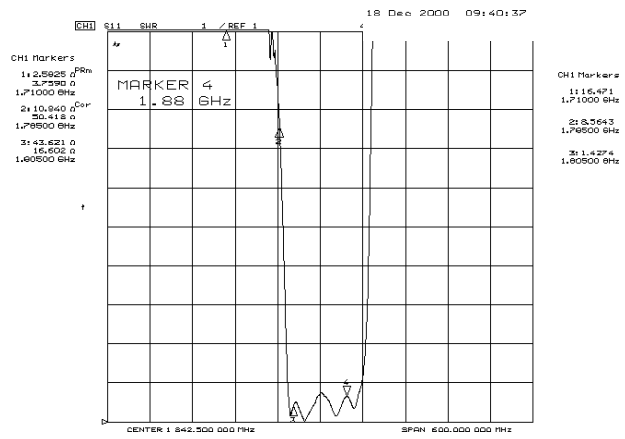
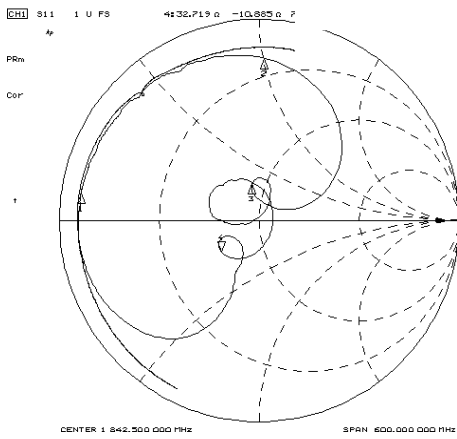

S22 VSWR

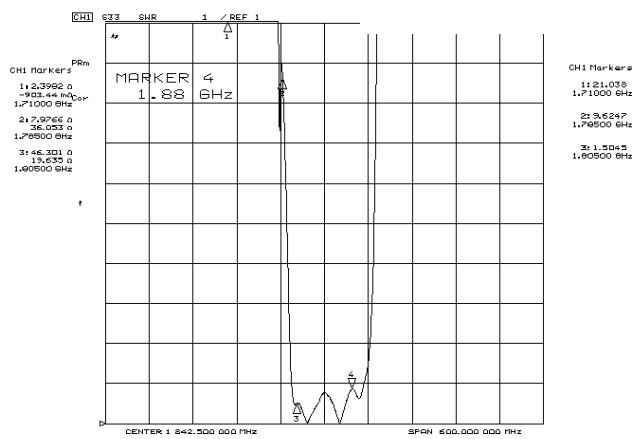
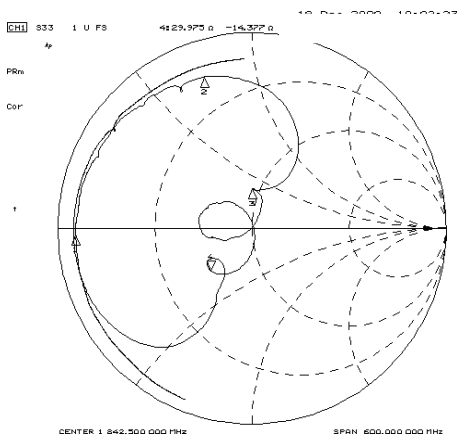

# Tape and Reel Specifications

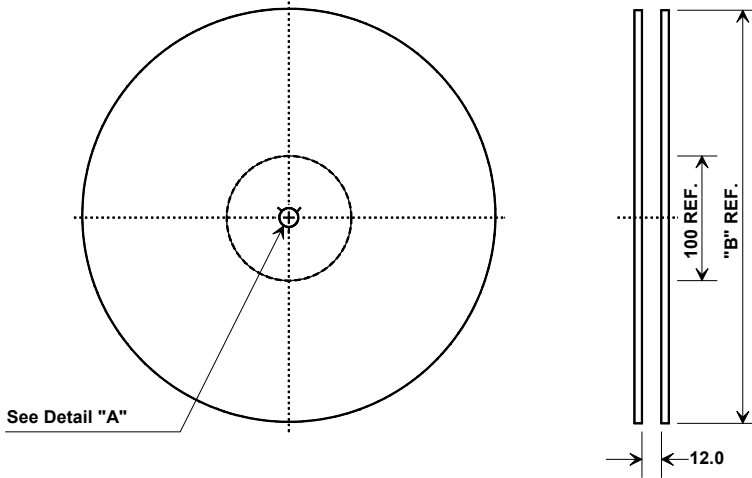

"B" Nominal Size		Quantity Per Reel
Inches	millimeters	
7	178	500
13	330	3000

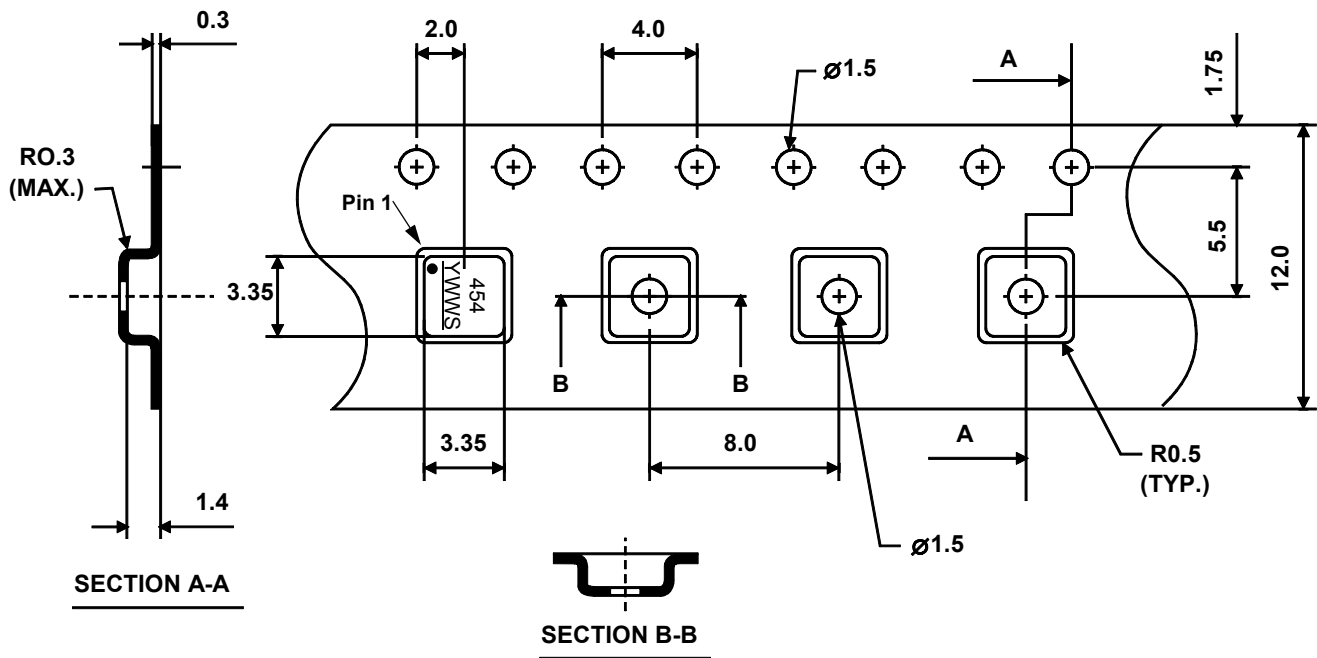
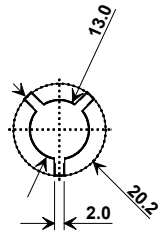

# SM3030-6 Case

## 6-Terminal Ceramic Surface-Mount Case 3.0 X 3.0 mm Nominal Footprint

### Case Dimensions

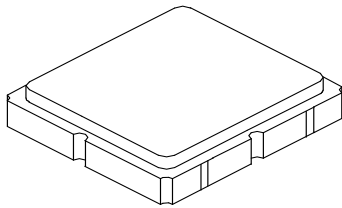

Dimension	mm			Inches		
	Min	Nom	Max	Min	Nom	Max
A	2.87	3.00	3.13	0.113	0.118	0.123
B	2.87	3.00	3.13	0.113	0.118	0.123
C	1.12	1.25	1.38	0.044	0.049	0.054
D	0.77	0.90	1.03	0.030	0.035	0.040
E	2.67	2.80	2.93	0.105	0.110	0.115
F	1.47	1.60	1.73	0.058	0.063	0.068
G	0.72	0.85	0.98	0.028	0.033	0.038
H	1.37	1.50	1.63	0.054	0.059	0.064
I	0.47	0.60	0.73	0.019	0.024	0.029
J	1.17	1.30	1.43	0.046	0.051	0.056

### Electrical Connections

Connection		Terminals
Port 1	Single Ended Input	2
Port 2	Single Ended Output	5
	Ground	All others
<b>Single Ended Operation Only</b>		
Dot indicates Pin 1		

TOP VIEW

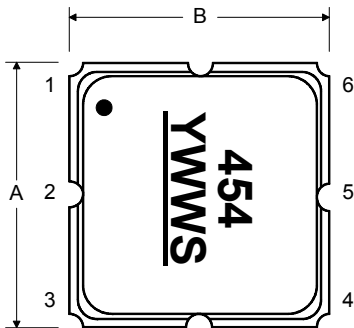

BOTTOM VIEW

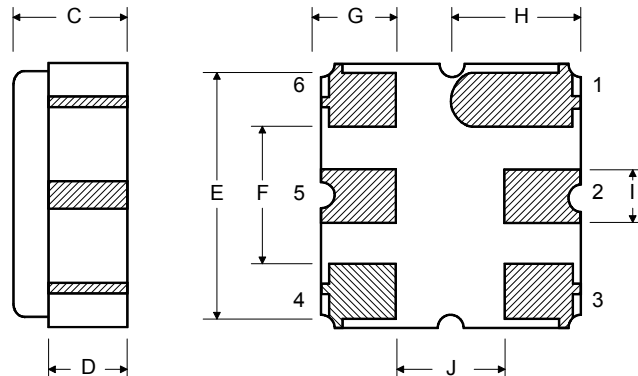

## X-ON Electronics

Largest Supplier of Electrical and Electronic Components

*Click to view similar products for [Signal Conditioning](#) category:*

*Click to view products by [Murata](#) manufacturer:*

Other Similar products are found below :

[MAPDCC0001](#) [MAPDCC0004](#) [PD0409J5050S2HF](#) [880157](#) [HHS-109-PIN](#) [DC1417J5005AHF](#) [AFS14A30-2185.00-T3](#) [AFS14A35-1591.50-T3](#) [DS-323-PIN](#) [B39321R801H210](#) [1A0220-3](#) [JP510S](#) [LFB212G45SG8C341](#) [LFB322G45SN1A504](#) [LFL182G45TC3B746](#) [SF2159E](#) [30057](#) [FM-104-PIN](#) [CER0813B](#) [MAPDCC0005](#) [3A325](#) [40287](#) [41180](#) [ATB3225-75032NCT](#) [BD0810N50100AHF](#) [BD2425J50200AHF](#) [C5060J5003AHF](#) [JHS-115-PIN](#) [JP503AS](#) [DC0710J5005AHF](#) [DC2327J5005AHF](#) [DC3338J5005AHF](#) [43020](#) [LFB2H2G60BB1C106](#) [LFL15869MTC1B787](#) [X3C19F1-20S](#) [XC3500P-20S](#) [10013-20](#) [SF2194E](#) [CDBLB455KCAX39-B0](#) [TGL2208-SM, EVAL](#) [RF1353C](#) [1E1305-3](#) [1F1304-3S](#) [1G1304-30](#) [B0922J7575AHF](#) [2020-6622-20](#) [TP-102-PIN](#) [TP-103-PIN](#) [BD1222J50200AHF](#)