

SF2182D

**140 MHz
SAW Filter**

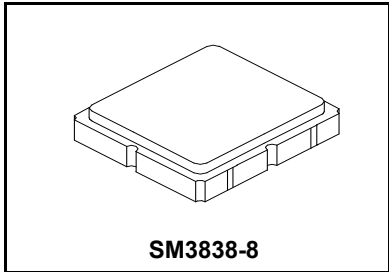

- Precision 140 MHz SAW Filter
- 22 MHz Bandwidth
- 3.8 x 3.8 x 1.4 mm Surface-mount Package
- Complies with Directive 2002/95/EC (RoHS)



Absolute Maximum Ratings

Rating	Value	Units
Maximum Incident Power in Passband	+10	dBm
Maximum DC Voltage on any Non-ground Terminal	3	VDC
Storage Temperature Range in Tape and Reel	-40 to +85	°C
Suitable for Lead-free Soldering - Maximum Soldering Profile	260 °C for 30 s	

Electrical Characteristics

Characteristic	Sym	Notes	Min	Typ	Max	Units
Nominal Center Frequency	F_C	1		140		MHz
Insertion Loss	IL_{MAX}	1		13.5	15.0	dB
Insertion Loss Variation over Temperature		1			1	dB
3 dB Bandwidth		1	40	43		MHz
Passband Amplitude Ripple, Single-ended Matching, 120 to 160 MHz		1		0.8	1.5	dB _{P-P}
Passband Amplitude Ripple, Balanced Matching, 120 to 160 MHz		1		1.2	2.0	dB _{P-P}
Attenuation Referenced to IL_{MAX}						
10 to 70 MHz		3	45	50		dB
70 to 115 MHz		3	25	40		
166.5 to 200 MHz		3	25	40		
200 to 400 MHz		3	45	50		
Absolute Group Delay in Passband		1		400	450	ns
Passband Group Delay Ripple, Matching Network A or B, 129 to 151 MHz		1		20	50	ns _{P-P}
Input Impedance, Unbalanced Matching Network		1		50		ohm
Input Impedance, Balanced Matching Network		1		200		ohm
Input Return Loss through any Matching Network		1	3	8		dB
Output Impedance, Unbalanced Matching Network		1		50		ohm
Output Impedance, Balanced Matching Network		1		200		ohm
Output Return Loss through any Matching Network		1	3	10		dB
Operating Temperature Range			-40		+85	°C
Case Style			SM3838-8 3.8 x 3.8 mm Nominal Footprint			
Lid Symbolization, Y=year, WW=week, S=shift			RFM 873 YWWS			



CAUTION: Electrostatic Sensitive Device. Observe precautions for handling.

NOTES:

1. Unless noted otherwise, all specifications apply over the operating temperature range with filter soldered to the specified demonstration board with impedance matching to 50 Ω and measured with 50 Ω network analyzer.
2. Unless noted otherwise, all frequency specifications are referenced to the nominal center frequency, f_c .
3. Rejection in final user application is dependent on PCB layout and external impedance matching design. See Application Note No. 42 for details.
4. "LRIP" or "L" after the part number indicates "low rate initial production" and "ENG" or "E" indicates "engineering prototypes."
5. The design, manufacturing process, and specifications of this filter are subject to change.
6. Either Port 1 or Port 2 may be used for either input or output in the design. However, impedances and impedance matching may vary between Port 1 and Port 2, so that the filter must always be installed in one direction per the circuit design.
7. US and international patents may apply.
8. Murata, stylized Murata logo, and Murata N.A., Inc. are registered trademarks of Murata Manufacturing Co., Ltd.

SF2182D, Single-ended Matching

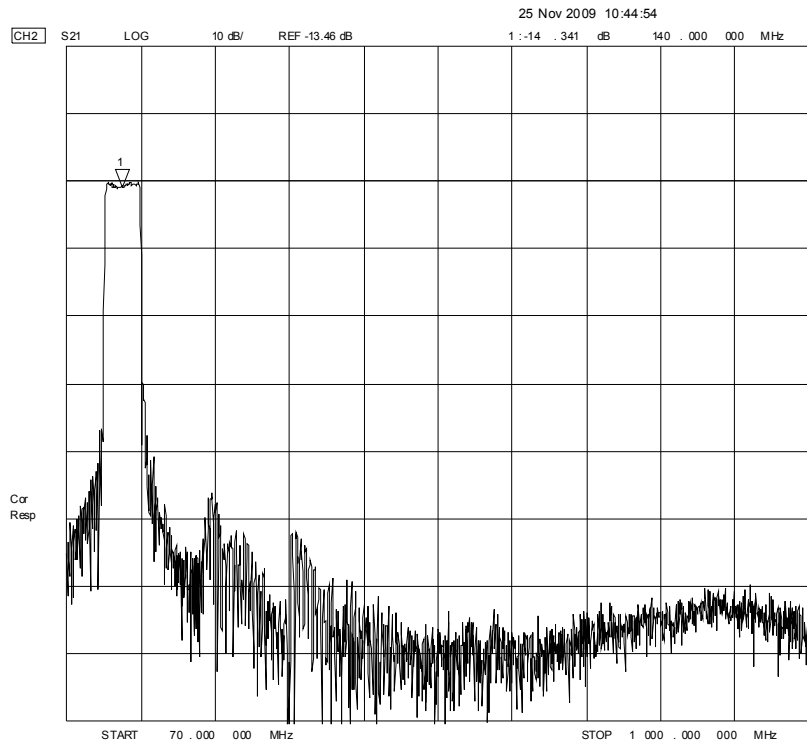
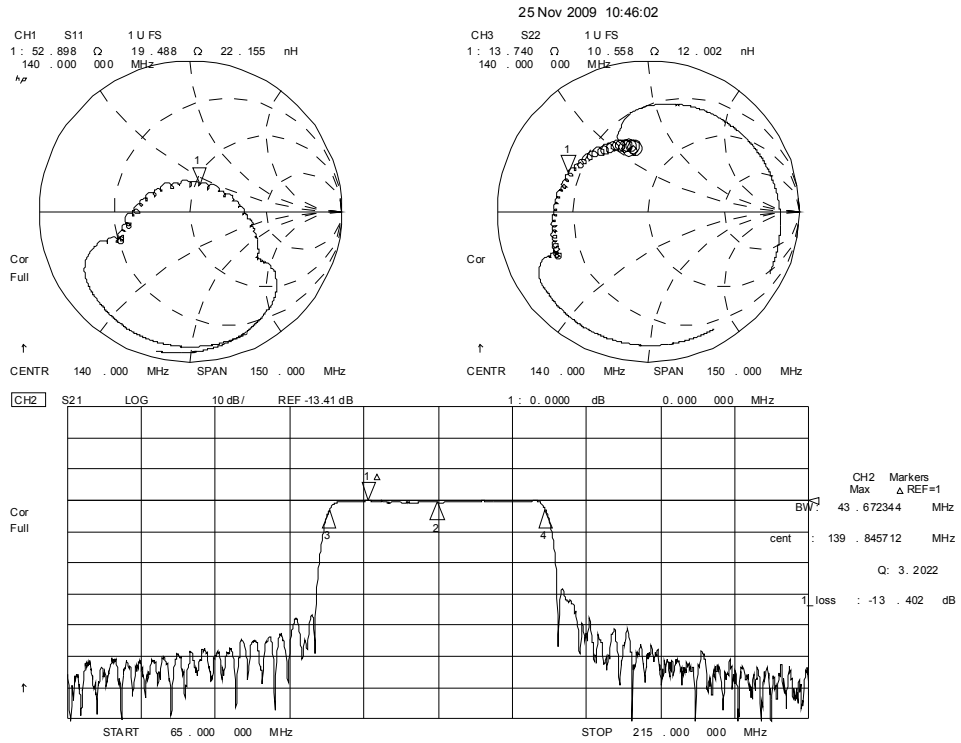

25 Nov 2009 10:48:26

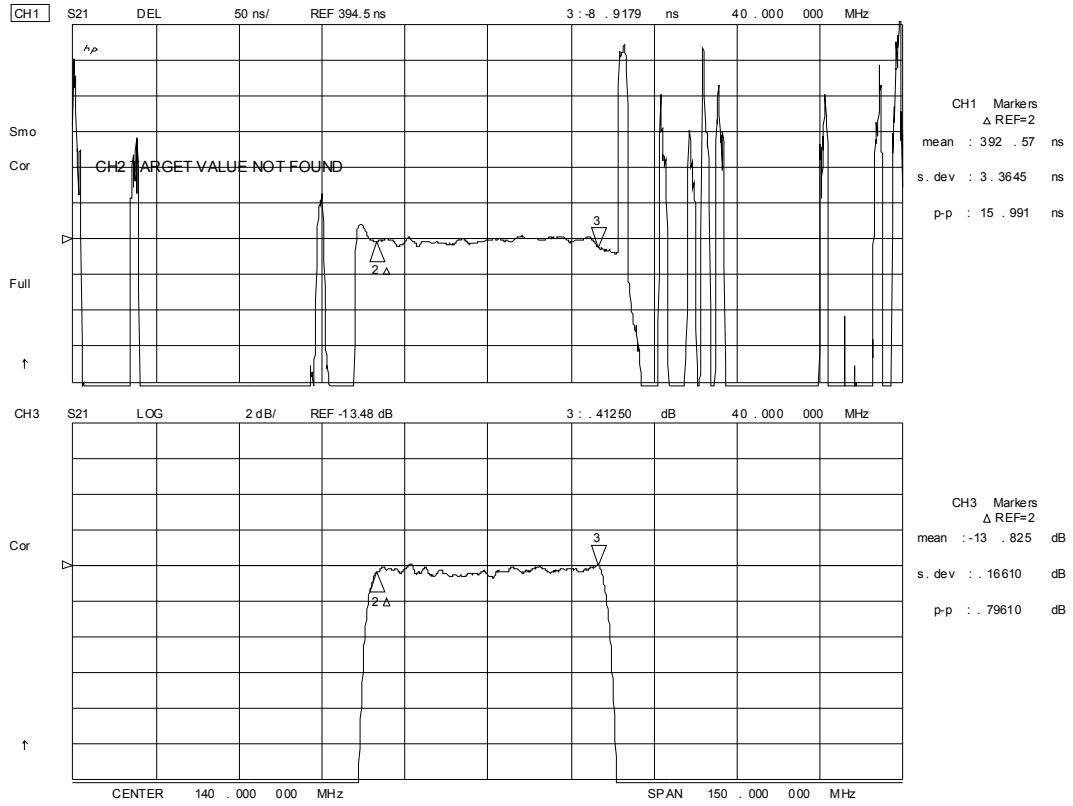

SF2182D Single-ended Test Circuit

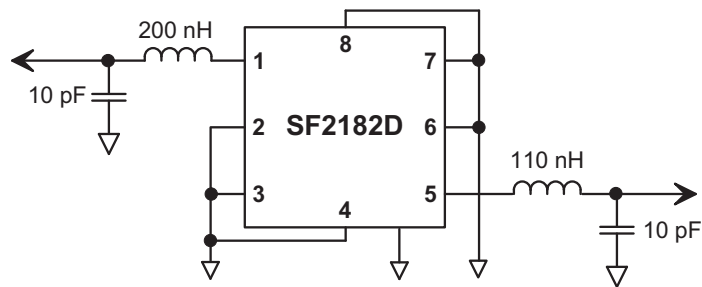

SF2182D, Balanced Input Matching

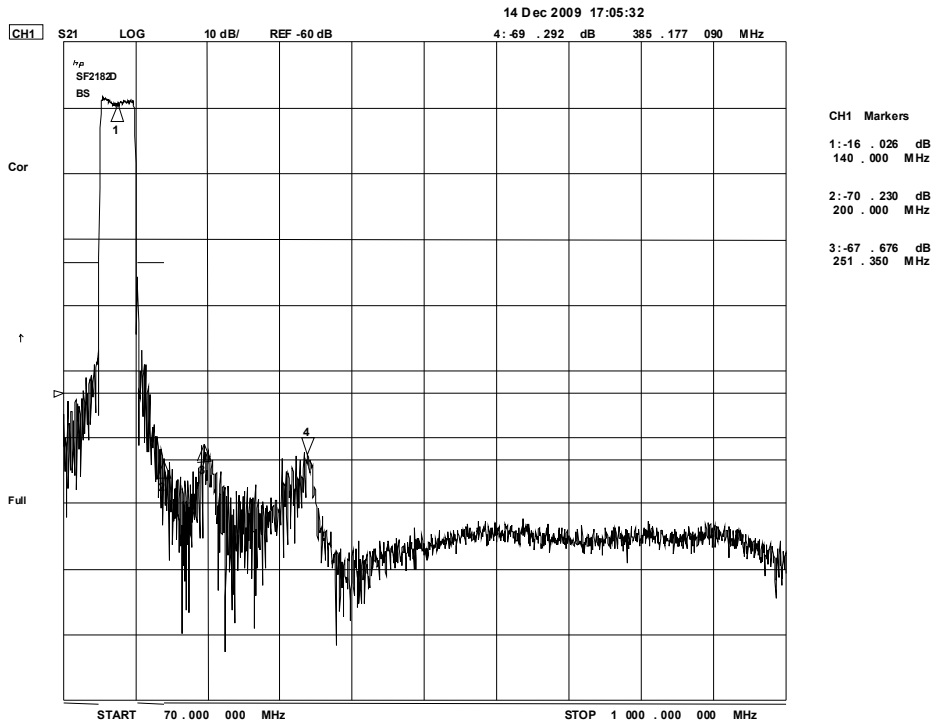
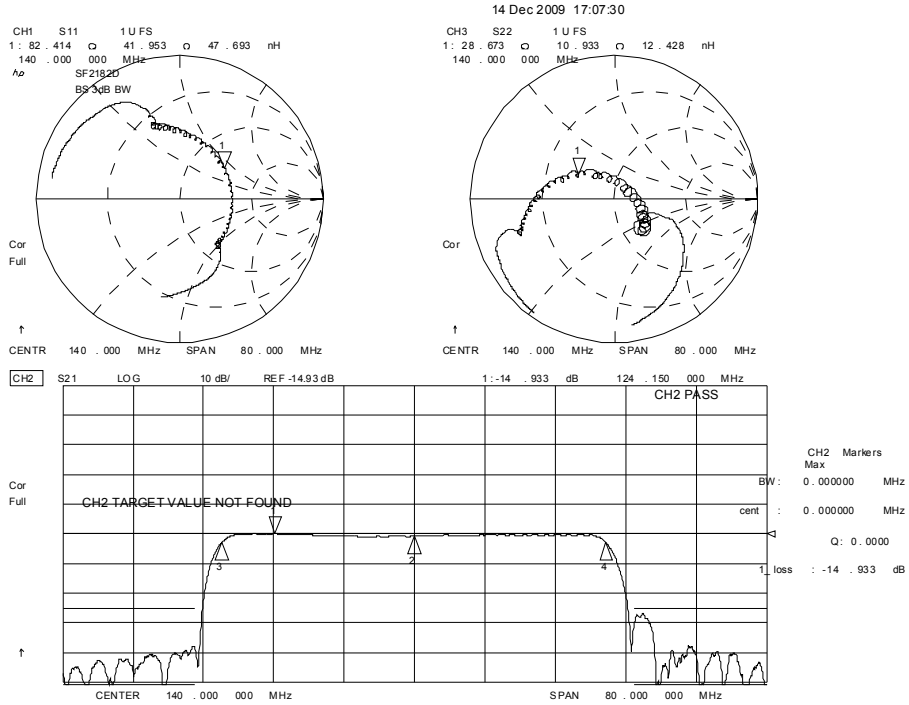

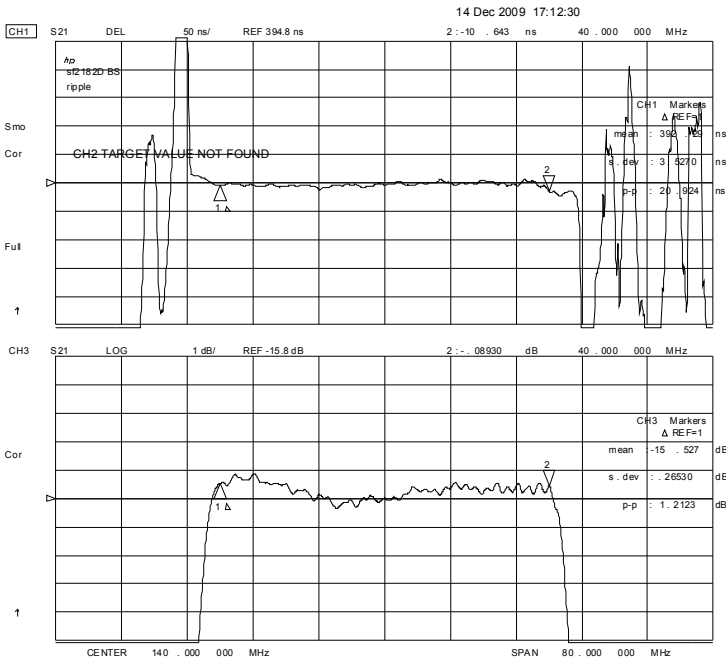
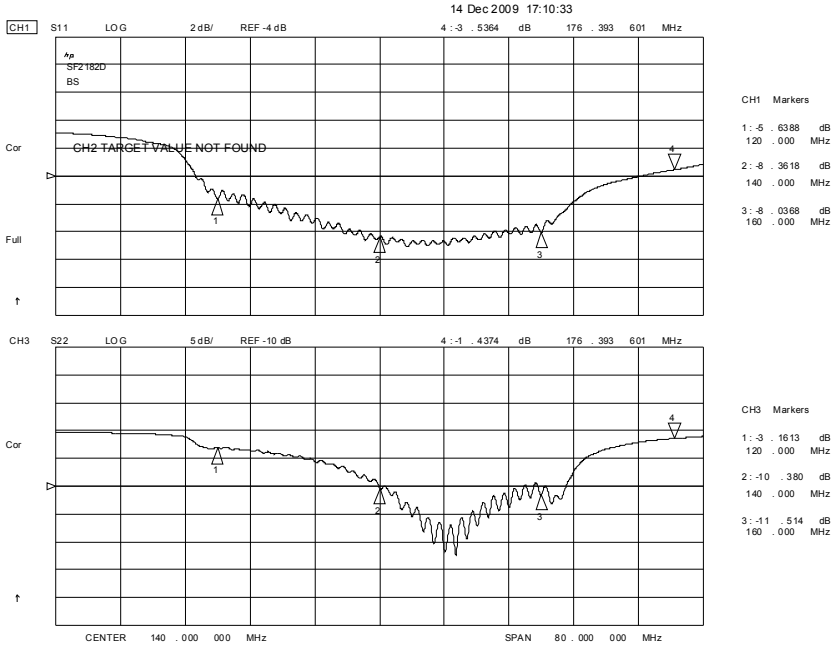

SF2182D, Balanced Input Matching Network

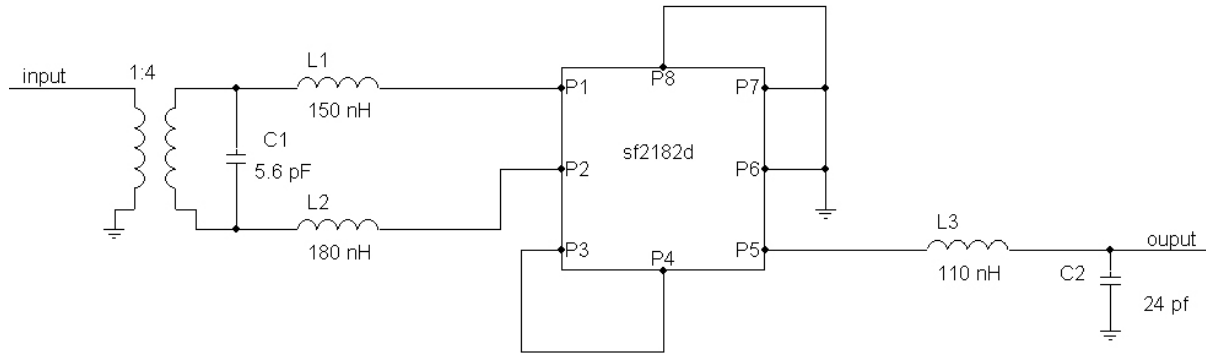

SF2182D, Balanced Output Matching

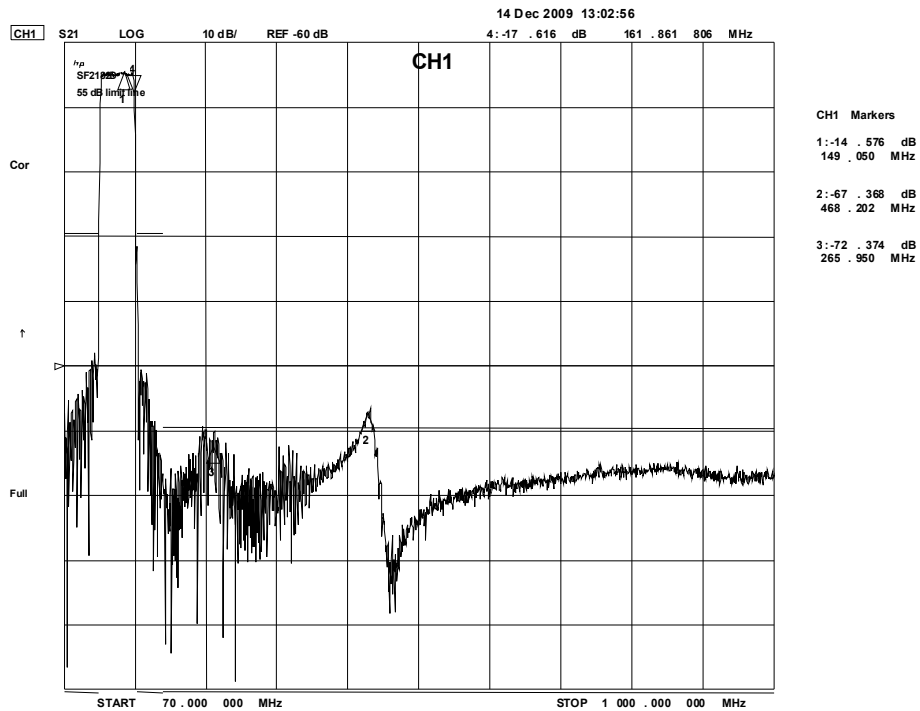
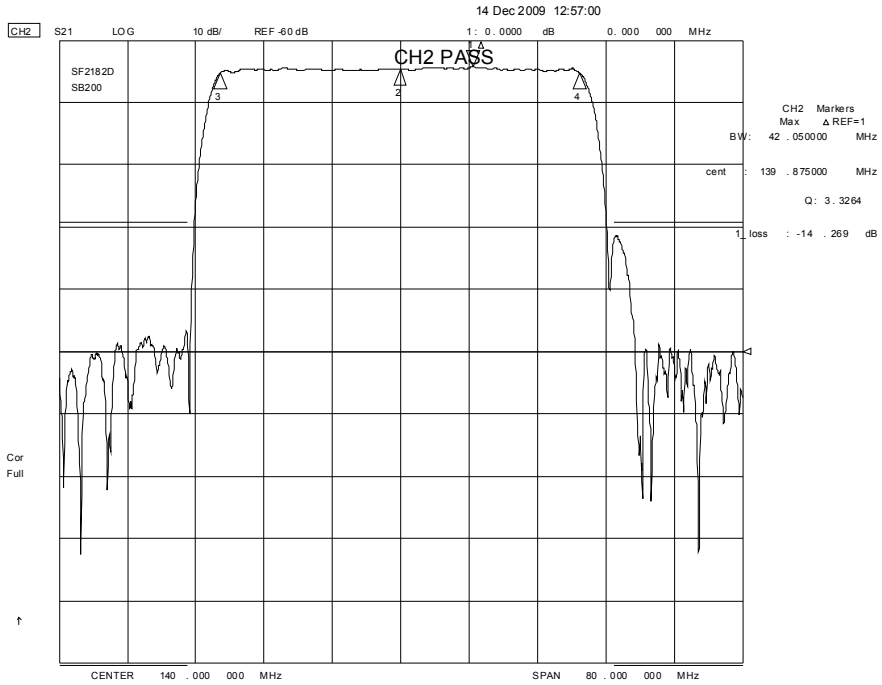

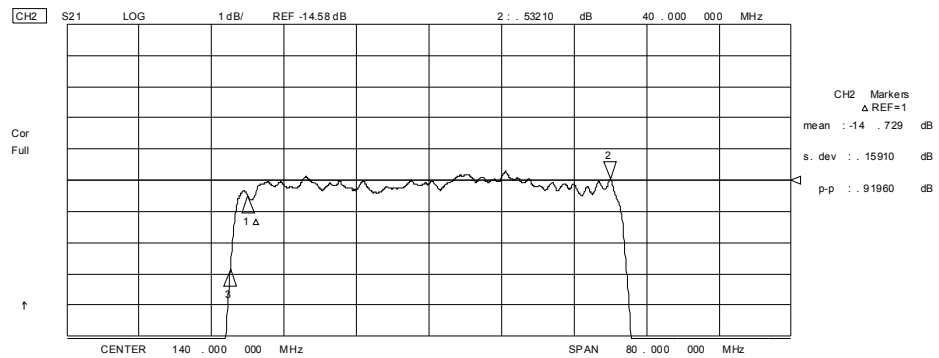
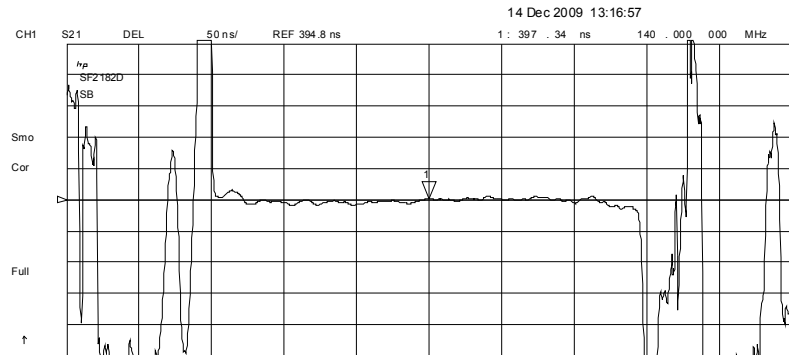
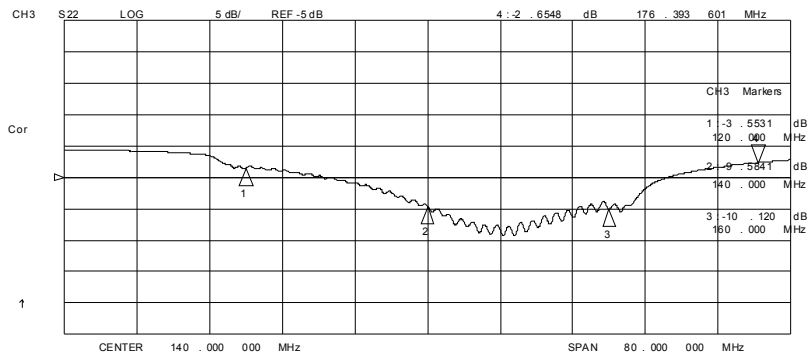
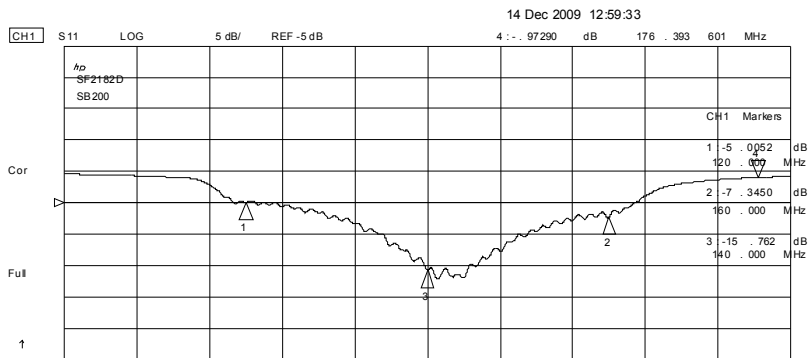

SF2182D, Balanced Output Matching Network

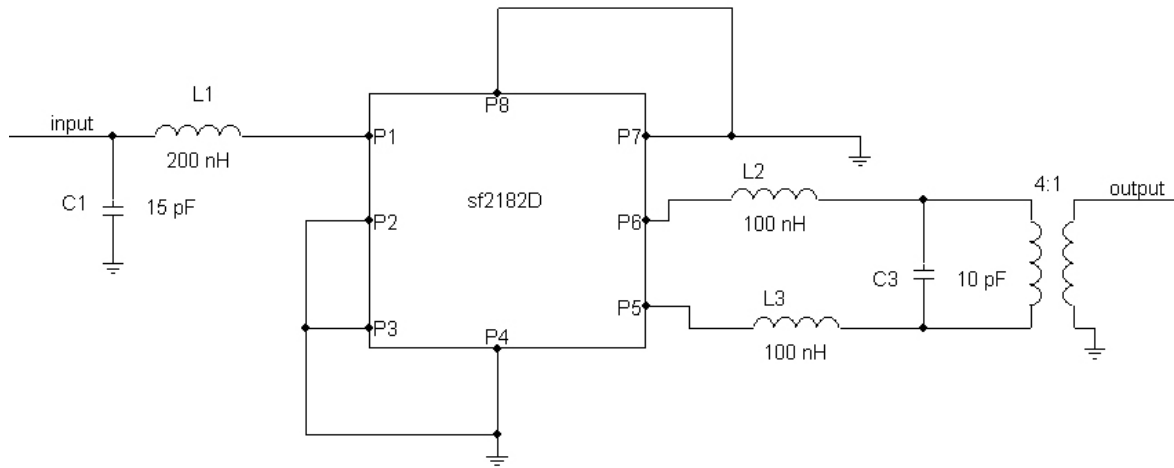

SF2182D, Balanced Input/Output Matching

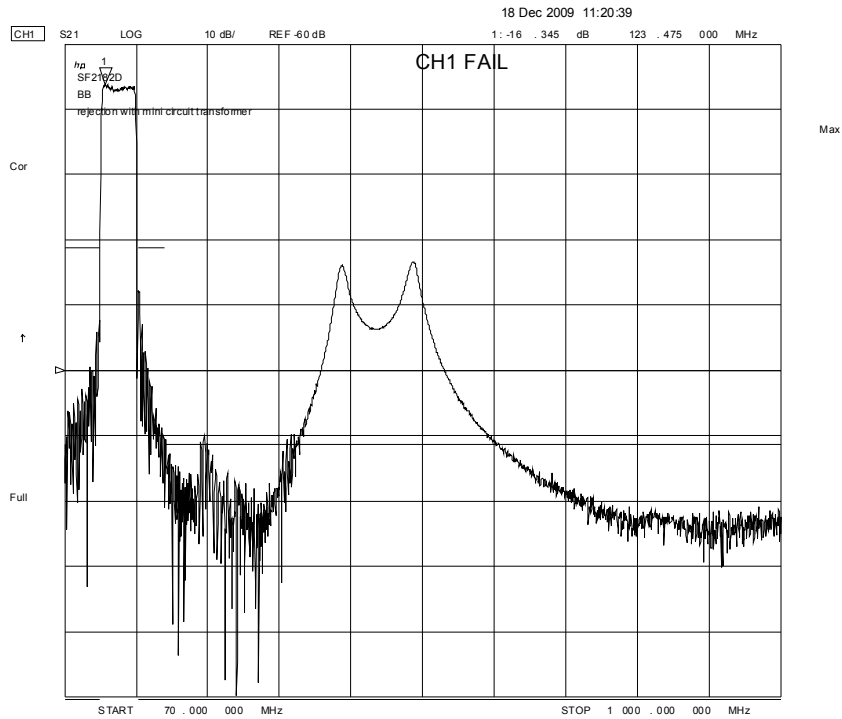
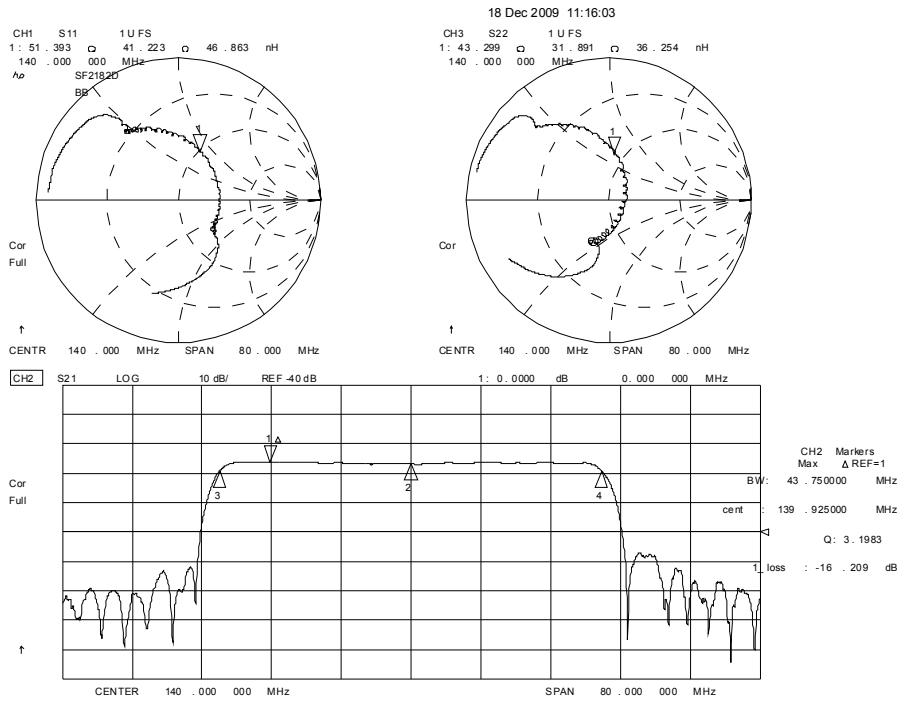

18 Dec 2009 11:17:07

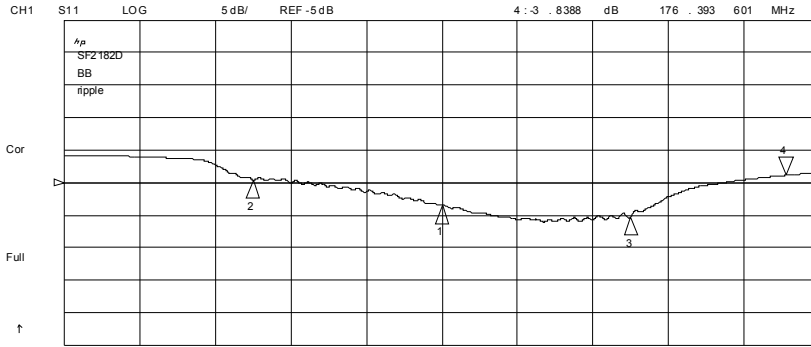

CH1 Markers

1	-8.4796	dB
140	.000	MHz
2	-4.5697	dB
120	.000	MHz
3	-10.201	dB
160	.000	MHz

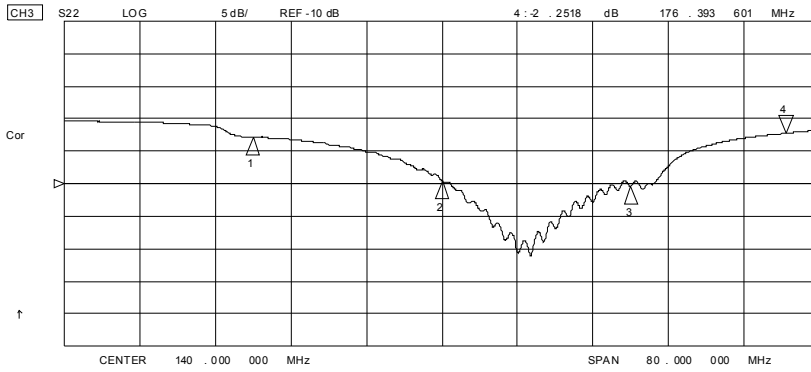

CH3 Markers

1	-2.8494	dB
120	.000	MHz
2	-9.6174	dB
140	.000	MHz
3	-10.349	dB
160	.000	MHz

18 Dec 2009 11:19:05

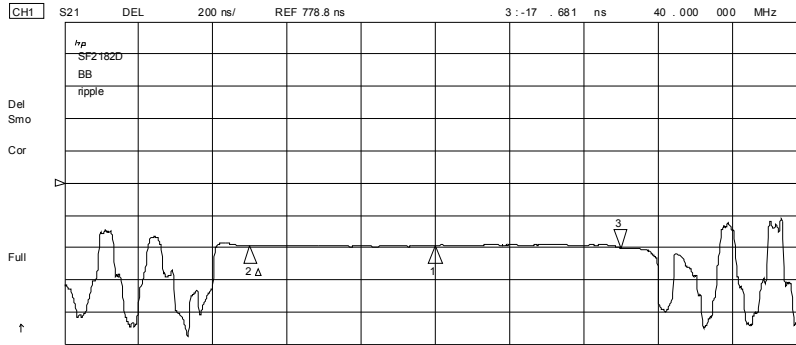

CH1 Markers

mean	: 392.85	ns
s. dev	: 3.5980	ns
p-p	: 23.270	ns

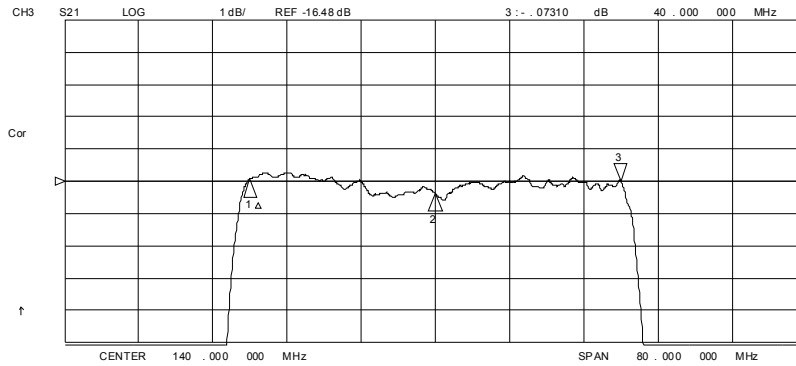

CH3 Markers

mean	: -16.584	dB
s. dev	: .19950	dB
p-p	: .86590	dB

SM3838-8 Case

8-Terminal Ceramic Surface-Mount Case

3.8 X 3.8 mm Nominal Footprint

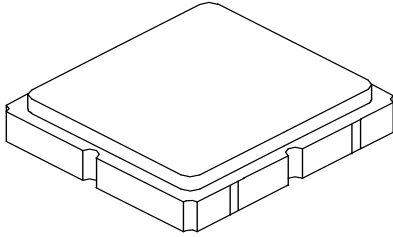

Top View

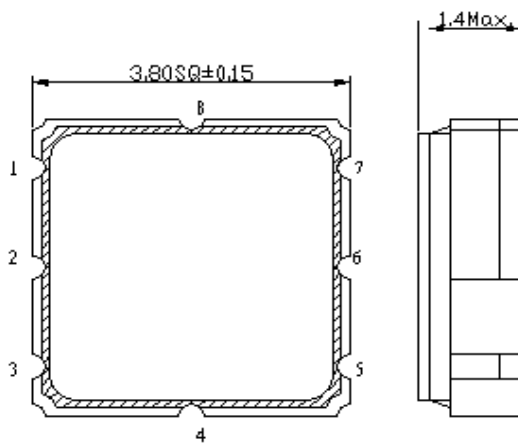

Bottom View

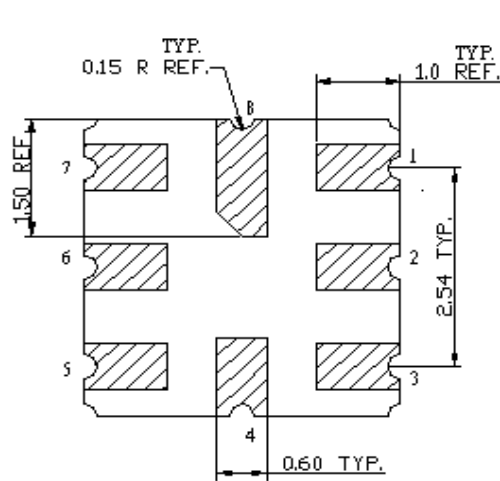

PCB Footprint for 180 Degree Rotation Option

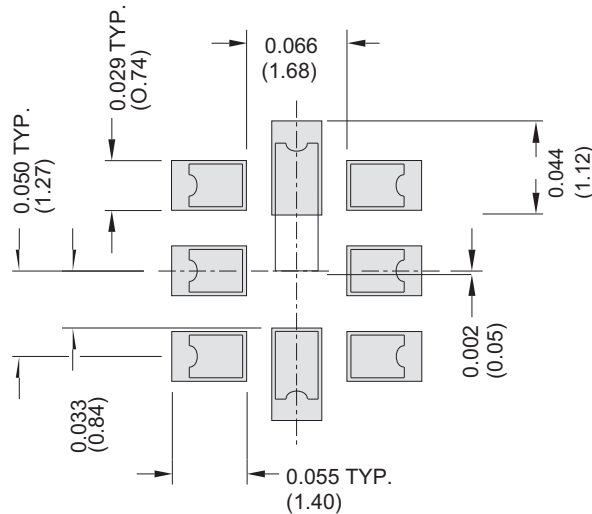

Tape and Reel Specifications

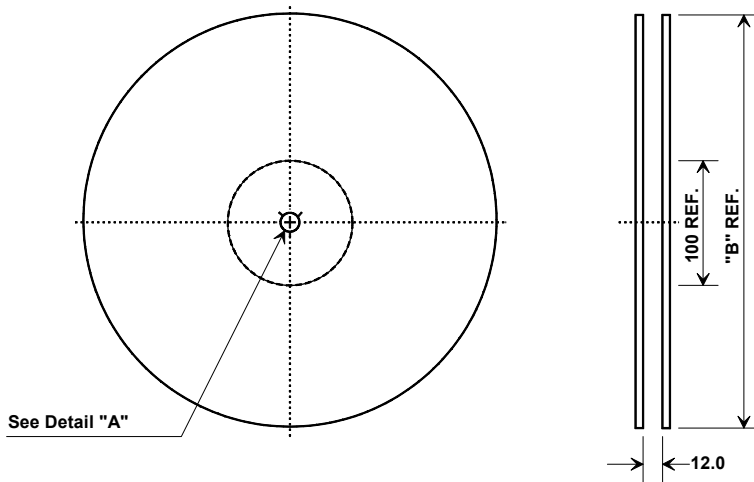

"B"		Quantity Per Reel
Nominal Size		
Inches	millimeters	
7	178	500
13	330	1000

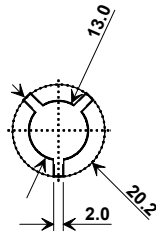

COMPONENT ORIENTATION and DIMENSIONS

Carrier Tape Dimensions	
Ao	4.25 mm
Bo	4.25 mm
Ko	1.30 mm
Pitch	8.0 mm
W	12.0 mm

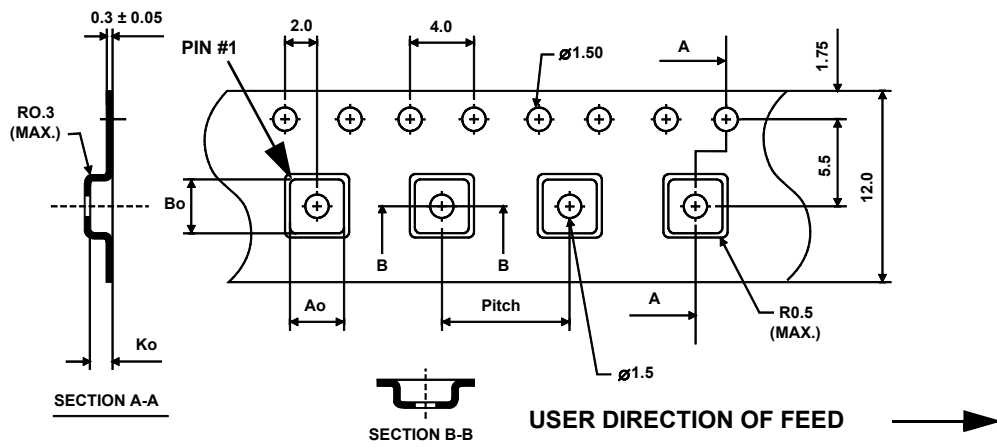

X-ON Electronics

Largest Supplier of Electrical and Electronic Components

Click to view similar products for [Signal Conditioning](#) category:

Click to view products by [Murata](#) manufacturer:

Other Similar products are found below :

[MAPDCC0001](#) [MAPDCC0004](#) [PD0409J5050S2HF](#) [880157](#) [HHS-109-PIN](#) [DC1417J5005AHF](#) [AFS14A30-2185.00-T3](#) [AFS14A35-1591.50-T3](#) [DS-323-PIN](#) [B39321R801H210](#) [1A0220-3](#) [JP510S](#) [LFB212G45SG8C341](#) [LFB322G45SN1A504](#) [LFL182G45TC3B746](#) [SF2159E](#) [30057](#) [FM-104-PIN](#) [CER0813B](#) [MAPDCC0005](#) [3A325](#) [40287](#) [41180](#) [ATB3225-75032NCT](#) [BD0810N50100AHF](#) [C5060J5003AHF](#) [JHS-115-PIN](#) [JP503AS](#) [DC0710J5005AHF](#) [DC2327J5005AHF](#) [DC3338J5005AHF](#) [43020](#) [LFB2H2G60BB1C106](#) [LFL15869MTC1B787](#) [X3C19F1-20S](#) [XC3500P-20S](#) [10013-20](#) [SF2194E](#) [CDBLB455KCAX39-B0](#) [TGL2208-SM, EVAL](#) [RF1353C](#) [1E1305-3](#) [1F1304-3S](#) [1G1304-30](#) [B0922J7575AHF](#) [2020-6622-20](#) [10017-3](#) [TP-103-PIN](#) [BD1222J50200AHF](#) [BD1722J50100AHF](#)