

RECOMMENDED PCB LAYOUT
TOLERANCES UNSPECIFIED ±0.05

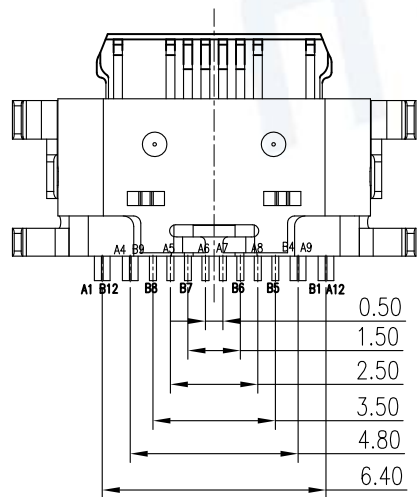

A1	GND	B12	GND
A4	VBUS	B9	VBUS
A5	CC1	B8	SBU2
A6	DP1	B7	DN2
A7	DN1	B6	DP2
A8	SBU1	B5	CC2
A9	VBUS	B4	VBUS
A12	GND	B1	GND
PIN	SIGNAL NAME	PIN	SIGNAL NAME

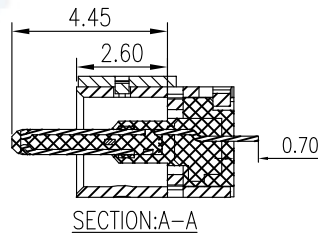
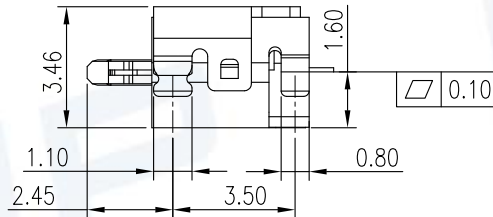
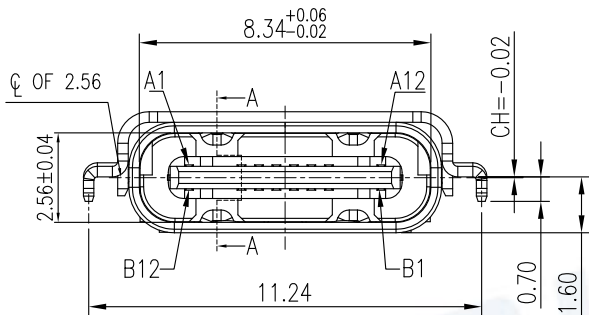

REV.	DESCRIPTION OF REVISIONS	APPR.	CHKD.	DRAW.	DATE
△	Original reversion	lucky	lucky	Roy	2020/09/14
△	Change product model No.	lucky	lucky	Roy	2023/10/25

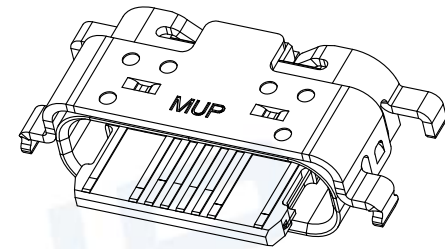

NOTE:

- MECHANICAL:
 - 1-1 Insertion force: 5~20N
 - 1-2 Extraction force: 8~20N
Extraction force: 10000 CYCLES 6~20N
 - 1-3.FREQUENCE:500±50 CYCLES/HOUR,10000 CYCLES;
- ELECTRICAL CHARACTERISTICS:
 - 2-1. CURRENT RATING:
VBUS Pins (A4,A9,B4,B9): 5.0A,
GND/(A1,A12,B1,B12)Vconn(B5) : 1.25A
Other All Pins 0.25A
 - 2-2. INITIAL CONTACT RESISTANCE:40mΩ Max.
 - 2-3. INSULATION RESISTANCE:100MΩ MIN
 - 2-4. WITHSTANDING VOLTAGE:100V AC,1 MINUTE;
- ENVIRONMENTAL
TEMPERATURE RANGE: -40°C TO +85°C.

Model No.	Contact plating	Material
MUP-U22402-01	Au: 3u"	LCP
MUP-U22402-07	Au: 3u"	NYLON
MUP-U22402-08	Au: 15u"	NYLON
MUP-U22402-09	Au: 30u"	NYLON

ITEM	PART NAME	Q'TY	MATERIAL	FINISH
1	Molding	1	THERMOPLASTIC	Black, UL94V-0
2	CONTACT	16	HIGH CONDUCTIVITY COPPER	Contact area:Gold plated over Ni.
3	INNER SHELL	1	STAINLESS STEEL	Ni plated over all
4	OUTER SHELL	1	STAINLESS STEEL	Ni plated over all
5	MID-PLATE	1	STAINLESS STEEL	Cleaning

Unless otherwise specified, other tolerance are:

MUP MUP INDUSTRIAL CO.,LTD.

X ±0.40	X' ±5'	NAME: USB Type C Mid-mount SINGLE-Row SMT Receptacle
X.X ±0.30	X.X' ±4'	MODEL NO: MUP-U22402-XX
X.XX ±0.20	X.XX' ±3'	TYPE: 16Pin & short body double Shell CH=-0.02
X.XXX ±0.10	X.XXX' ±2'	PROJ. UNIT SCALE DRAW
PROJ. UNIT SCALE DRAW	mm 1:1	Roy 2020/09/14
CHECKED	lucky 2020/09/14	DWG NO: DWG-U22402-XX-01
APPROVAL	lucky 2020/09/14	SHEET REVISION
		1/2 2

REV.	DESCRIPTION OF REVISIONS	APPR.	CHKD.	DRAW.	DATE
△	Original reversion	lucky	lucky	Roy	2020/09/14
△	Change product model No.	lucky	lucky	Roy	2023/10/25

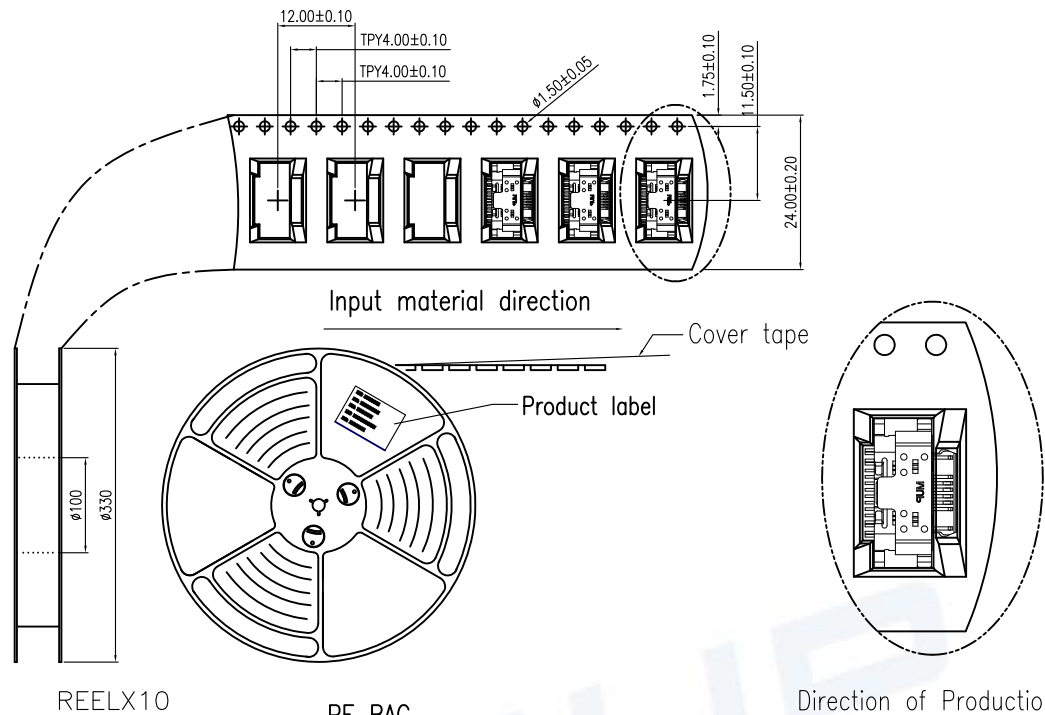

NOTES

1. NUMBER OF CONNECTORS:1500PCS/REEL
2. LEAD TAPE LENGTH

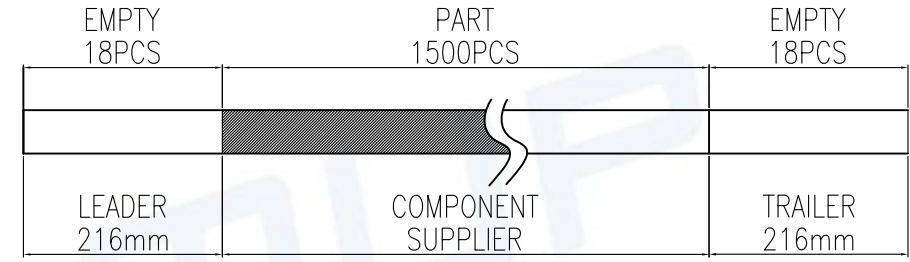

3. QUANTITY:15000/CARTON
4. WEIGHT :
 - 4.1 NET WEIGHT : 6.22 Kg
 - 4.2 GROSS WEIGHT : 10.3 Kg
- 5.Meas:350Lx350Wx315H mm

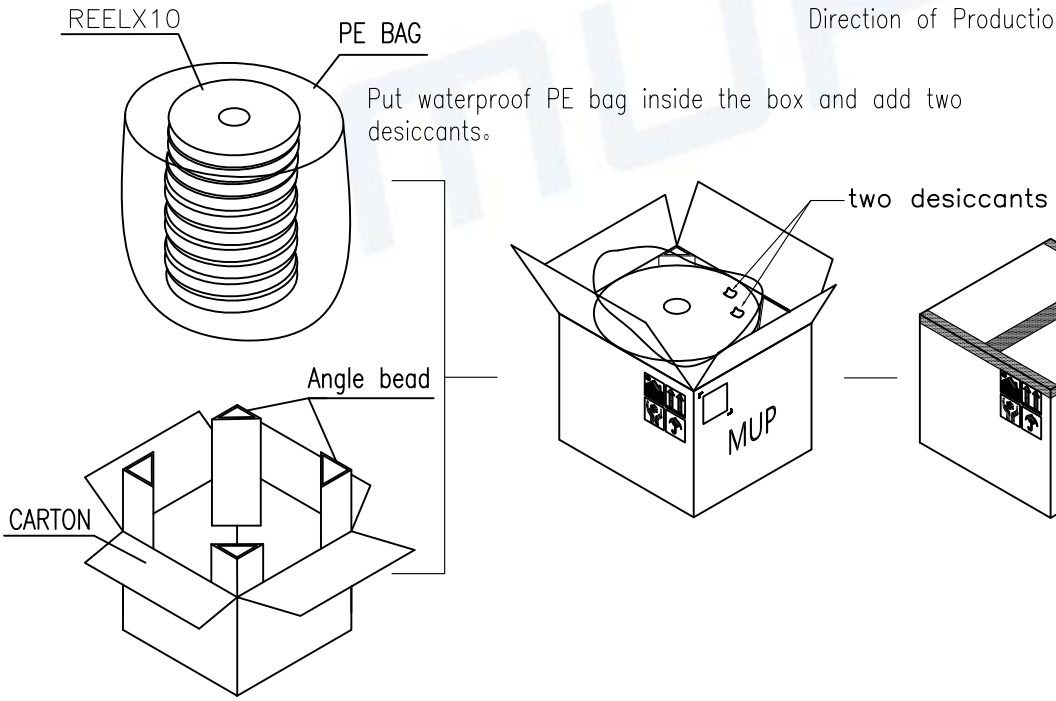

Unless otherwise specified, other tolerance are:		MUP [®] MUP INDUSTRIAL CO.,LTD.			
X ±0.40	X' ±5'	NAME: USB Type C Mid-mount SINGLE-Row SMT Receptacle			
X.X ±0.30	X.X' ±4'	MODEL NO: MUP-U22402-XX			
X.XX ±0.20	X.XX' ±3'	TYPE : 16Pin & short body double Shell CH=-0.02			
X.XXX ±0.10	X.XXX' ±2'	PROJ.	UNIT	SCALE	DRAW
			mm	1:1	Roy 2020/09/14
CUSTOMER DRAWING		APPROVAL	lucky 2020/09/14	DWG NO.:	DWG-U22402-XX-01
				SHEET	2/2
				REVISION	2

X-ON Electronics

Largest Supplier of Electrical and Electronic Components

Click to view similar products for [USB Connectors](#) category:

Click to view products by [Murata](#) manufacturer:

Other Similar products are found below :

[950](#) [MUSBD11135](#) [17-200721](#) [217450-1](#) [KMBVX-TH-5S-B30](#) [KUSBX-AS2N-W](#) [KUSBX-SMT2AP1S-W30](#) [935](#) [957](#) [30-498-6](#) [SK-60A-2](#)
[1734082-1](#) [30-470](#) [30-489](#) [30-541](#) [A-USB A-2P-C](#) [MIKROE-1451](#) [USBFTVSCCG](#) [1-1734084-2](#) [10135326-001LF](#) [4198](#) [USB-A-D-VT](#)
[USB-A-S-RA-TSMT](#) [1310-1023-02](#) [690-024-633-031](#) [UB-20PMFP-LC7001](#) [17-200011](#) [UB-20AFMM-LL7A01](#) [1040870124](#) [CAP-](#)
[WCCMLPB1](#) [CAP-WCCMLPC1](#) [2274475-3](#) [UB-20BMFA-SL8001](#) [914-614A2025S10200](#) [USB3FTV7SAGF059](#) [ZX40-B-5S-1500-](#)
[STDA\(30\)](#) [GSB3116344HR](#) [USB3FTV2SAZNF459](#) [USB3FTV7SAZNF459](#) [U221-041N-1WVS62-F5D](#) [HYCW153-USBD05-500B](#)
[HYCW219-USBD05-075B](#) [HYCW148-USBD05-117B](#) [HYCW149-USBD05-740B](#) [HYCW204-USBD05-108B](#) [HYCW214-USBA04-113B](#)
[HYCW213-USBA04-113B](#) [UB-20AMFM-SL7A01](#) [KMMX-BSMT35S-1-B30TR](#) [2345986-1](#)