

Typical units



FEATURES

- Industry standard DOSA "Sixteenth-brick" format and pinout with surface mount option
- 36-75 Volts DC input range, 3.3, 5 and 12 Vdc outputs.
- 2250 Volt Basic input/output isolation (48V models)
- Up to 100 Watts total output power with overtemperature shutdown
- High efficiency half bridge synchronous rectifier topology
- Stable no-load operation with no required external components
- Operating temperature range -40 to +85°C with derating
- Certified to UL 60950-1, CSA-C22.2 No. 234, EN60950-1 safety approvals, 2nd Edition
- Extensive self-protection shut down features

PRODUCT OVERVIEW

The new ULS 100 Watts series offers output voltages of 3.3Vout (30A), 5Vout (20A) and 12Vout (8.3A). The ULS sixteenth-brick series maintains a width of 0.9 inches while still retaining up to 100 Watt output and full 2250 Volt DC isolation. The PC-board mount converter family accepts 36 to 75 Volts DC inputs and delivers fixed outputs regulated to within $\pm 0.2\%$. The ULS converters are ideal for datacom and telecom applications, cell phone towers, data centers, server farms and network repeaters.

ULS outputs may be trimmed within $\pm 10\%$ of nominal output while delivering fast settling to current step loads and no adverse effects from higher capacitive loads. Excellent ripple and noise specifications assure compatibility to circuits using CPU's, ASIC's, programmable logic and FPGA's. No

minimum load is required. For systems requiring controlled startup/shutdown, an external remote On/Off control may use a switch, transistor or digital logic. Remote Sense inputs compensate for resistive line drops at high currents.

Many self-protection features on the ULS series avoid both converter and external circuit hazards. These include input undervoltage lockout and overtemperature shutdown. The outputs current limit using the "hiccup" autorestart technique and the outputs may be short-circuited indefinitely. Additional features include output overvoltage and reverse conduction elimination.

The half bridge synchronous rectifier topology yields high efficiency for minimal heat buildup and "no fan" operation.

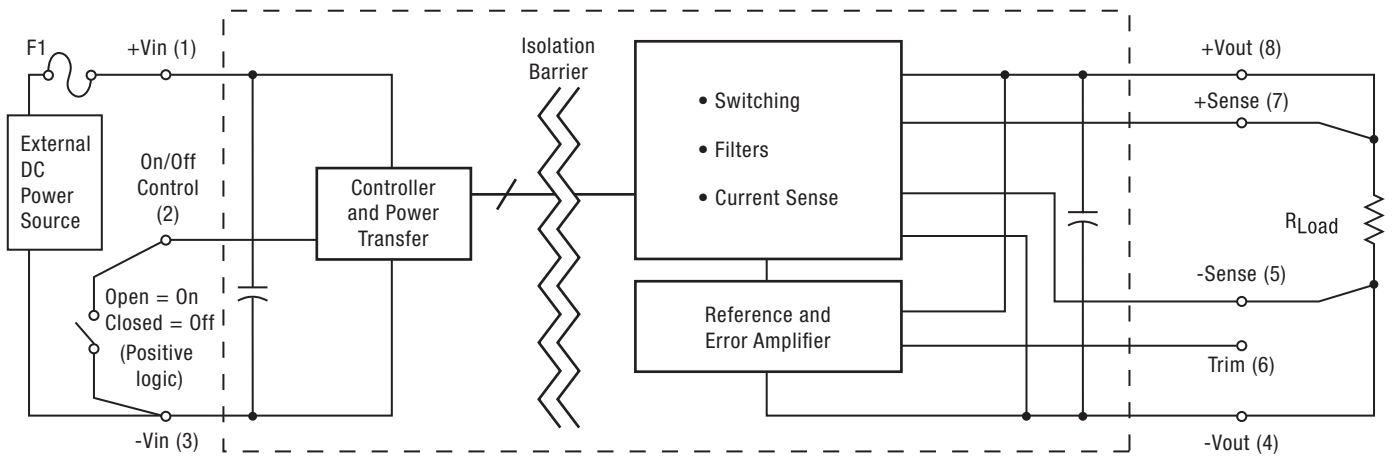

Typical topology is shown

Figure 1. Simplified Block Diagram



PERFORMANCE SPECIFICATIONS SUMMARY AND ORDERING GUIDE ^①														
Root Model ^①	Output						Input				Efficiency		Dimensions (inches)	
	V _{OUT} (V)	I _{OUT} (A, max.)	Power (W)	R/N (mV pk-pk) ^②		Regulation (max.) ^③		V _{IN} Nom. (V)	Range (V)	I _{IN} , no load (mA)	I _{IN} , full load (A)	Min.		Typ.
				Typ.	Max.	Line	Load							
ULS-3.3/30-D48	3.3	30	99	70	100	±0.1%	±0.2%	48	36-75	50	2.27	90%	91%	1.3x0.9x0.4
ULS-5/20-D48	5	20	100	60	120	±0.125%	±0.125%	48	36-75	50	2.29	89%	91%	1.3x0.9x0.4
ULS-12/8.3-D48	12	8.3	99.6	80	150	±0.125%	±0.25%	48	36-75	50	2.26	89%	92%	1.3x0.9x0.4

- ① Please refer to the Part Number Structure when ordering.
- ② All specifications are typical at nominal line voltage and full load, +25°C unless otherwise noted. See detailed specifications. Output capacitors are 1 µF ceramic multilayer in parallel with 10 µF and a 220µF/100V external input capacitor is needed for the ULS-12/8.3-D48 model. I/O caps are necessary for our test equipment and may not be needed for your application.
- ③ Regulation specifications describe output voltage deviations from a nominal/midpoint value to either extreme (50% load step).

PART NUMBER STRUCTURE

ULS - 3.3 / 30 - D48 N M H Lx - C

- Sixteenth Brick Series**
- Nominal Output Voltage:** 3.3V
- Maximum Rated Output Current**
Current in Amps: 30A
- Input Voltage Range:** D48 = 36-75 Volts (48V nominal)
- RoHS Hazardous Substance Compliance**
(does not claim EU RoHS exemption 7b-lead in solder)
C = RoHS-6
- Pin Length Option (Thru-hole only)**
Blank = Standard pin length 0.180" (4.6mm)
L1 = 0.110" (2.79mm)*
L2 = 0.145" (3.68mm)*
- Conformal Coating Option**
Blank = No coating, standard
H = Coating added, optional*
(H option is not available on SMT models.)
- SMT Version Option**
Blank = Through-hole mount, no SMT
M = Surface mount (MSL Rating 2a, Reflow temp ≤ 250°C)
- On/Off Control Logic Option**
N = Negative
P = Positive

*Special quantity order is required; no sample quantities available.

Note: Some model number combinations may not be available. Contact Murata Power Solutions.

FUNCTIONAL SPECIFICATIONS, ULS-3.3/30-D48

ABSOLUTE MAXIMUM RATINGS	Conditions ①	Minimum	Typical/Nominal	Maximum	Units
Input Voltage, Continuous		0		80	Vdc
Input Voltage, Transient	100 mS max. duration			100	Vdc
Isolation Voltage	Input to output, continuous			2250	Vdc
Input Reverse Polarity	None, install external fuse		None		Vdc
On/Off Remote Control	Power on, referred to -Vin	0		15	Vdc
Output Power		0		99.99	W
Output Current	Current-limited, no damage, short-circuit protected	0		30	A
Storage Temperature Range	Vin = Zero (no power)	-55		125	°C
Absolute maximums are stress ratings. Exposure of devices to greater than any of these conditions may adversely affect long-term reliability. Proper operation under conditions other than those listed in the Performance/Functional Specifications Table is not implied or recommended.					
INPUT					
Operating voltage range		36	48	75	Vdc
Recommended External Fuse	Fast blow			10	A
Start-up threshold	Rising input voltage	32.5	34.5	35.5	Vdc
Undervoltage shutdown	Falling input voltage	31	33	34	Vdc
Overvoltage shutdown			None		Vdc
Reverse Polarity Protection	None, install external fuse		None		Vdc
Internal Filter Type			C		
Input current					
Full Load Conditions	Vin = nominal		2.27	2.31	A
Low Line	Vin = minimum		3.06	3.12	A
Inrush Transient			0.05		A ² -Sec.
Short Circuit Input Current			50	100	mA
No Load	Iout = minimum, unit = ON		50	150	mA
Shut-Down Input Current (Off)			14	18	mA
Reflected (back) ripple current ②	Measured at input with specified filter		20	30	mA, p-p
GENERAL and SAFETY					
Efficiency	Vin = 48V, full load	90	91		%
	Vin = max., full load	89	90		%
Isolation					
Isolation Voltage	Input to output, continuous		2250		Vdc
Insulation Safety Rating			basic		
Isolation Resistance			100		MΩ
Isolation Capacitance			3300		pF
Safety	Certified to UL-60950-1, CSA-C22.2 No. 60950-1, IEC/EN60950-1, 2nd edition		Yes		
Calculated MTBF	Per Telcordia SR332, issue 1, class 3, ground fixed, Tambient = +25°C		2.6		Hours x 10 ⁶
DYNAMIC CHARACTERISTICS					
Fixed Switching Frequency		460	480	500	KHz
Startup Time	Power on to Vout regulated		5	20	mS
Startup Time	Remote ON to Vout regulated		5	20	mS
Dynamic Load Response	50-75-50% load step, settling time to within 2% of Vout		10	25	μSec
Dynamic Load Peak Deviation	same as above		±75	±150	mV
FEATURES and OPTIONS					
Remote On/Off Control					
"N" suffix:					
Negative Logic, ON state	ON = Ground pin or external voltage	-0.1		0.8	V
Negative Logic, OFF state	OFF = Pin open or external voltage	2.5		15	V
Control Current	Open collector/drain		1	2	mA
"P" suffix:					
Positive Logic, ON state	ON = Pin open or external voltage	3.5		15	V
Positive Logic, OFF state	OFF = Ground pin or external voltage	0		1	V
Control Current	Open collector/drain		1	2	mA
SMT Mounting	"M" suffix				
Remote Sense	Sense pins connected externally to respective Vout pins			10	%

FUNCTIONAL SPECIFICATIONS, ULS-3.3/30-D48 (CONT.)

OUTPUT	Conditions ①	Minimum	Typical/Nominal	Maximum	Units
Total Output Power	See Derating	98.1	99	99.99	W
Voltage					
Nominal Output Voltage	No trim	3.267	3.3	3.333	Vdc
Setting Accuracy	At 50% load, no trim	-1		1	% of Vnom
Output Voltage Range	User-adjustable	-10		10	% of Vnom.
Overvoltage Protection	Via magnetic feedback	3.9	4.25	4.95	Vdc
Current					
Output Current Range		0	30	30	A
Minimum Load					
Current Limit Inception	98% of Vnom., after warmup	33	37	44	A
Short Circuit					
Short Circuit Current	Hiccup technique, autorecovery within ±1.25% of Vout		2	5	mA
Short Circuit Duration (remove short for recovery)	Output shorted to ground, no damage		Continuous		
Short circuit protection method	Current limiting				
Regulation					
Line Regulation	Vin = min. to max., Vout = nom., Iout = nom.			±0.1	% of Vout
Load Regulation	Iout = min. to max., Vin = 48V			±0.2	% of Vout
Ripple and Noise	5 Hz- 20 MHz BW		70	100	mV pk-pk
Temperature Coefficient	At all outputs		±0.02		% of Vout./°C
Maximum Capacitive Loading	Low ESR, resistive load only			4700	µF
MECHANICAL (Through Hole Models)					
Outline Dimensions			1.3X0.9X0.4		Inches
(Please refer to outline drawing)	LxWxH		33X22.9X10.2		mm
Weight			0.56		Ounces
			16		Grams
Through Hole Pin Diameter			0.04 & 0.06		Inches
			1.016X1.524		mm
Through Hole Pin Material			Copper alloy		
TH Pin Plating Metal and Thickness	Nickel subplate		50		µ-inches
	Gold overplate		5		µ-inches
ENVIRONMENTAL					
Operating Ambient Temperature Range	With Derating	-40		85	°C
Operating Case Temperature Range	No derating	-40		120	°C
Storage Temperature	Vin = Zero (no power)	-55		125	°C
Thermal Protection/Shutdown	Measured in center	115	125	130	°C
Electromagnetic Interference	External filter is required				
Conducted, EN55022/CISPR22			B		Class
Radiated, EN55022/CISPR22			B		Class
Relative humidity, non-condensing	To +85°C	10		90	%RH
Altitude	must derate -1%/1000 feet	-500		10,000	feet
		-152		3048	meters
RoHS rating			RoHS-6		

Functional Specification Notes

- ① All specifications are typical unless noted. Ambient temperature = +25°Celsius, V_{IN} is nominal, output current is maximum rated nominal. External output capacitance is 1 μ F multilayer ceramic paralleled with 10 μ F electrolytic. All caps are low ESR. These capacitors are necessary for our test equipment and may not be needed in your application. Testing must be kept short enough that the converter does not appreciably heat up during testing. For extended testing, use plenty of airflow. See Derating Curves for temperature performance. All models are stable and regulate within spec without external capacitance.
- ② Input Ripple Current is tested and specified over a 5-20 MHz bandwidth and uses a special set of external filters only for the Ripple Current specifications. Input filtering is $C_{IN} = 33 \mu\text{F}$, $C_{BUS} = 220 \mu\text{F}$, $L_{BUS} = 12 \mu\text{H}$. Use capacitor rated voltages which are twice the maximum expected voltage. Capacitors must accept high speed AC switching currents.
- ③ Note that Maximum Current Derating Curves indicate an average current at nominal input voltage. At higher temperatures and/or lower airflow, the converter will tolerate brief full current outputs if the average RMS current over time does not exceed the Derating curve. All Derating curves are presented at sea level altitude. Be aware of reduced power dissipation with increasing density altitude.
- ④ Mean Time Before Failure (MTBF) is calculated using the Telcordia (Belcore) SR-332 Method 1, Case 3, Issue 1, ground fixed conditions. Operating temperature = +25°C, full output load, natural air convection.
- ⑤ The output may be shorted to ground indefinitely with no damage. The Output Short Circuit Current shown in the specifications is an average consisting of very short bursts of full rated current to test whether the output circuit can be repowered.
- ⑥ The On/Off Control is normally driven from a switch or relay. An open collector/open drain transistor may be used in saturation and cut-off (pinch-off) modes. External logic may also be used if voltage levels are fully compliant to the specifications.
- ⑦ Regulation specifications describe the deviation as the input line voltage or output load current is varied from a nominal midpoint value to either extreme (50% load).
- ⑧ Do not exceed maximum power ratings, Sense limits or output overvoltage when adjusting output trim values.
- ⑨ At zero output current, V_{out} may contain components which slightly exceed the ripple and noise specifications.
- ⑩ Output overload protection is non-latching. When the output overload is removed, the output will automatically recover.
- ⑪ All models are fully operational and meet published specifications, including “cold start” at -40°C .
- ⑫ The converter will shut off if the input falls below the undervoltage threshold. It will not restart until the input exceeds the Input Start Up Voltage.
- ⑬ Short circuit shutdown begins when the output voltage degrades approximately 2% from the selected setting.
- ⑭ Output noise may be further reduced by installing an external filter. See the Application Notes. Use only as much output filtering as needed ***and no more***. Larger caps (especially low-ESR ceramic types) may slow transient response or degrade dynamic performance. Thoroughly test your application with all components installed.
- ⑮ To avoid damage or unplanned shutdown, do not sink appreciable reverse output current.
- ⑯ A fast blow fuse must be installed in series with $+V_{in}$ to avoid damage to the converter in the event that the source voltage is accidentally applied to the converter with reverse polarity.
- ⑰ Although extremely unlikely, failure of the internal components of this product may expose external application circuits to dangerous voltages, currents, temperatures or power levels. Please thoroughly verify all applications before committing them to service. Be sure to include appropriately rated FUSES (see specifications and Application Notes) to reduce the risk of failure.
- ⑱ If Sense is not wired to an external load, connect sense pins to their respective V_{out} pins. Do not leave sense unconnected.
- ⑲ The switching frequencies of these converters are fixed; see individual specifications for model details.

TYPICAL PERFORMANCE DATA, ULS-3.3/30-D48

Efficiency and Power Dissipation

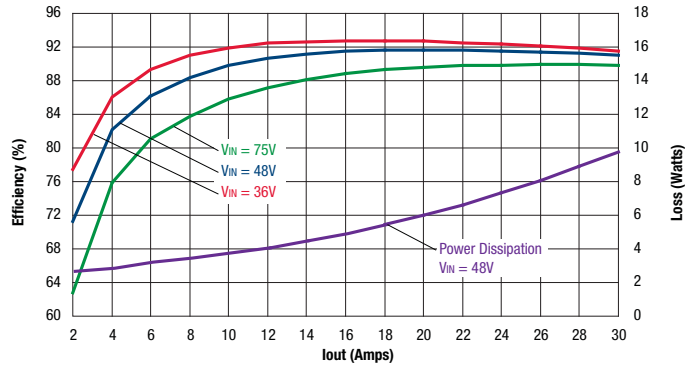

Maximum Current Temperature Derating at Sea Level
(V_{IN} = 48V, airflow is from Vin- to Vin+)

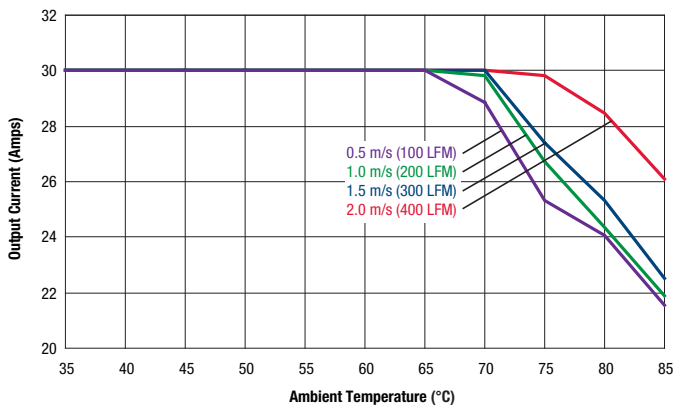

Maximum Current Temperature Derating at Sea Level
(V_{IN} = 48V, airflow is from Vin to Vout)

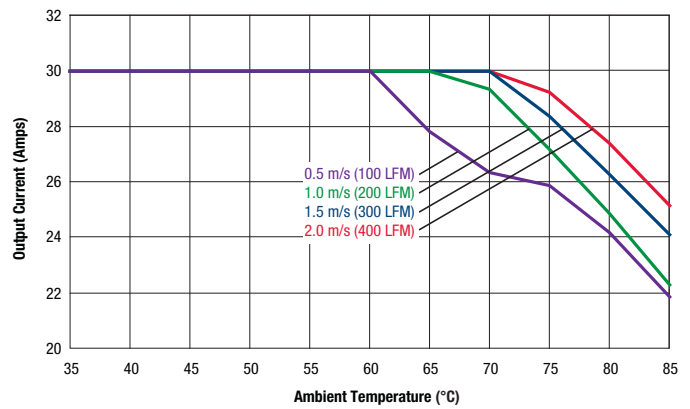

Output Ripple and Noise (V_{in}=48V, I_{out}=0A, T_a=+25°C, V_{out}-ripple=43.3mV)

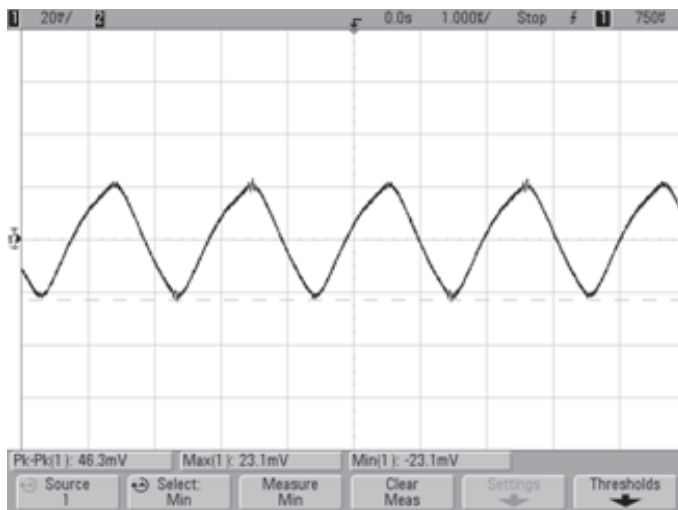

Output Ripple and Noise (V_{in}=48V, I_{out}=30A, T_a=+25°C, V_{out}-ripple=45.6mV)

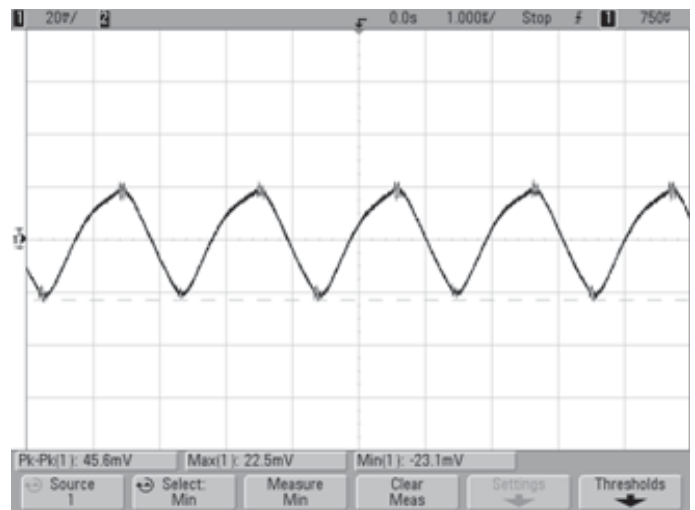

TYPICAL PERFORMANCE DATA, ULS-3.3/30-D48

Enable startup Delay (Vin=48V, Vout=nom, Iout=30A, Cload=4700uF, Ta=+25°C) Trace2=Vout, Trace4=Enable

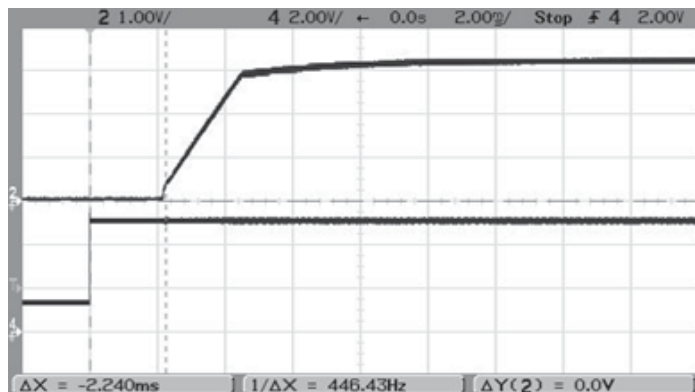

Startup Delay (Vin=48V, Vout=nom, Iout=30A, Cload=4700uF, Ta=+25°C) Trace1=Vin, Trace2=Vout

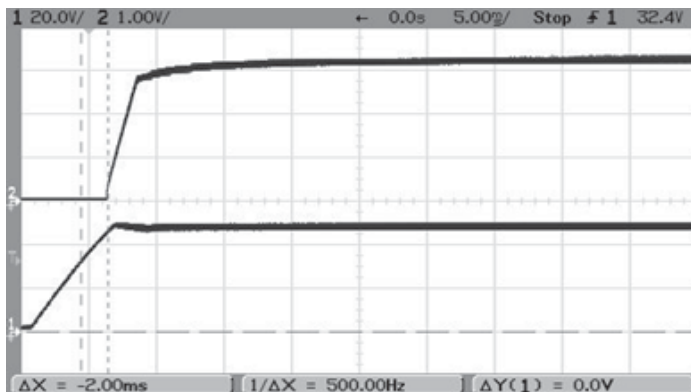

Step Load Transient Response (Vin=48V, Vout=nom, Iout=75% to 50% of full load, 1A/uS at Ta=+25°C) +Delta=61mV, Recovery time=8.4uS

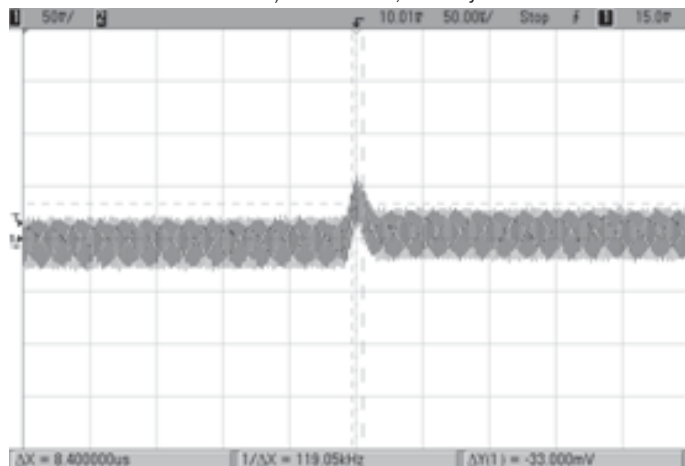

Step Load Transient Response (Vin=48V, Vout=nom, Iout=50% to 75% of full load, 1A/uS at Ta=+25°C) +Delta=64mV, Recovery time=7.6uS

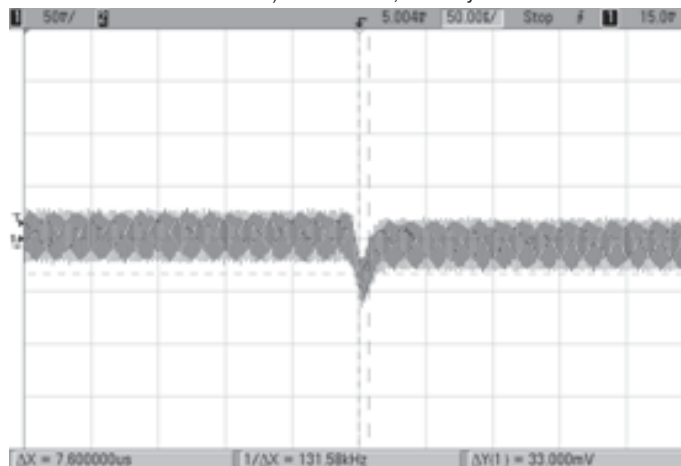

Step Load Transient Response (Vin=48V, Vout=nom, Iout=50% to 75% of full load, 1A/uS at Ta=+25°C)

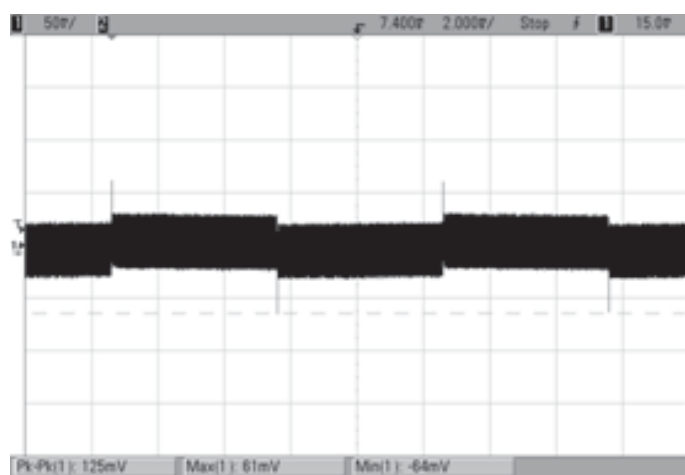

Thermal image with hot spot at full load (30A) current with 30°C ambient; air is flowing at 100 LFM. Air is flowing across the converter from Vin to Vout at 48V input. Identifiable and recommended maximum value to be verified in application. Hottest spot is Q4=88.9°C.

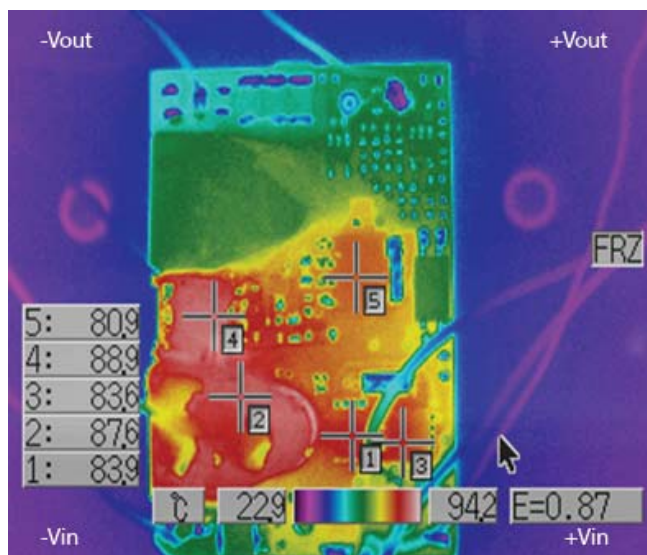

Emissions Performance, Model ULS-3.3/30-D48

Murata Power Solutions measures its products for radio frequency emissions against the EN 55022 and CISPR 22 standards. Passive resistance loads are employed and the output is set to the maximum voltage. If you set up your own emissions testing, make sure the output load is rated at continuous power while doing the tests.

The recommended external input and output capacitors (if required) are included. Please refer to the fundamental switching frequency. All of this information is listed in the Product Specifications. An external discrete filter is installed and the circuit diagram is shown below.

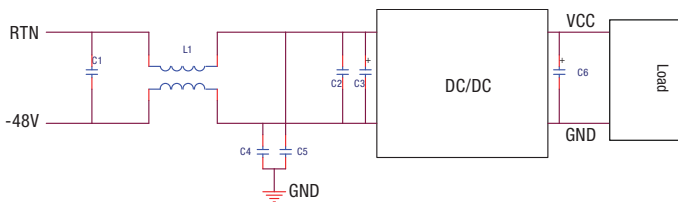

Figure 2. Conducted Emissions Test Circuit

[1] Conducted Emissions Parts List

[2] Conducted Emissions Test Equipment Used

Hewlett Packard HP8594L Spectrum Analyzer –S/N 3827A00153

2Line V-networks LS1-15V 50Ω/50uH Line Impedance Stabilization Network

[3] Conducted Emissions Test Results

Reference	Part Number	Description	Vendor
C1	GRM32ER-72A105KA01L	SMD CERAMIC-100V-1000nF-X7R-1210	Murata
C2	GRM-319R72A104KA01D	SMD CERAMIC 100V-100nF-±10%-X7R-1206	Murata
L1	LB16H1324	COMMON MODE-1320uH-±25%-4A-R5K-21*21*12.5mm	High Light
C4, C5	GRM-32DR73A223KW01L	SMD CERAMIC 1000V-0.022uF-±10%-X7R-1210	Murata
C3	UHE2A221MHD	Aluminum 100V-320uF-±10%-long lead	Nichicon
C6	NA		

[4] Layout Recommendations

Most applications can use the filtering which is already installed inside the converter or with the addition of the recommended external capacitors. For greater emissions suppression, consider additional filter components and/or shielding. Emissions performance will depend on the user's PC board layout, the chassis shielding environment and choice of external components. Please refer to Application Note GEANO2 for further discussion.

Since many factors affect both the amplitude and spectra of emissions, we recommend using an engineer who is experienced at emissions suppression.

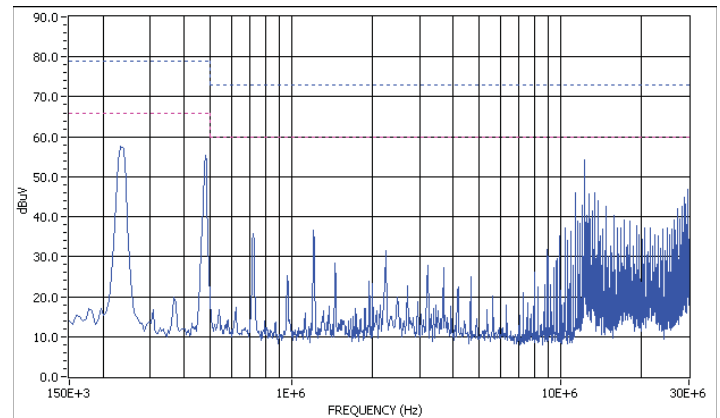

Peak Detection Value

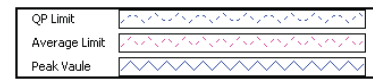

Graph 1. Conducted emissions performance, Positive Line, CISPR 22, Class A, 48Vin, full load

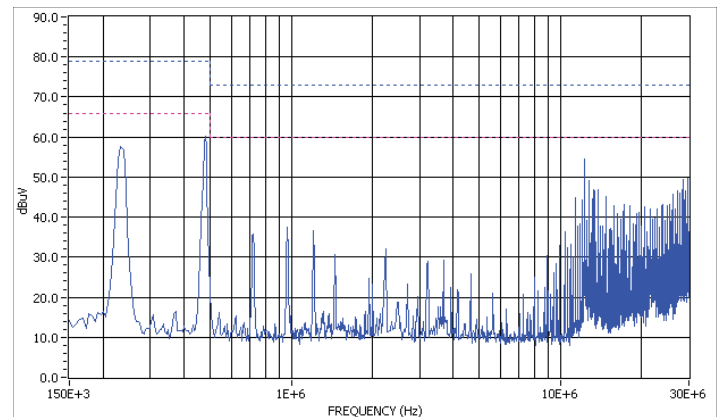

Peak Detection Value

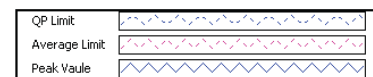

Graph 2. Conducted emissions performance, Negative Line, CISPR 22, Class A, 48Vin, full load

Contact Murata Power Solutions for Class B Emissions test circuit and conducted emissions performance test results.

FUNCTIONAL SPECIFICATIONS, ULS-5/20-D48

ABSOLUTE MAXIMUM RATINGS	Conditions ①	Minimum	Typical/Nominal	Maximum	Units
Input Voltage, Continuous		0		80	Vdc
Input Voltage, Transient	100 mS max. duration			100	Vdc
Isolation Voltage	Input to output, continuous			2250	Vdc
Input Reverse Polarity	None, install external fuse		None		Vdc
On/Off Remote Control	Power on, referred to -Vin	0		15	Vdc
Output Power		0		101	W
Output Current	Current-limited, no damage, short-circuit protected	0		20	A
Storage Temperature Range	Vin = Zero (no power)	-55		125	°C
Absolute maximums are stress ratings. Exposure of devices to greater than any of these conditions may adversely affect long-term reliability. Proper operation under conditions other than those listed in the Performance/Functional Specifications Table is not implied or recommended.					
INPUT					
Operating voltage range		36	48	75	Vdc
Recommended External Fuse	Fast blow			10	A
Start-up threshold	Rising input voltage	32.5	34.5	35.5	Vdc
Undervoltage shutdown	Falling input voltage	31	32.5	34	Vdc
Overvoltage shutdown			None		Vdc
Reverse Polarity Protection	None, install external fuse		None		Vdc
Internal Filter Type			C		
Input current					
Full Load Conditions	Vin = nominal		2.29	2.36	A
Low Line	Vin = minimum		3.05	3.15	A
Inrush Transient			0.05		A ² -Sec.
Short Circuit Input Current			50	100	mA
No Load	Iout = minimum, unit = ON		50	100	mA
Shut-Down Input Current (Off)			15	18	mA
Reflected (back) ripple current ②	Measured at input with specified filter		15	30	mA, p-p
GENERAL and SAFETY					
Efficiency	Vin = 48V, full load	89	91		%
	Vin = min., full load	89	91		%
Isolation					
Isolation Voltage	Input to output, continuous		2250		Vdc
Insulation Safety Rating			basic		
Isolation Resistance			100		MΩ
Isolation Capacitance			3300		pF
Safety	Certified to UL-60950-1, CSA-C22.2 No. 60950-1, IEC/EN60950-1, 2nd edition		Yes		
Calculated MTBF	Per Telcordia SR332, issue 1, class 3, ground fixed, Tambient = +25°C		2.6		Hours x 10 ⁶
DYNAMIC CHARACTERISTICS					
Fixed Switching Frequency		470	520	570	KHz
Startup Time	Power on to Vout regulated			15	mS
Startup Time	Remote ON to Vout regulated			20	mS
Dynamic Load Response	50-75-50% load step, settling time to within 1% of Vout		10	100	μSec
Dynamic Load Peak Deviation	same as above		±180	±240	mV
FEATURES and OPTIONS					
Remote On/Off Control					
"N" suffix:					
Negative Logic, ON state	ON = Ground pin or external voltage	-0.1		0.8	V
Negative Logic, OFF state	OFF = Pin open or external voltage	2.5		15	V
Control Current	Open collector/drain		1	2	mA
"P" suffix:					
Positive Logic, ON state	ON = Pin open or external voltage	3.5		15	V
Positive Logic, OFF state	OFF = Ground pin or external voltage	0		1	V
Control Current	Open collector/drain		1	2	mA
SMT Mounting	"M" suffix				
Remote Sense	Sense pins connected externally to respective Vout pins			10	%

FUNCTIONAL SPECIFICATIONS, ULS-5/20-D48 (CONT.)

OUTPUT	Conditions ①	Minimum	Typical/Nominal	Maximum	Units
Total Output Power	See Derating	99	100	101	W
Voltage					
Nominal Output Voltage	No trim	4.95	5	505	Vdc
Setting Accuracy	At 50% load, no trim	-1		1	% of Vnom
Output Voltage Range	User-adjustable	-10		10	% of Vnom.
Overvoltage Protection	Via magnetic feedback	5.6	6.3	9	Vdc
Current					
Output Current Range		0	20	20	A
Minimum Load					
Current Limit Inception	98% of Vnom., after warmup	22	24	32	A
Short Circuit					
Short Circuit Current	Hiccup technique, autorecovery within ±1.25% of Vout		.6		A
Short Circuit Duration (remove short for recovery)	Output shorted to ground, no damage		Continuous		
Short circuit protection method	Current limiting				
Regulation					
Line Regulation	Vin = min. to max., Vout = nom., Iout = nom.			±0.125	% of Vout
Load Regulation	Iout = min. to max., Vin = 48V			±0.125	% of Vout
Ripple and Noise	5 Hz- 20 MHz BW		60	120	mV pk-pk
Temperature Coefficient	At all outputs		±0.02		% of Vout./°C
Maximum Capacitive Loading	Low ESR, resistive load only	330		3300	µF
MECHANICAL (Through Hole Models)					
Outline Dimensions			1.3X0.9X0.4		Inches
(Please refer to outline drawing)	LxWxH		33X22.9X10.2		mm
Weight			0.58		Ounces
			16.5		Grams
Through Hole Pin Diameter			0.04 & 0.06		Inches
			1.016X1.524		mm
Through Hole Pin Material			Copper alloy		
TH Pin Plating Metal and Thickness	Nickel subplate		50		µ-inches
	Gold overplate		5		µ-inches
ENVIRONMENTAL					
Operating Ambient Temperature Range	With Derating	-40		85	°C
Operating Case Temperature Range	No derating	-40		120	°C
Storage Temperature	Vin = Zero (no power)	-55		125	°C
Thermal Protection/Shutdown	Measured in center	115	125	130	°C
Electromagnetic Interference	External filter is required				
Conducted, EN55022/CISPR22			B		Class
Radiated, EN55022/CISPR22			B		Class
RoHS rating			RoHS-6		

TYPICAL PERFORMANCE DATA, ULS-5/20-D48

Efficiency and Power Dissipation

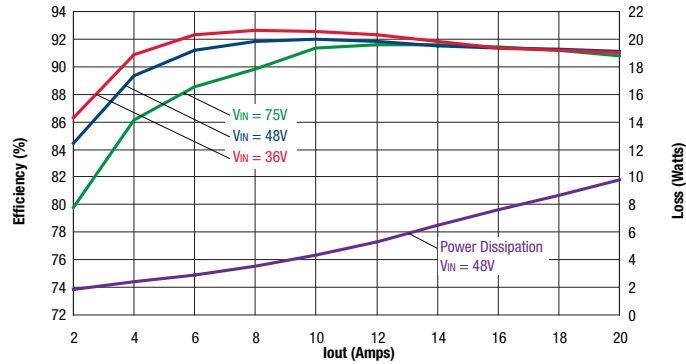

Maximum Current Temperature Derating at Sea Level
($V_{IN} = 48V$, airflow is from Vin- to Vin+)

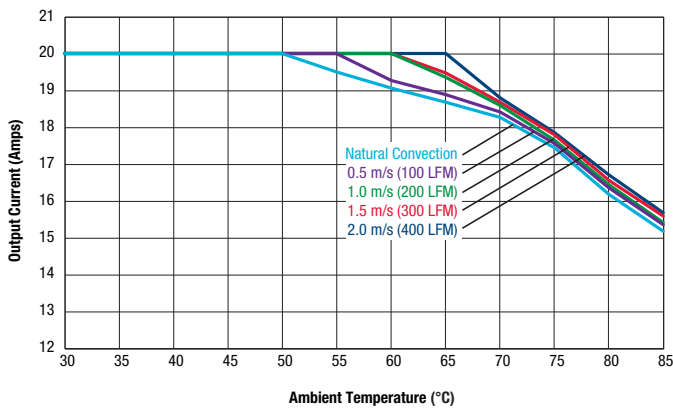

Maximum Current Temperature Derating at Sea Level
($V_{IN} = 48V$, airflow is from Vin to Vout)

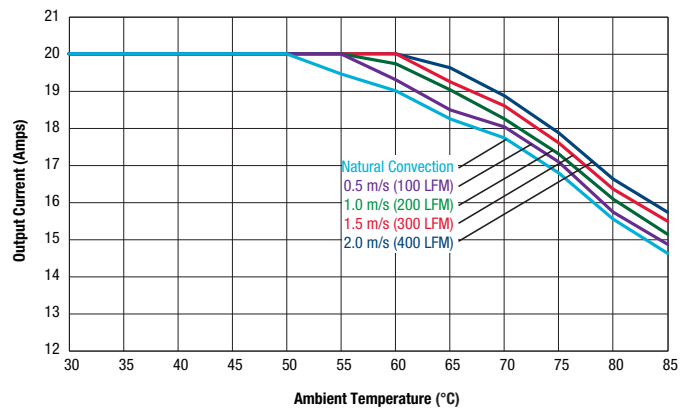

Output Ripple and noise ($V_{IN} = 48V$, $V_{out} = \text{nom}$, $I_{out} = 20A$, $C_{load} = 330\mu F$, $T_a = +25^\circ C$)

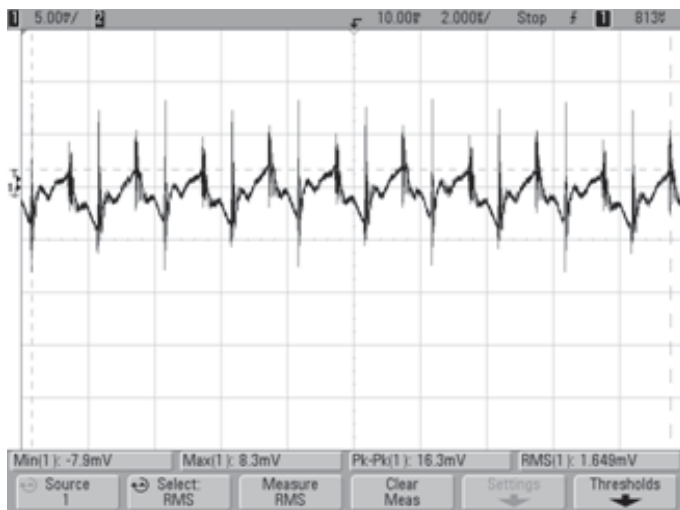

Output Ripple and noise ($V_{IN} = 48V$, $V_{out} = \text{nom}$, $I_{out} = 0A$, $C_{load} = 330\mu F$, $T_a = +25^\circ C$)

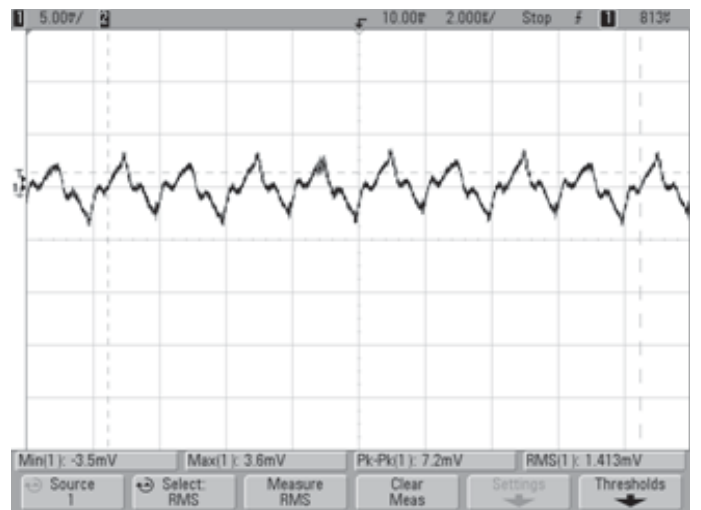

TYPICAL PERFORMANCE DATA, ULS-5/20-D48

Enable Startup Delay (Vin = 48V, Vout = nom, Iout = 20A, Cload = 330uF, Ta = +25°C)
Ch2 = Vout, Ch4 = Enable.

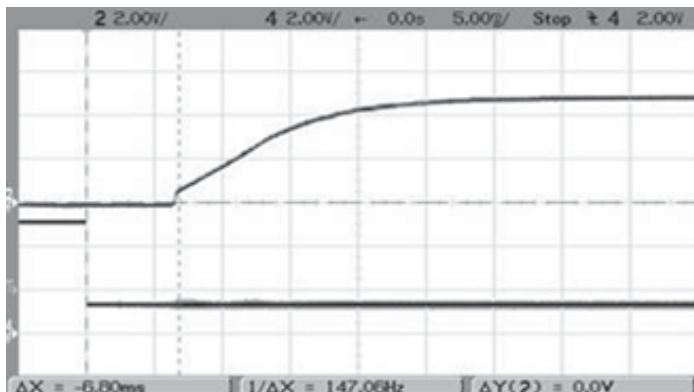

Vin Startup Delay (Vin = 48V, Vout = nom, Iout = 20A, Cload = 330uF, Ta = +25°C)
Ch1 = Vin, Ch2 = Vout.

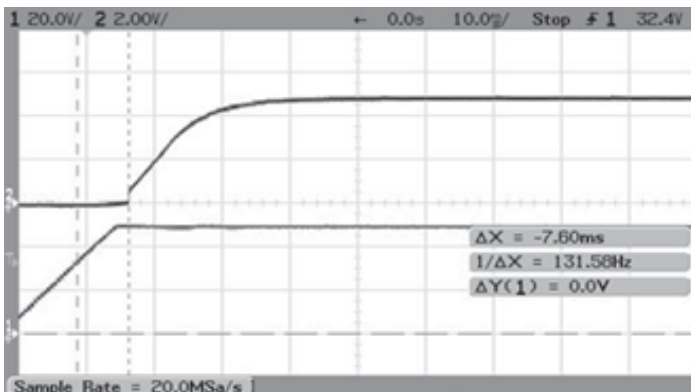

Step Load Transient Response (Vin = 48V, Vout = nom, Iout = 75%-50%
of full load, Ta = +25°C)

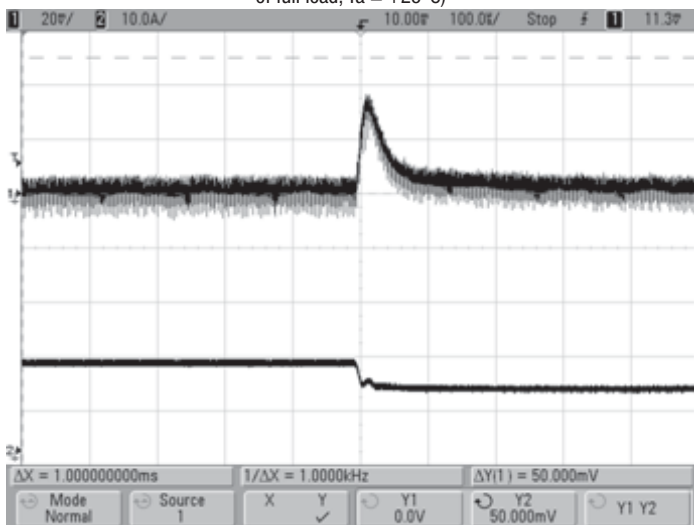

Step Load Transient Response (Vin = 48V, Vout = nom, Iout = 50%-75%
of full load, Ta = +25°C)

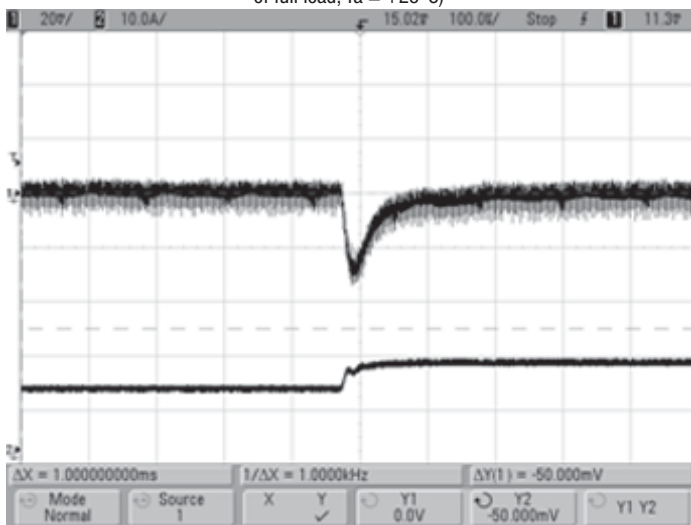

Step Load Transient Response (Vin = 48V, Vout = nom, Iout = 50%-75%-50%
of full load, Ta = +25°C)

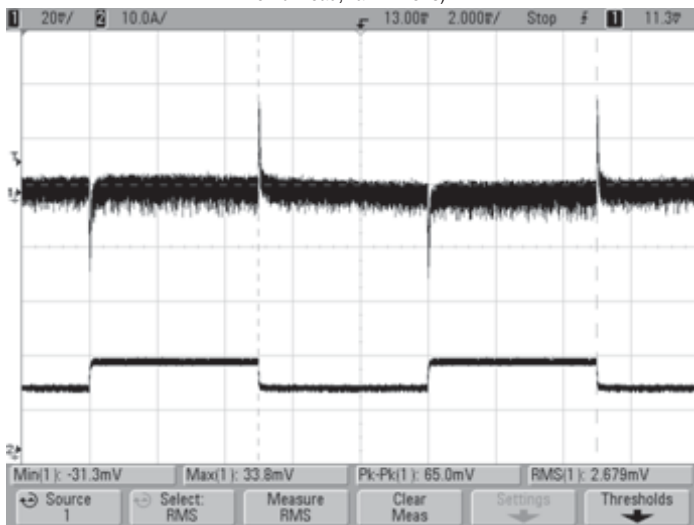

Thermal image with hot spot at full load (20A) current with 30°C ambient; air is flowing at 100 LFM. Air is flowing across the converter from Vin to Vout at 48V input. Identifiable and recommended maximum value to be verified in application. Hottest spot is Q4 = 103.4°C.

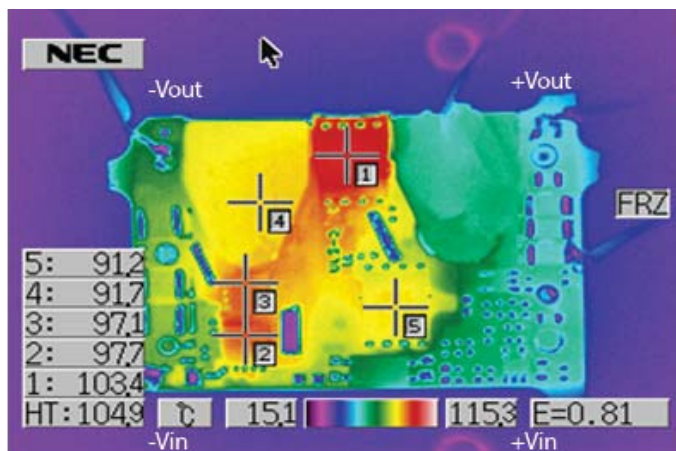

Emissions Performance, Model ULS-5/20-D48

Murata Power Solutions measures its products for radio frequency emissions against the EN 55022 and CISPR 22 standards. Passive resistance loads are employed and the output is set to the maximum voltage. If you set up your own emissions testing, make sure the output load is rated at continuous power while doing the tests.

The recommended external input and output capacitors (if required) are included. Please refer to the fundamental switching frequency. All of this information is listed in the Product Specifications. An external discrete filter is installed and the circuit diagram is shown below.

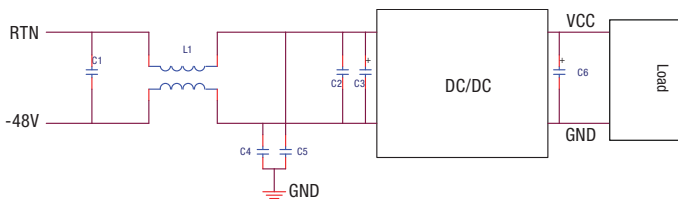

Figure 2. Conducted Emissions Test Circuit

[1] Conducted Emissions Parts List

[2] Conducted Emissions Test Equipment Used

Hewlett Packard HP8594L Spectrum Analyzer –S/N 3827A00153

2Line V-networks LS1-15V 50Ω/50uH Line Impedance Stabilization Network

[3] Conducted Emissions Test Results

Reference	Part Number	Description	Vendor
C1	GRM32ER-72A105KA01L	SMD CERAMIC-100V-1000nF-X7R-1210	Murata
C2	GRM-319R72A104KA01D	SMD CERAMIC 100V-100nF-±10%-X7R-1206	Murata
L1	LB16H1324	COMMON MODE-1320uH-±25%-4A-R5K-21*21*12.5mm	High Light
C4, C5	GRM-32DR73A223KW01L	SMD CERAMIC 1000V-0.022uF-±10%-X7R-1210	Murata
C3	UHE2A221MHD	Aluminum 100V-320Uf-±10%-long lead	Nichicon
C6	NA		

[4] Layout Recommendations

Most applications can use the filtering which is already installed inside the converter or with the addition of the recommended external capacitors. For greater emissions suppression, consider additional filter components and/or shielding. Emissions performance will depend on the user's PC board layout, the chassis shielding environment and choice of external components. Please refer to Application Note GEANO2 for further discussion.

Since many factors affect both the amplitude and spectra of emissions, we recommend using an engineer who is experienced at emissions suppression.

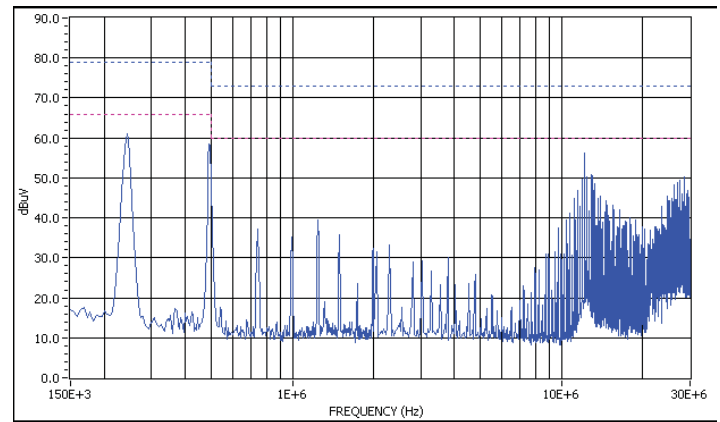

Peak Detection Value

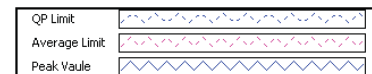

Graph 1. Conducted emissions performance, Positive Line, CISPR 22, Class A, 48Vin, full load

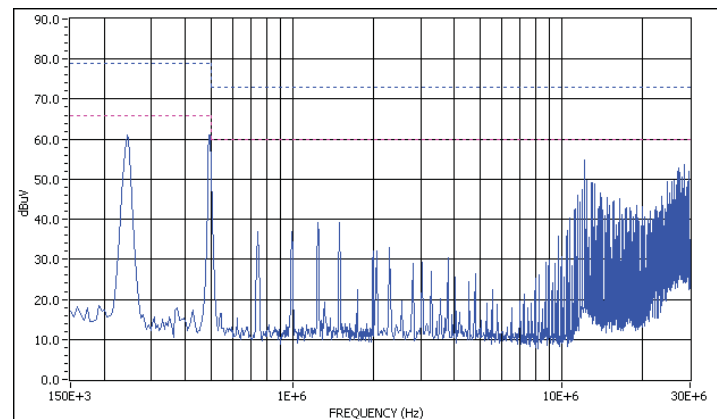

Peak Detection Value

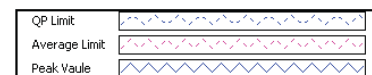

Graph 2. Conducted emissions performance, Negative Line, CISPR 22, Class A, 48Vin, full load

Contact Murata Power Solutions for Class B Emissions test circuit and conducted emissions performance test results.

FUNCTIONAL SPECIFICATIONS, ULS-12/8.3-D48

ABSOLUTE MAXIMUM RATINGS	Conditions ①	Minimum	Typical/Nominal	Maximum	Units
Input Voltage, Continuous		0		80	Vdc
Input Voltage, Transient	100 mS max. duration			100	Vdc
Isolation Voltage	Input to output, continuous			2250	Vdc
Input Reverse Polarity	None, install external fuse		None		Vdc
On/Off Remote Control	Power on, referred to -Vin	0		15	Vdc
Output Power		0		100.6	W
Output Current	Current-limited, no damage, short-circuit protected	0		8.3	A
Storage Temperature Range	Vin = Zero (no power)	-55		125	°C
Absolute maximums are stress ratings. Exposure of devices to greater than any of these conditions may adversely affect long-term reliability. Proper operation under conditions other than those listed in the Performance/Functional Specifications Table is not implied or recommended.					
INPUT					
Operating voltage range		36	48	75	Vdc
Recommended External Fuse	Fast blow			10	A
Start-up threshold	Rising input voltage	32.5	34.5	35.5	Vdc
Undervoltage shutdown	Falling input voltage	31	32.5	34	Vdc
Overvoltage shutdown			None		Vdc
Reverse Polarity Protection	None, install external fuse		None		Vdc
Internal Filter Type			C		
Input current					
Full Load Conditions	Vin = nominal		2.26	2.35	A
Low Line	Vin = minimum		3.01	3.14	A
Inrush Transient			0.05		A ² -Sec.
Short Circuit Input Current			.1	100	mA
No Load Input Current	Iout = minimum, unit = ON		50	150	mA
Shut-Down Input Current (Off)			5	10	mA
Reflected (back) ripple current ②	Measured at input with specified filter		15	30	mA, p-p
GENERAL and SAFETY					
Efficiency	Vin = 48V, full load	89	92		%
	Vin = min., full load	89	92		%
Isolation					
Isolation Voltage	Input to output, continuous		2250		Vdc
Insulation Safety Rating			basic		
Isolation Resistance			100		MΩ
Isolation Capacitance			3300		pF
Safety	Certified to UL-60950-1, CSA-C22.2 No. 60950-1, IEC/EN60950-1, 2nd edition		Yes		
Calculated MTBF	Per Telcordia SR332, issue 1, class 3, ground fixed, Tambient = +25°C		2.6		Hours x 10 ⁶
DYNAMIC CHARACTERISTICS					
Fixed Switching Frequency		470	520	570	KHz
Startup Time	Power on to Vout regulated			20	mS
Startup Time	Remote ON to Vout regulated			20	mS
Dynamic Load Response	50-75-50% load step, settling time to within 1% of Vout			100	μSec
Dynamic Load Peak Deviation	same as above		±180	±240	mV
FEATURES and OPTIONS					
Remote On/Off Control					
"N" suffix:					
Negative Logic, ON state	ON = Ground pin or external voltage	-0.1		0.8	V
Negative Logic, OFF state	OFF = Pin open or external voltage	2.5		15	V
Control Current	Open collector/drain		1	2	mA
"P" suffix:					
Positive Logic, ON state	ON = Pin open or external voltage	3.5		15	V
Positive Logic, OFF state	OFF = Ground pin or external voltage	0		1	V
Control Current	Open collector/drain		1	2	mA
SMT Mounting	"M" suffix				
Remote Sense	Sense pins connected externally to respective Vout pins			10	%

FUNCTIONAL SPECIFICATIONS, ULS-12/8.3-D48 (CONT.)

OUTPUT	Conditions ①	Minimum	Typical/Nominal	Maximum	Units
Total Output Power	See Derating	98.6	99.6	100.6	W
Voltage					
Nominal Output Voltage	No trim	11.88	12	12.12	Vdc
Setting Accuracy	At 50% load, no trim	-1		1	% of Vnom
Output Voltage Range	User-adjustable	-10		10	% of Vnom.
Overvoltage Protection	Via magnetic feedback	13.3	14.5	18	Vdc
Current					
Output Current Range		0	8.3	8.3	A
Minimum Load					
Current Limit Inception	98% of Vnom., after warmup	9	10.5	12.5	A
Short Circuit					
Short Circuit Current	Hiccup technique, autorecovery within ±1.25% of Vout		0.6		A
Short Circuit Duration (remove short for recovery)	Output shorted to ground, no damage		Continuous		
Short circuit protection method	Current limiting				
Regulation					
Line Regulation	Vin = min. to max., Vout = nom., Iout = nom.			±0.125	% of Vout
Load Regulation	Iout = min. to max., Vin = 48V			±0.25	% of Vout
Ripple and Noise	5 Hz- 20 MHz BW		80	150	mV pk-pk
Temperature Coefficient	At all outputs		±0.02		% of Vout./°C
Maximum Capacitive Loading	Low ESR, resistive load only	220		3300	µF
MECHANICAL (Through Hole Models)					
Outline Dimensions			1.3X0.9X0.4		Inches
(Please refer to outline drawing)	LxWxH		33X22.9X10.2		mm
Weight			0.56		Ounces
			16		Grams
Through Hole Pin Diameter			0.04 & 0.06		Inches
			1.016X1.524		mm
Through Hole Pin Material			Copper alloy		
TH Pin Plating Metal and Thickness	Nickel subplate		50		µ-inches
	Gold overplate		5		µ-inches
ENVIRONMENTAL					
Operating Ambient Temperature Range	With Derating	-40		85	°C
Operating Case Temperature Range	No derating	-40		120	°C
Storage Temperature	Vin = Zero (no power)	-55		125	°C
Thermal Protection/Shutdown	Measured in center	115	125	130	°C
Electromagnetic Interference	External filter is required				
Conducted, EN55022/CISPR22			B		Class
Radiated, EN55022/CISPR22			B		Class
Relative humidity, non-condensing	To +85°C	10		90	%RH
Altitude	must derate -1%/1000 feet	-500		10,000	feet
		-152		3048	meters
RoHS rating			RoHS-6		

Functional Specification Notes

- ① All specifications are typical unless noted. Ambient temperature = +25°Celsius, V_{IN} is nominal, output current is maximum rated nominal. External output capacitance is 1 μ F multilayer ceramic paralleled with 10 μ F electrolytic. All caps are low ESR. These capacitors are necessary for our test equipment and may not be needed in your application. Testing must be kept short enough that the converter does not appreciably heat up during testing. For extended testing, use plenty of airflow. See Derating Curves for temperature performance. All models are stable and regulate within spec without external capacitance.
- ② Input Ripple Current is tested and specified over a 5-20 MHz bandwidth and uses a special set of external filters only for the Ripple Current specifications. Input filtering is $C_{IN} = 33 \mu$ F, $C_{BUS} = 220 \mu$ F, $L_{BUS} = 12 \mu$ H. Use capacitor rated voltages which are twice the maximum expected voltage. Capacitors must accept high speed AC switching currents.
- ③ Note that Maximum Current Derating Curves indicate an average current at nominal input voltage. At higher temperatures and/or lower airflow, the converter will tolerate brief full current outputs if the average RMS current over time does not exceed the Derating curve. All Derating curves are presented at sea level altitude. Be aware of reduced power dissipation with increasing density altitude.
- ④ Mean Time Before Failure (MTBF) is calculated using the Telcordia (Belcore) SR-332 Method 1, Case 3, Issue 1, ground fixed conditions. Operating temperature = +25°C, full output load, natural air convection.
- ⑤ The output may be shorted to ground indefinitely with no damage. The Output Short Circuit Current shown in the specifications is an average consisting of very short bursts of full rated current to test whether the output circuit can be repowered.
- ⑥ The On/Off Control is normally driven from a switch or relay. An open collector/open drain transistor may be used in saturation and cut-off (pinch-off) modes. External logic may also be used if voltage levels are fully compliant to the specifications.
- ⑦ Regulation specifications describe the deviation as the input line voltage or output load current is varied from a nominal midpoint value to either extreme (50% load).
- ⑧ Do not exceed maximum power ratings, Sense limits or output overvoltage when adjusting output trim values.
- ⑨ At zero output current, V_{out} may contain components which slightly exceed the ripple and noise specifications.
- ⑩ Output overload protection is non-latching. When the output overload is removed, the output will automatically recover.
- ⑪ All models are fully operational and meet published specifications, including "cold start" at -40°C.
- ⑫ The converter will shut off if the input falls below the undervoltage threshold. It will not restart until the input exceeds the Input Start Up Voltage.
- ⑬ Short circuit shutdown begins when the output voltage degrades approximately 2% from the selected setting.
- ⑭ Output noise may be further reduced by installing an external filter. See the Application Notes. Use only as much output filtering as needed ***and no more***. Larger caps (especially low-ESR ceramic types) may slow transient response or degrade dynamic performance. Thoroughly test your application with all components installed.
- ⑮ To avoid damage or unplanned shutdown, do not sink appreciable reverse output current.
- ⑯ A fast blow fuse must be installed in series with + V_{in} to avoid damage to the converter in the event that the source voltage is accidentally applied to the converter with reverse polarity.
- ⑰ Although extremely unlikely, failure of the internal components of this product may expose external application circuits to dangerous voltages, currents, temperatures or power levels. Please thoroughly verify all applications before committing them to service. Be sure to include appropriately rated FUSES (see specifications and Application Notes) to reduce the risk of failure.
- ⑱ If Sense is not wired to an external load, connect sense pins to their respective V_{out} pins. Do not leave sense unconnected.
- ⑲ The switching frequencies of these converters are fixed; see individual specifications for model details.

TYPICAL PERFORMANCE DATA, ULS-12/8.3-D48

Efficiency and Power Dissipation

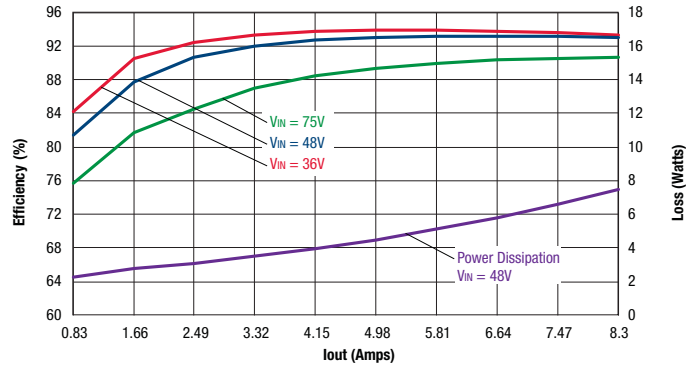

Maximum Current Temperature Derating at Sea Level
(V_{IN} = 48V, airflow is from Vin- to Vin+)

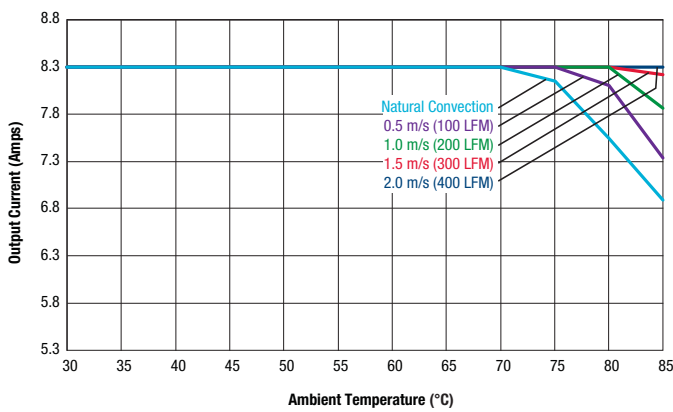

Maximum Current Temperature Derating at Sea Level
(V_{IN} = 48V, airflow is from Vin to Vout)

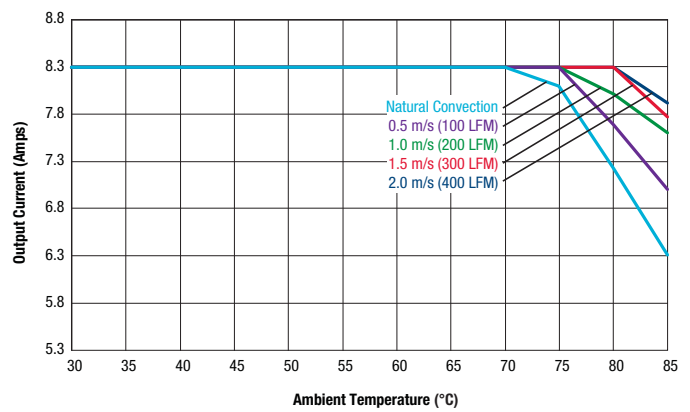

Output ripple and Noise (V_{in}=48V, I_{out}=0, Load= 1uF || 10uF, T_a=+25°C)
V_{out} ripple=61mV

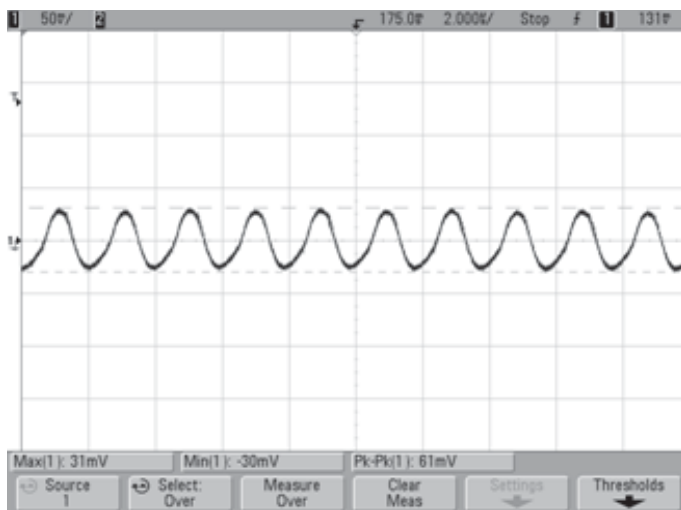

Output ripple and Noise (V_{in}=48V, I_{out}=8.3A, Load= 1uF || 10uF, T_a=+25°C)
V_{out} ripple=66mV

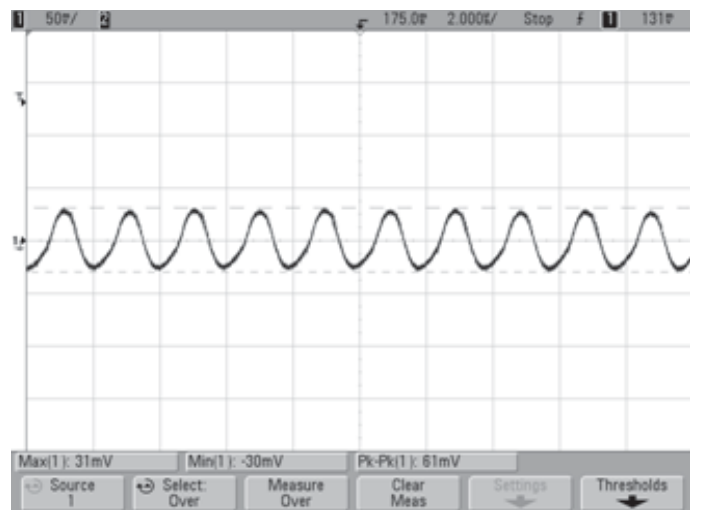

TYPICAL PERFORMANCE DATA, ULS-12/8.3-D48

Enable Startup Delay (Vin=48V, Iout=8.3A, Cload=3300uF, Ta=+25°C) Trace 2=Vout, Trace 4=Enable

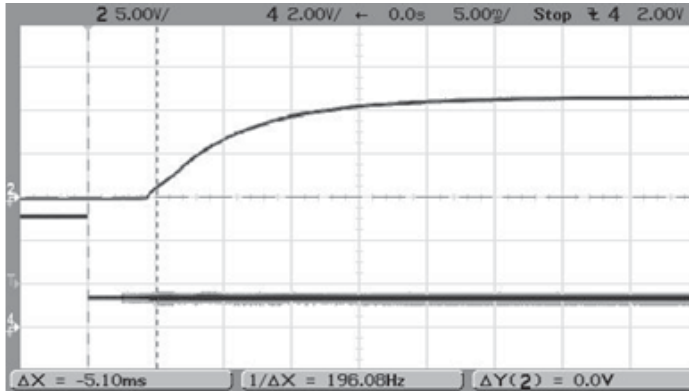

Startup Delay (Vin=48V, Iout=8.3A, Cload=3300uF, Ta=+25°C) Trace 1=Vin, Trace 2=Vout

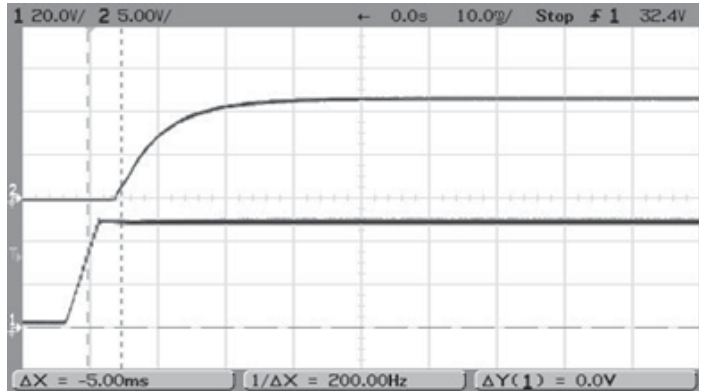

Step Load Transient Response (Vin=48V, Vout=nom, Iout= 75% to 50% of full load, 1A/uS at Ta=+25°C) +Delta=166mV, Recovery time=11.8uS

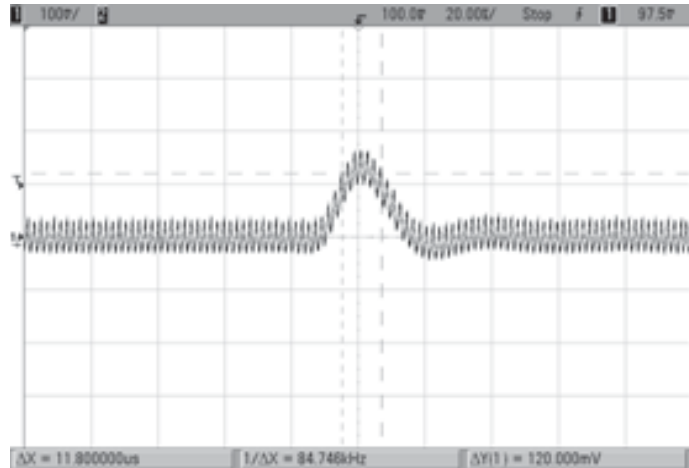

Step Load Transient Response (Vin=48V, Vout=nom, Iout= 50% to 75% of full load, 1A/uS at Ta=+25°C) +Delta=172mV, Recovery time=12uS

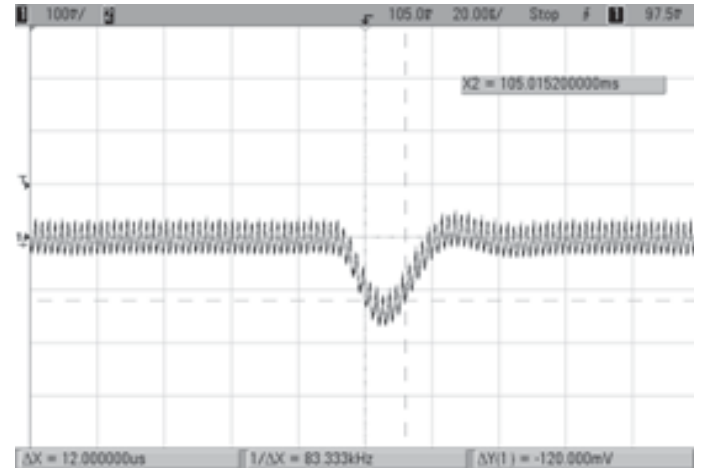

Step Load Transient Response (Vin=48V, Vout=nom, Iout= 50% to 75% of full load, 1A/uS at Ta=+25°C)

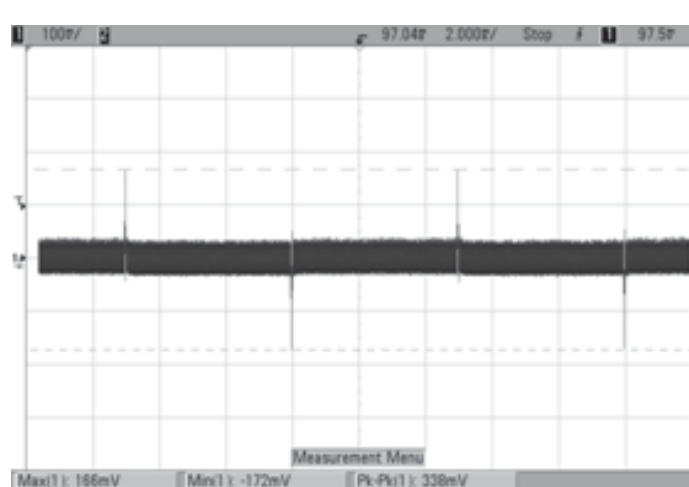

Thermal image with hot spot at full load current (8.3A) with 30°C ambient; air is flowing at 100 LFM. Air is flowing across the converter from Vin to Vout at 48V input. Identifiable and recommended maximum value to be verified in application. Hottest spot is Q4=86.2°C.

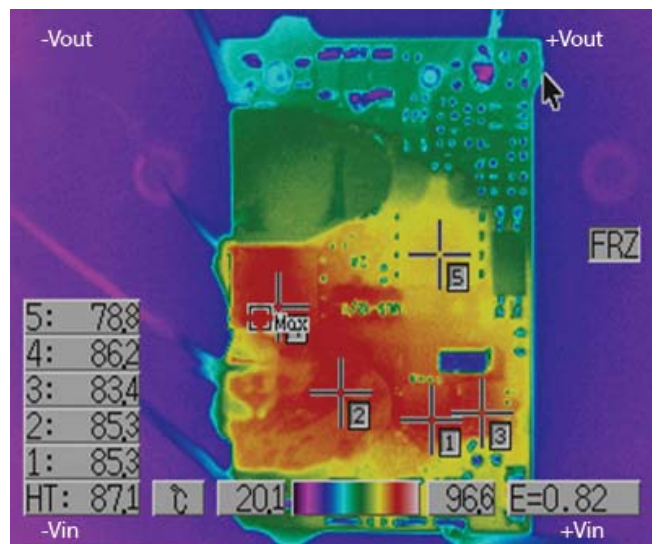

Emissions Performance, Model ULS-12/8.3-D48

Murata Power Solutions measures its products for radio frequency emissions against the EN 55022 and CISPR 22 standards. Passive resistance loads are employed and the output is set to the maximum voltage. If you set up your own emissions testing, make sure the output load is rated at continuous power while doing the tests.

The recommended external input and output capacitors (if required) are included. Please refer to the fundamental switching frequency. All of this information is listed in the Product Specifications. An external discrete filter is installed and the circuit diagram is shown below.

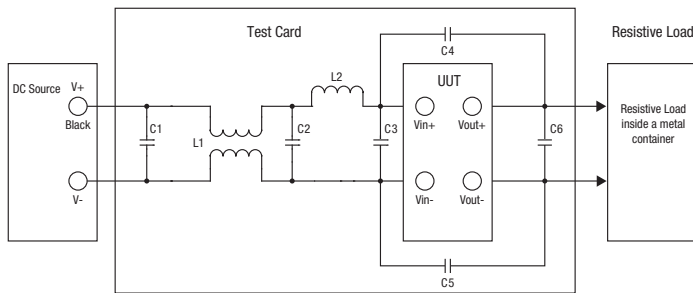

Figure 9. Conducted Emissions Test Circuit

[1] Conducted Emissions Parts List

Reference	Part Number	Description	Vendor
C1	GRM32ER72A105KA01L	SMD CERAMIC 100V-1000nF-X7R-1210	Murata
C2	GRM319R72A104KA01D	SMD CERAMIC 100V-100nF-±10%-X7R-1206	Murata
L1	LB16H1324	COMMON MODE 1320uH-±25%-4A-R5K-21 *21*12.5mm	High Light
C4, C5	GRM32DR73A223KW01L	SMD CERAMIC 1000V-0.022uF-±10%-X7R-1210	Murata
C3	UHE2A221MHD	Aluminum 100V-320uF-±10%-long lead	Nichicon
C6	NA		

[2] Conducted Emissions Test Equipment Used

Hewlett Packard HP8594L Spectrum Analyzer –S/N 3827A00153
2Line V-networks LS1-15V 50Ω /50Uh Line Impedance Stabilization Network

[3] Layout Recommendations

Most applications can use the filtering which is already installed inside the converter or with the addition of the recommended external capacitors. For greater emissions suppression, consider additional filter components and/or shielding. Emissions performance will depend on the user's PC board layout, the chassis shielding environment and choice of external components. Please refer to Application Note GEAN-02 for further discussion.

Since many factors affect both the amplitude and spectra of emissions, we recommend using an engineer who is experienced at emissions suppression.

[3] Conducted Emissions Test Results

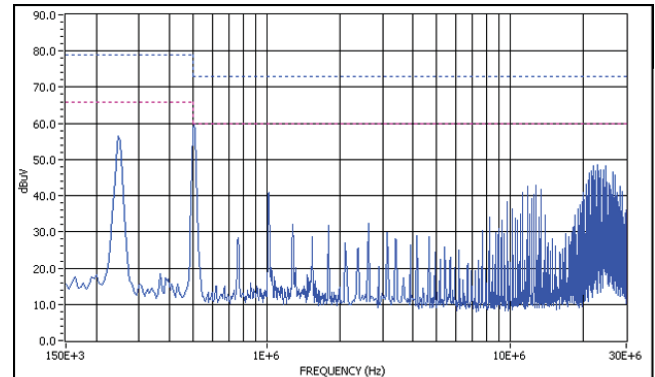

Peak Detection Value

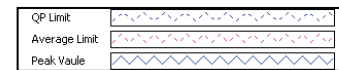

Graph 3. Conducted emissions performance, Positive Line, CISPR 22, Class A, 48Vin, full load

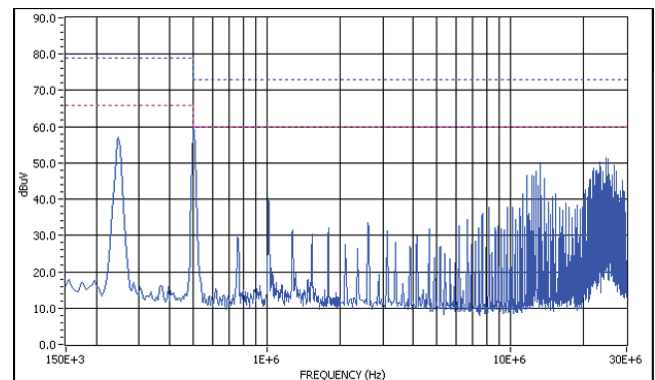

Peak Detection Value

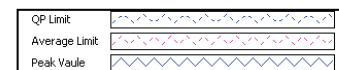

Graph 4. Conducted emissions performance, Negative Line, CISPR 22, Class A, 48Vin, full load

MECHANICAL SPECIFICATIONS, THROUGH-HOLE MOUNT

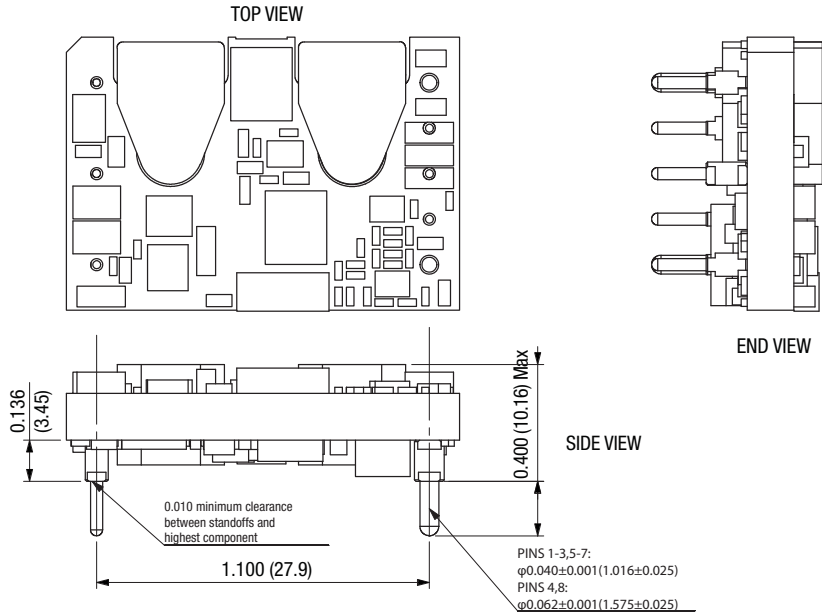

INPUT/OUTPUT CONNECTIONS			
Pin	Function	Pin	Function
3	-Vin	4	-Vout
		5	-Sense
2	On/Off Control	6	Trim
		7	+Sense
1	+Vin	8	+Vout

Important! **Always** connect the sense pins. If they are not connected to a remote load, wire each sense pin to its respective voltage output at the converter pins.

The 0.145-inch pin length is shown. Please refer to the part number structure for alternate pin lengths. Pin material: Copper alloy. Plating: Gold over nickel

Please note that some competitive units may use different pin numbering or alternate outline views; however, all units are plugin-compatible.

It is recommended that no parts be placed beneath the converter

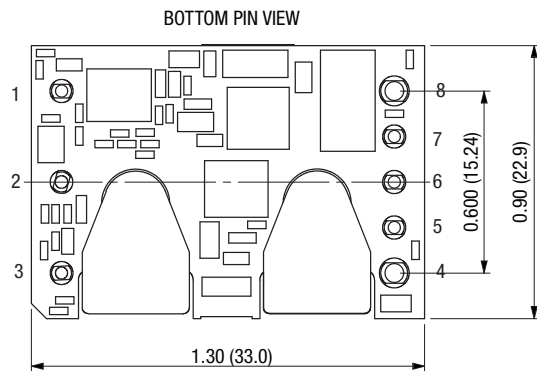

Standard pin length 0.180 in.
For L2 pin length option in model no., cut the pin length to 0.145 in.

Dimensions are in inches (mm) shown for ref. only.

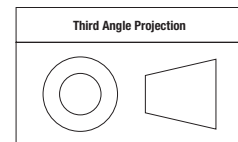

Tolerances (unless otherwise specified):
.XX ± 0.02 (0.5)
.XXX ± 0.010 (0.25)
Angles ± 2°

Components are shown for reference only and may vary between units.

**RECOMMENDED FOOTPRINT
(VIEW THROUGH CONVERTER)**

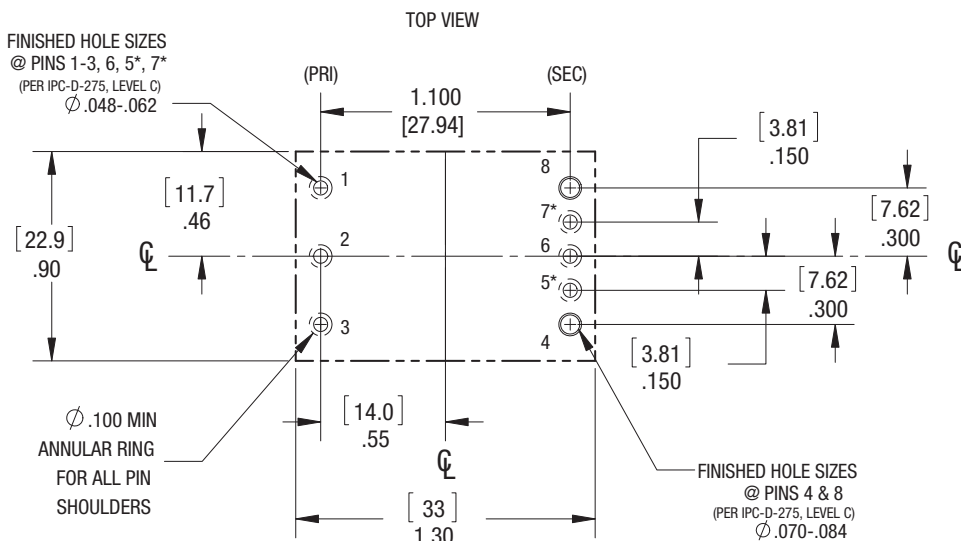

SHIPPING TRAYS AND BOXES, THROUGH-HOLE MOUNT

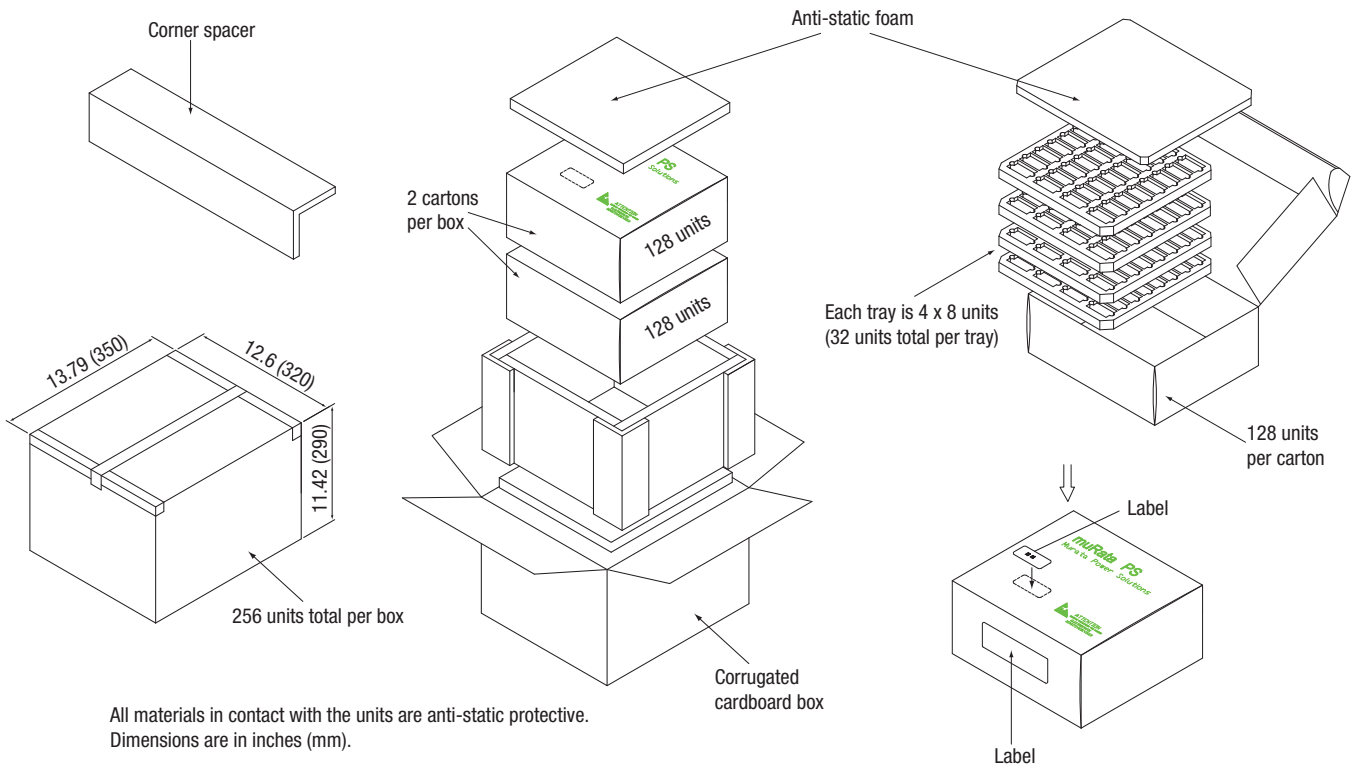

SHIPPING TRAY DIMENSIONS

Material: Low density, closed cell polyethylene anti-static foam

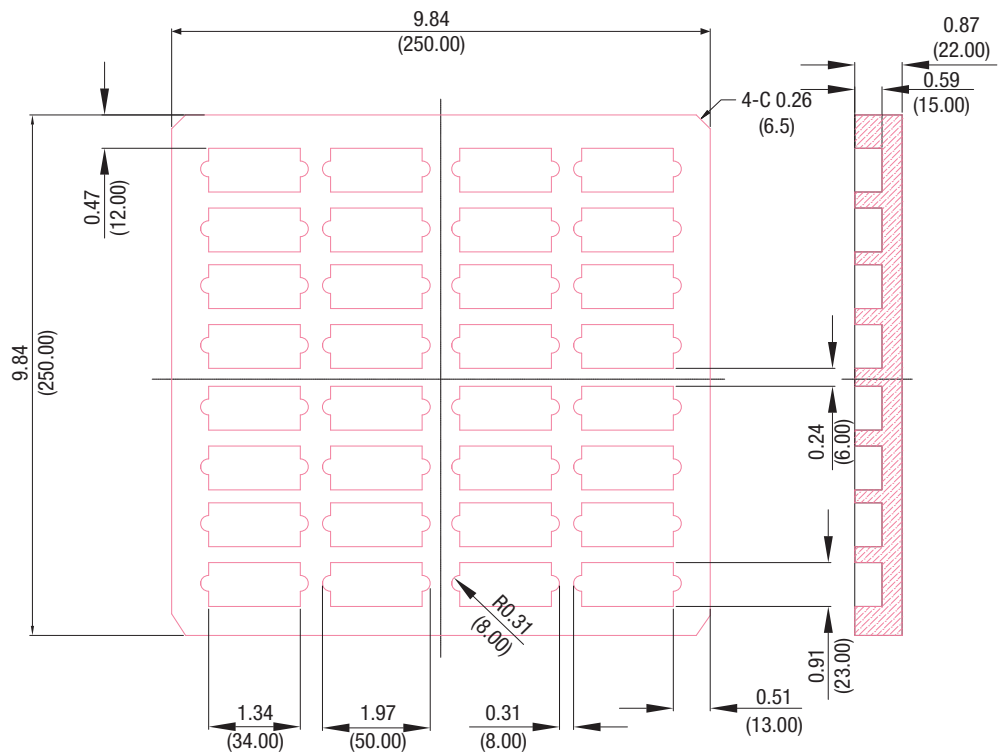

Dimensions are in millimeters.

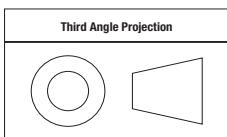

Tolerances (unless otherwise specified):
.XX ± 0.5
.XXX ± 0.25
Angles ± 2°

MECHANICAL SPECIFICATIONS, SURFACE MOUNT (MSL RATING 2a).

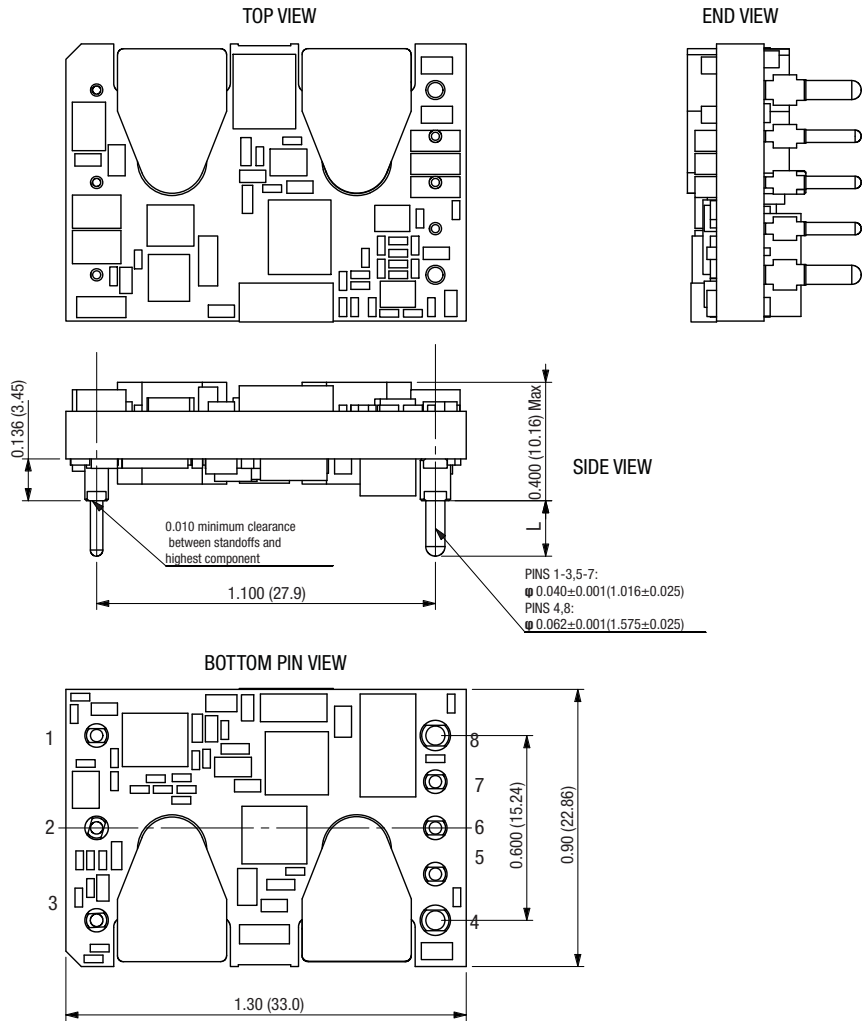

INPUT/OUTPUT CONNECTIONS			
Pin	Function	Pin	Function
3	-Vin	4	-Vout
		5	-Sense
2	On/Off Control	6	Trim
		7	+Sense
1	+Vin	8	+Vout

Important! **Always** connect the sense pins. If they are not connected to a remote load, wire each sense pin to its respective voltage output at the converter pins.

Pin material: Copper alloy. Plating: Gold over nickel

Please note that some competitive units may use different pin numbering or alternate outline views; however, all units are plugin-compatible.

It is recommended that no parts be placed beneath the converter

Dimensions are in inches (mm) shown for ref. only.

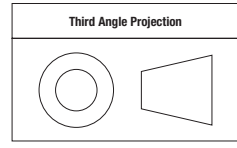

Tolerances (unless otherwise specified):
 .XX ± 0.02 (0.5)
 .XXX ± 0.010 (0.25)
 Angles ± 2°

Components are shown for reference only and may vary between units.

**RECOMMENDED FOOTPRINT
(VIEW THROUGH CONVERTER)**

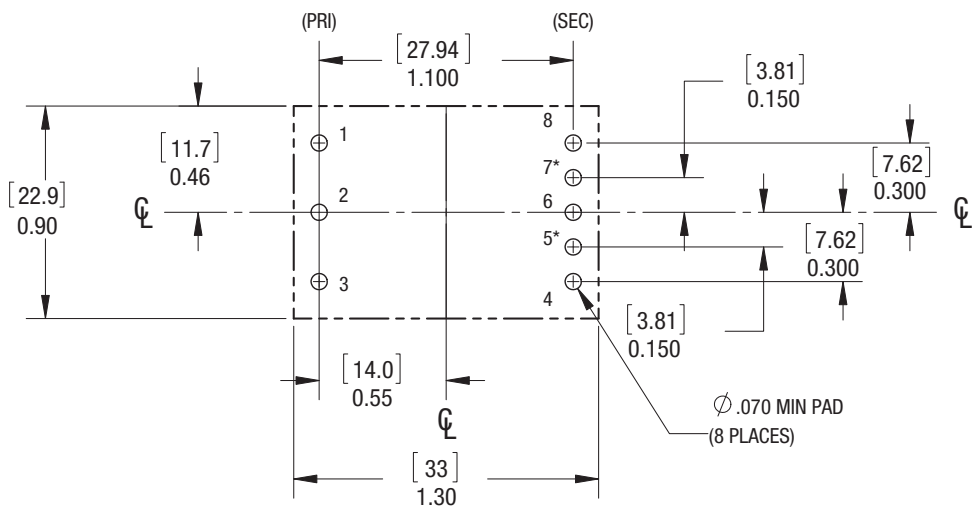

TAPE AND REEL INFORMATION

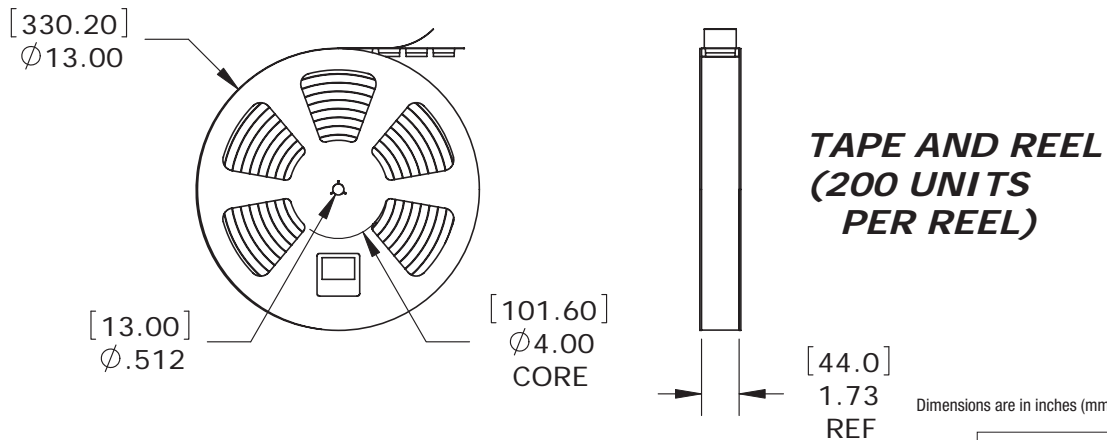
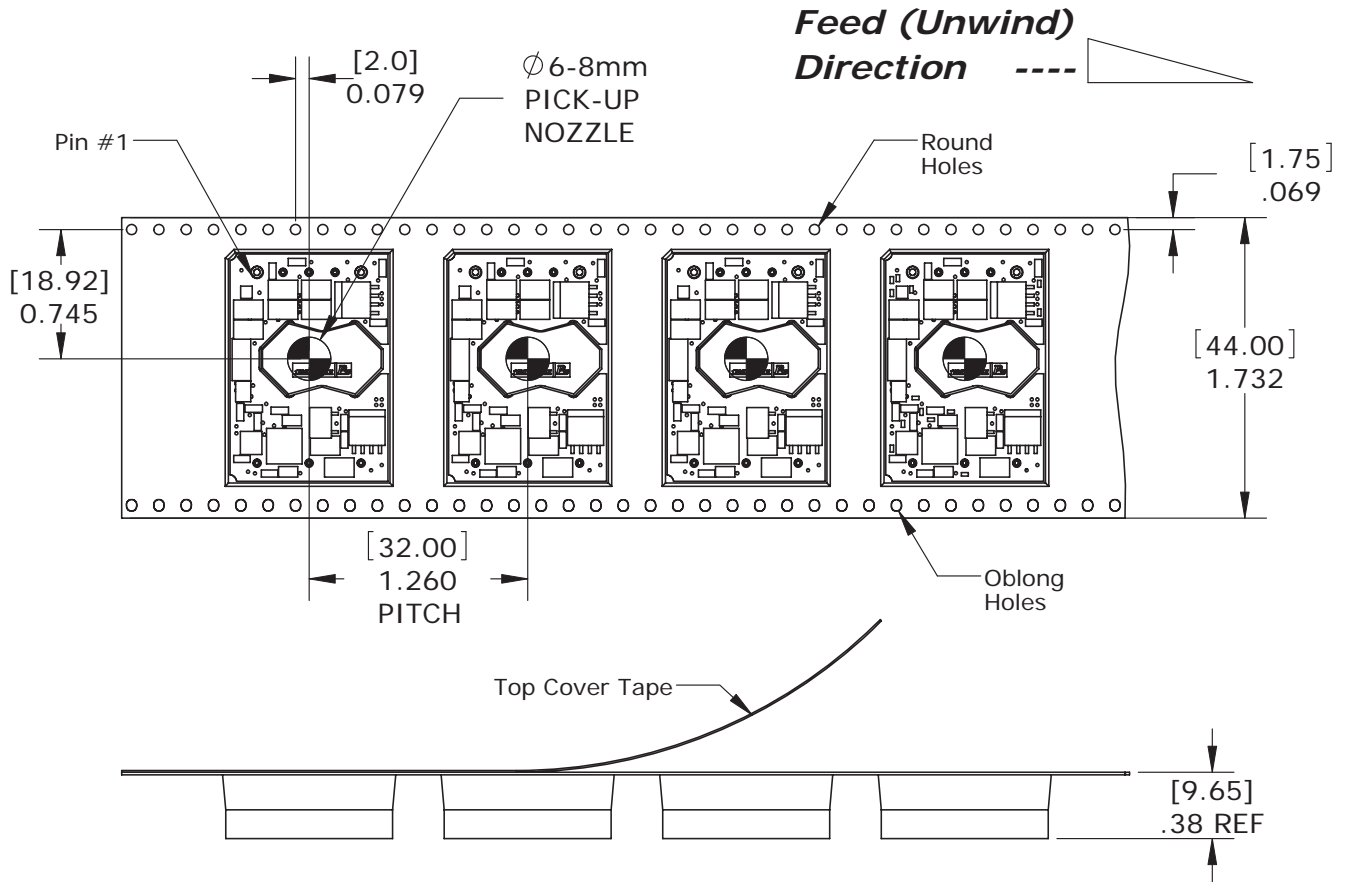

Dimensions are in inches (mm shown for ref. only).

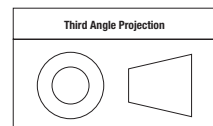

Tolerances (unless otherwise specified):
 .XX ± 0.02 (0.5)
 .XXX ± 0.010 (0.25)
 Angles ± 1°

Components are shown for reference only.

TECHNICAL NOTES

Input Fusing

Certain applications and/or safety agencies may require the installation of fuses at the inputs of power conversion components. Fuses should also be used if the possibility of sustained, non-current-limited, input-voltage polarity reversals exists. For DATEL ULS series DC-DC converters, we recommend the use of a fast blow fuse, installed in the ungrounded input supply line with a typical value about twice the maximum input current, calculated at low line with the converter's minimum efficiency.

All relevant national and international safety standards and regulations must be observed by the installer. For system safety agency approvals, the converters must be installed in compliance with the requirements of the end-use safety standard.

Input Reverse-Polarity Protection

If the input voltage polarity is accidentally reversed, an internal diode will become forward biased and likely draw excessive current from the power source. If this source is not current limited or the circuit appropriately fused, it could cause permanent damage to the converter.

Input Under-Voltage Shutdown and Start-Up Threshold

Under normal start-up conditions, devices will not begin to regulate properly until the ramping-up input voltage exceeds the Start-Up Threshold Voltage. Once operating, devices will not turn off until the input voltage drops below the Under-Voltage Shutdown limit. Subsequent re-start will not occur until the input is brought back up to the Start-Up Threshold. This built-in hysteresis prevents any unstable on/off situations from occurring at a single input voltage.

Start-Up Time

The V_{IN} to V_{OUT} Start-Up Time is the time interval between the point at which the ramping input voltage crosses the Start-Up Threshold and the fully loaded output voltage enters and remains within its specified accuracy band. Actual measured times will vary with input source impedance, external input capacitance, and the slew rate and final value of the input voltage as it appears at the converter. The ULS Series implements a soft start circuit to limit the duty cycle of its PWM controller at power up, thereby limiting the input inrush current.

The On/Off Control to V_{OUT} start-up time assumes the converter has its nominal input voltage applied but is turned off via the On/Off Control pin. The specification defines the interval between the point at which the converter is turned on (released) and the fully loaded output voltage enters and remains within its specified accuracy band. Similar to the V_{IN} to V_{OUT} start-up, the On/Off Control to V_{OUT} start-up time is also governed by the internal soft start circuitry and external load capacitance. The difference in start up time from V_{IN} to V_{OUT} and from On/Off Control to V_{OUT} is therefore insignificant.

Input Source Impedance

The input of ULS converters must be driven from a low ac-impedance source. The DC-DC's performance and stability can be compromised by the use of highly inductive source impedances. The input circuit shown in Figure 2 is a practical solution that can be used to minimize the effects of inductance in the input traces. For optimum performance, components should be mounted close to the DC-DC converter.

I/O Filtering, Input Ripple Current, and Output Noise

All models in the ULS Series are tested/specified for input reflected ripple current and output noise using the specified external input/output components/circuits and layout as shown in the following two figures. External input capacitors (C_{IN} in Figure 2) serve primarily as energy-storage elements, minimizing line voltage variations caused by transient IR drops in conductors from backplane to the DC-DC. Input caps should be selected for bulk capacitance (at appropriate frequencies), low ESR, and high rms-ripple-current ratings. The switching nature of DC-DC converters requires that dc voltage sources have low ac impedance as highly inductive source impedance can affect system stability. In Figure 2, C_{BUS} and L_{BUS} simulate a typical dc voltage bus. Your specific system configuration may necessitate additional considerations.

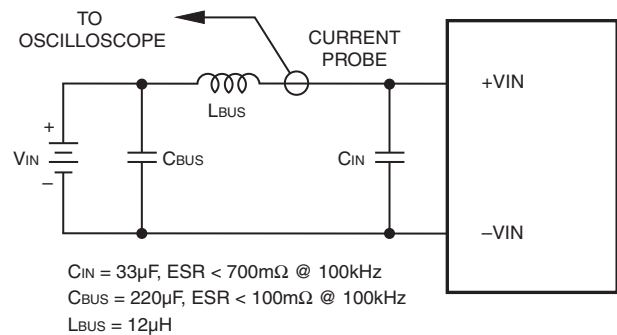

Figure 2. Measuring Input Ripple Current

In critical applications, output ripple/noise (also referred to as periodic and random deviations or PARD) may be reduced below specified limits using filtering techniques, the simplest of which is the installation of additional external output capacitors. They function as true filter elements and should be selected for bulk capacitance, low ESR and appropriate frequency response.

All external capacitors should have appropriate voltage ratings and be located as close to the converter as possible. Temperature variations for all relevant parameters should also be taken carefully into consideration. The most effective combination of external I/O capacitors will be a function of line voltage and source impedance, as well as particular load and layout conditions.

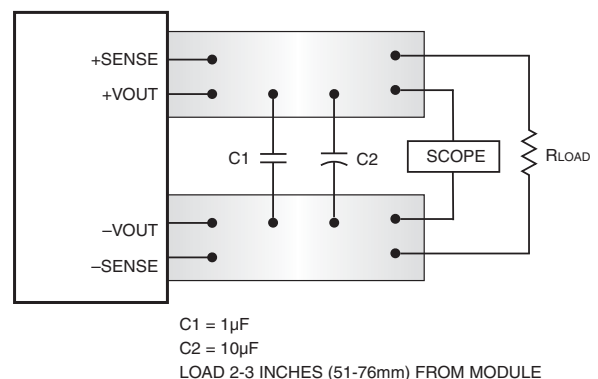

Figure 3. Measuring Output Ripple/Noise (PARD)

Floating Outputs

Since these are isolated DC-DC converters, their outputs are “floating” with respect to their input. Designers will normally use the –Output as the ground/return of the load circuit. You can however, use the +Output as ground/return to effectively reverse the output polarity.

Minimum Output Loading Requirements

ULS converters employ a synchronous-rectifier design topology and all models regulate within spec and are stable under no-load to full load conditions. Operation under no-load conditions however might slightly increase the output ripple and noise.

Thermal Shutdown

The ULS converters are equipped with thermal-shutdown circuitry. If environmental conditions cause the temperature of the DC-DC converter to rise above the designed operating temperature, a precision temperature sensor will power down the unit. When the internal temperature decreases below the threshold of the temperature sensor, the unit will self start. See Performance/Functional Specifications.

Output Over-Voltage Protection

The ULS output voltage is monitored for an over-voltage condition using a comparator. The signal is optically coupled to the primary side and if the output voltage rises to a level which could be damaging to the load, the sensing circuitry will power down the PWM controller causing the output voltage to decrease. Following a time-out period the PWM will restart, causing the output voltage to ramp to its appropriate value. If the fault condition persists, and the output voltage again climbs to excessive levels, the over-voltage circuitry will initiate another shutdown cycle. This on/off cycling is referred to as “hiccup” mode.

Current Limiting

As soon as the output current increases to approximately 130% of its rated value, the DC-DC converter will go into a current-limiting mode. In this condition, the output voltage will decrease proportionately with increases in output current, thereby maintaining somewhat constant power dissipation. This is commonly referred to as power limiting. Current limit inception is defined as the point at which the full-power output voltage falls below the specified tolerance. See Performance/Functional Specifications. If the load current, being drawn from the converter, is significant enough, the unit will go into a short circuit condition as described below.

Short Circuit Condition

When a converter is in current-limit mode, the output voltage will drop as the output current demand increases. If the output voltage drops too low, the magnetically coupled voltage used to develop primary side voltages will also drop, thereby shutting down the PWM controller. Following a time-out period, the PWM will restart causing the output voltage to begin ramping to their appropriate value. If the short-circuit condition persists, another shutdown cycle will be initiated. This on/off cycling is referred to as “hiccup” mode. The hiccup cycling reduces the average output current, thereby preventing internal temperatures from rising to excessive levels. The ULS Series is capable of enduring an indefinite short circuit output condition.

Remote Sense

Note: The Sense and V_{OUT} lines are internally connected through low-value resistors. Nevertheless, if the sense function is not used for remote regulation the user should connect the +Sense to +V_{OUT} and –Sense to –V_{OUT} at the DC-DC converter pins. ULS series converters employ a sense feature to provide point of use regulation, thereby overcoming moderate IR drops in PCB conductors or cabling. The remote sense lines carry very little current and therefore require minimal cross-sectional-area conductors. The sense lines, which are capacitively coupled to their respective output lines, are used by the feedback control-loop to regulate the output. As such, they are not low impedance points and must be treated with care in layouts and cabling. Sense lines on a PCB should be run adjacent to dc signals, preferably ground.

$$[V_{OUT(+)} - V_{OUT(-)}] - [Sense(+) - Sense(-)] \leq 10\% V_{OUT}$$

In cables and discrete wiring applications, twisted pair or other techniques should be used. Output over-voltage protection is monitored at the output voltage pin, not the Sense pin. Therefore, excessive voltage differences between V_{OUT} and Sense in conjunction with trim adjustment of the output voltage can cause the over-voltage protection circuitry to activate (see Performance Specifications for over-voltage limits). Power derating is based on maximum output current and voltage at the converter’s output pins. Use of trim and sense functions can cause output voltages to increase, thereby increasing output power beyond the converter’s specified rating, or cause output voltages to climb into the output over-voltage region. Therefore, the designer must ensure:

$$(V_{OUT \text{ at pins}}) \times (I_{OUT}) \leq \text{rated output power}$$

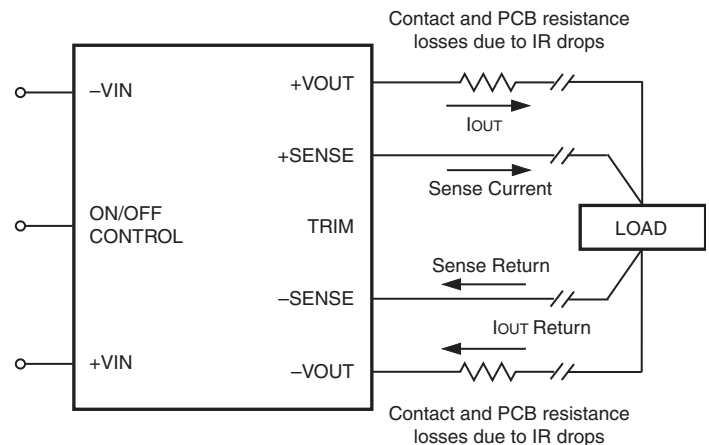

Figure 4. Remote Sense Circuit Configuration

On/Off Control

The input-side, remote On/Off Control function can be ordered to operate with either logic type:

Positive (“P” suffix) logic models are enabled when the on/off pin is left open (or is pulled high, applying +3.5V to +15V with respect to –Input) as per Figure 5. Positive-logic devices are disabled when the on/off pin is pulled low (0 to 1V with respect to –Input).

Negative (“N” suffix) logic devices are off when pin is left open (or pulled high, applying +2.5V to +15V), and on when pin is pulled low (–0.1 to +0.8V) with respect to –Input as shown in Figure 5.

Dynamic control of the remote on/off function is best accomplished with a mechanical relay or an open-collector/open-drain drive circuit (optically isolated if appropriate). The drive circuit should be able to sink appropriate current (see Performance Specifications) when activated and withstand appropriate voltage when deactivated. Applying an external voltage to pin 2 when no input power is applied to the converter can cause permanent damage to the converter.

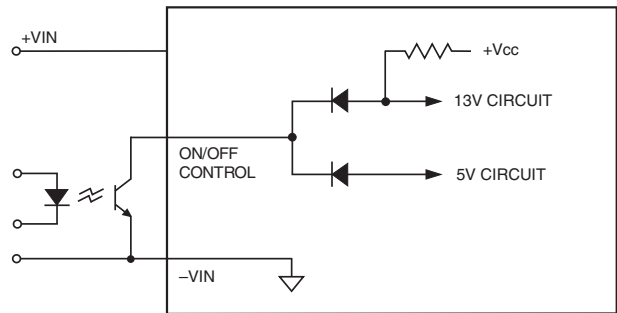

Figure 5. Driving the Negative Logic On/Off Control Pin (simplified circuit)

OUTPUT VOLTAGE ADJUSTMENT

Trim Equations

Trim Down

$$R_{T_DOWN} (k\Omega) = \frac{5.11}{\Delta} - 10.22$$

$$\text{Where } \Delta = \left| \frac{V_{OUT} - V_{NOM}}{V_{NOM}} \right|$$

Trim Up

$$R_{T_UP} (k\Omega) = \frac{5.11 \times V_{NOM} \times (1 + \Delta)}{1.225 \times \Delta} - \frac{5.11}{\Delta} - 10.22$$

$$\text{Where } \Delta = \left| \frac{V_{OUT} - V_{NOM}}{V_{NOM}} \right|$$

Note: "Δ" is always a positive value.
"V_{NOM}" is the nominal, rated output voltage.
"V_{OUT}" is the desired, changed output voltage.

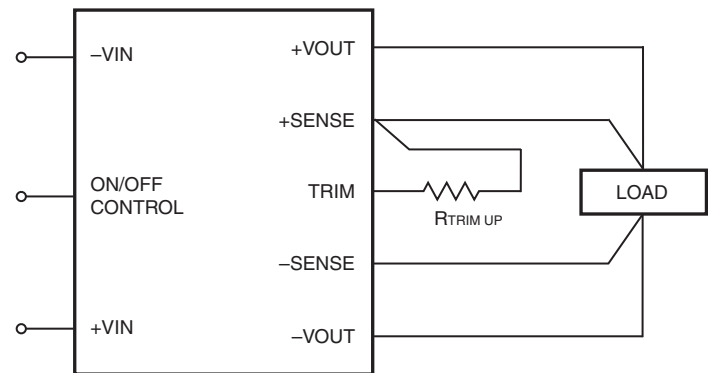

Figure 6. Trim Connections To Increase Output Voltages
Connect sense to its respective V_{OUT} pin if sense is not used with a remote load.

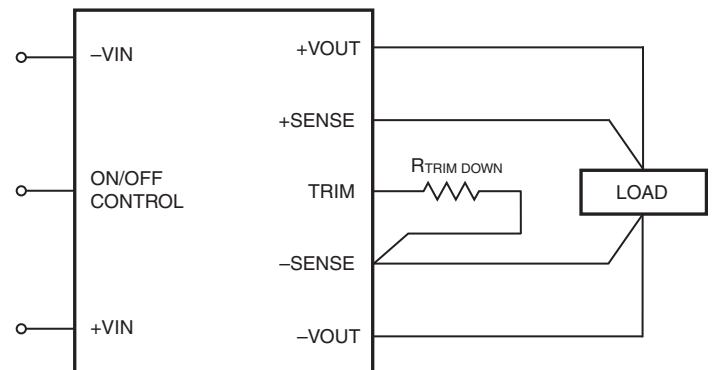

Figure 7. Trim Connections To Decrease Output Voltages

Through-hole Soldering Guidelines

Murata Power Solutions recommends the TH soldering specifications below when installing these converters. These specifications vary depending on the solder type. Exceeding these specifications may cause damage to the product. Your production environment may differ; therefore please thoroughly review these guidelines with your process engineers.

Wave Solder Operations for through-hole mounted products (THMT)	
For Sn/Ag/Cu based solders:	
Maximum Preheat Temperature	115° C.
Maximum Pot Temperature	270° C.
Maximum Solder Dwell Time	7 seconds
For Sn/Pb based solders:	
Maximum Preheat Temperature	105° C.
Maximum Pot Temperature	250° C.
Maximum Solder Dwell Time	6 seconds

SMT Reflow Soldering Guidelines

The surface-mount reflow solder profile shown below is suitable for SAC305 type lead-free solders. This graph should be used only as a **guideline**. Many other factors influence the success of SMT reflow soldering. Since your production environment may differ, please thoroughly review these guidelines with your process engineers.

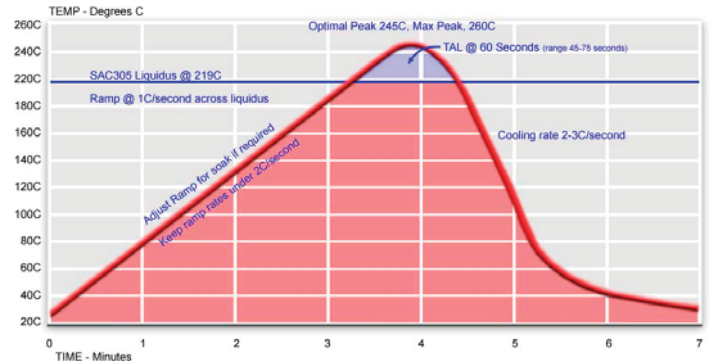

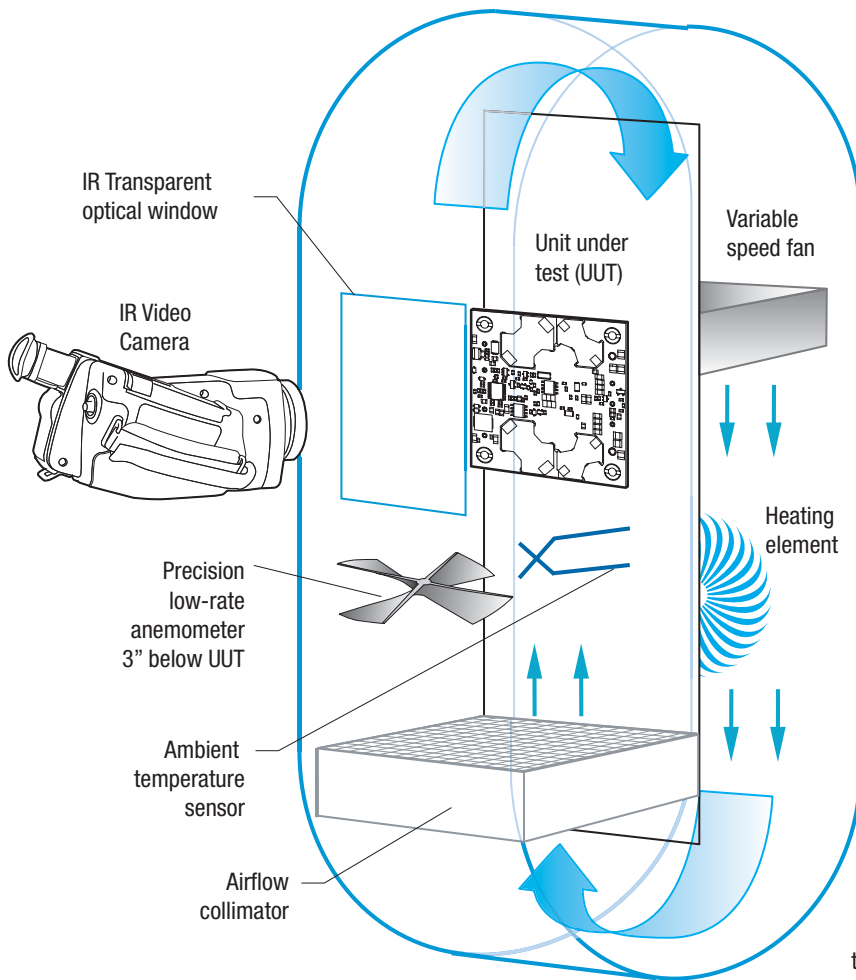

Figure 8. Vertical Wind Tunnel

Vertical Wind Tunnel

Murata Power Solutions employs a computer controlled custom-designed closed loop vertical wind tunnel, infrared video camera system, and test instrumentation for accurate airflow and heat dissipation analysis of power products. The system includes a precision low flow-rate anemometer, variable speed fan, power supply input and load controls, temperature gauges, and adjustable heating element.

The IR camera monitors the thermal performance of the Unit Under Test (UUT) under static steady-state conditions. A special optical port is used which is transparent to infrared wavelengths.

Both through-hole and surface mount converters are soldered down to a host carrier board for realistic heat absorption and spreading. Both longitudinal and transverse airflow studies are possible by rotation of this carrier board since there are often significant differences in the heat dissipation in the two airflow directions. The combination of adjustable airflow, adjustable ambient heat, and adjustable Input/Output currents and voltages mean that a very wide range of measurement conditions can be studied.

The collimator reduces the amount of turbulence adjacent to the UUT by minimizing airflow turbulence. Such turbulence influences the effective heat transfer characteristics and gives false readings. Excess turbulence removes more heat from some surfaces and less heat from others, possibly causing uneven overheating.

Both sides of the UUT are studied since there are different thermal gradients on each side. The adjustable heating element and fan, built-in temperature gauges, and no-contact IR camera mean that power supplies are tested in real-world conditions.



X-ON Electronics

Largest Supplier of Electrical and Electronic Components

Click to view similar products for [Isolated DC/DC Converters](#) category:

Click to view products by [Murata](#) manufacturer:

Other Similar products are found below :

[ESM6D044440C05AAQ](#) [FMD15.24G](#) [PSL486-7LR](#) [Q48T30020-NBB0](#) [JAHW100Y1](#) [SPB05C-12](#) [SQ24S15033-PS0S](#) [19-130041](#) [CE-1003](#)
[CE-1004](#) [GQ2541-7R](#) [RDS180245](#) [MAU228](#) [DFC15U48D15](#) [XGS-0512](#) [XGS-1205](#) [XGS-1212](#) [XGS-2412](#) [XGS-2415](#) [XKS-1215](#) [06322](#)
[NCT1000N040R050B](#) [SPB05B-15](#) [SPB05C-15](#) [L-DA20](#) [DCG40-5G](#) [QME48T40033-PGB0](#) [XKS-2415](#) [XKS-2412](#) [XKS-2405](#) [XKS-1212](#)
[XKS-1205](#) [XKS-0515](#) [XKS-0505](#) [XGS-2405](#) [XGS-1215](#) [XGS-0515](#) [PS9Z-6RM4](#) [73-551-5038I](#) [AK1601-9RT](#) [VI-R5022-EXWW](#) [PSC128-](#)
[7iR](#) [RPS8-350ATX-XE](#) [DAS1004812](#) [VI-LJ11-iz](#) [PQA30-D24-S24-DH](#) [VI-M5F-CQ](#) [VI-LN2-EW](#) [VI-PJW01-CZY](#) [CK2540-9ERT](#)