

M12 female 90° A-cod. IDC

4-pol., 0.25 - 0.5mm², 4 - 5,1mm

Female 90°

M12, 4-pole

IDC terminals

Connection cross section: 0.25...0.5 mm²

Art-No. 7005 - M12 Lite - (plastic hexagonal screw) on request

The resistance to aggressive media should be individually tested for your application. Further details on request.

[Link to Product](#)

Illustration

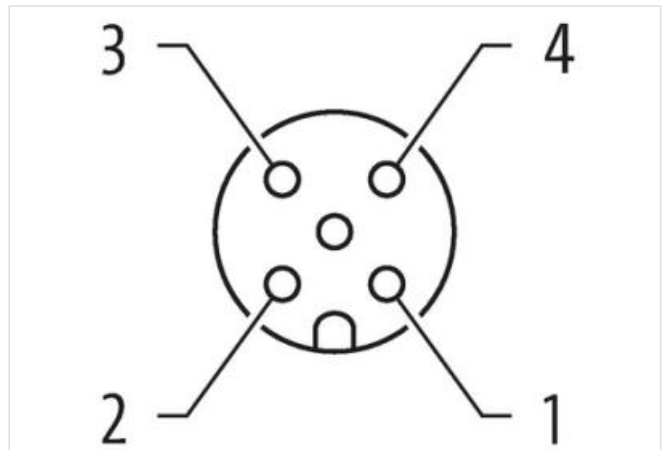
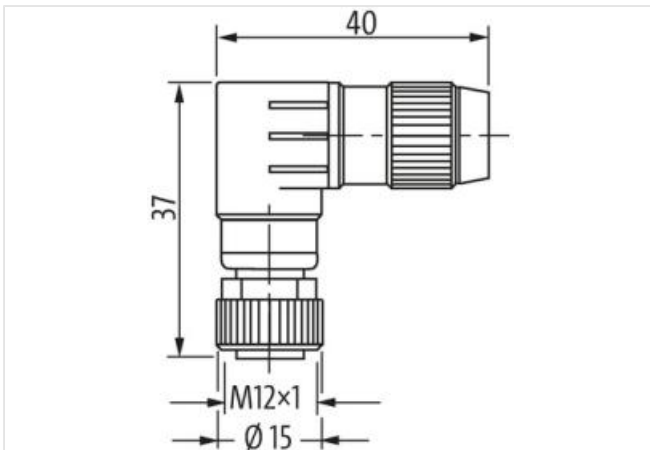
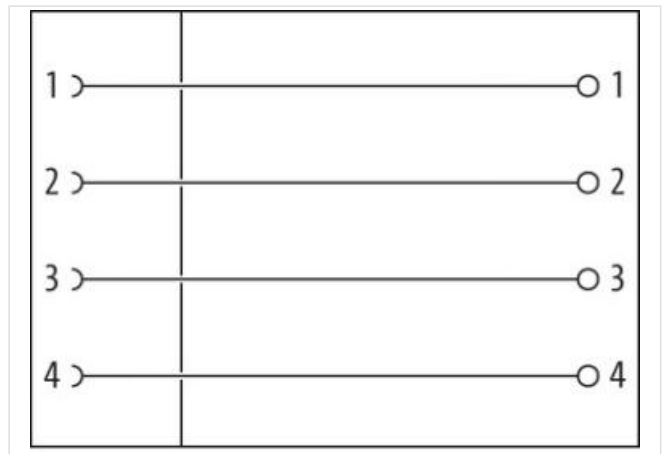

Product may differ from Image

Side 1

Family construction form	M12
Degree of protection (EN IEC 60529)	IP67

Commercial data

ECLASS-6.0	27279221
ECLASS-6.1	27260702
ECLASS-7.0	27440102
ECLASS-8.0	27440102
ECLASS-9.0	27440116

ECLASS-10.1	27440102
ECLASS-11.1	27440102
ECLASS-12.0	27440116
ETIM-5.0	EC002635
customs tariff number	85366990
GTIN	4048879201681
Packaging unit	1

Electrical data | Supply

Operating voltage AC max.	32 V
Operating voltage DC max.	32 V
Current operating per contact max.	4 A

Installation

Connection cross section min.	0,25 mm ²
Connection cross section max.	0,5 mm ²
Single wire diameter min.	0,1 mm

Installation | Connection

Wire insulation diameter min.	1,2 mm
Wire insulation diameter max.	1,6 mm
Tightening torque	0,6 Nm

Device protection | Electrical

Additional condition protection degree	inserted, screwed
--	-------------------

Mechanical data | Mounting data

Mounting method	inserted, screwed, Shaking protection
Clamping range min.	4 mm
Clamping range max.	5,1 mm
Height	37 mm
Width	40 mm
Depth	15 mm

Environmental characteristics | Climatic

Operating temperature min.	-25 °C
Operating temperature max.	85 °C

Important installation notes

Note on strain relief	Protect the connectors by suitable measures from mechanical loads, e.g. by the usage of cable ties.
Note on bending radius	Attention: Observe the permissible bending radii when laying cables, as the IP protection class can be endangered by excessive bending forces.

X-ON Electronics

Largest Supplier of Electrical and Electronic Components

Click to view similar products for [Circular DIN Connectors](#) category:

Click to view products by [Murr Elektronik](#) manufacturer:

Other Similar products are found below :

[D38999/20MJ37PB](#) [75-190222-09G](#) [FRCIR030FP-36-10P-F80](#) [FRCIR08F-18-19S-F80](#) [FRCIR08R-36-7S-F80](#) [8R3006A18M0033](#) [PT05A-14-18SW\(023\)](#) [PT05A-14-5SX](#) [GTC01A-22-28P](#) [PT05A1832SW](#) [PT05A2041SX](#) [PT05SE1832SWLC](#) [PT05SE1832SYLC](#)
[GTC030-20-27PW-LC](#) [ACC06AF-20-23P\(003\)](#) [1210500311](#) [1210503216](#) [ACS00F-16-10S\(003\)](#) [ACS06AF-16-10P\(003\)](#) [D38999/42FE35AN](#)
[D38999/46WE6SN](#) [MS3100F22-23S](#) [MS3100R36-5S](#) [MS3101E28-21S](#) [MS3101E2821SX](#) [MS3102E184PW](#) [MS310314S-5P](#) [MS310314S-6P](#) [MS310314S-7P](#) [MS310322-8S](#) [MS3114F10-6P](#) [MS3116E8-4SW](#) [MS3122E10-6PW](#) [MS3456W28-21PZ-LC](#) [C18213N21](#) [CA3100E14S-9PB](#) [CA3100E14SA7P](#) [CA3100E16-10S](#) [CA3100E16S-8PBF80](#) [CA3100E18-1SBF80A176](#) [CA3100E20-7SB-F80-A176](#) [CA3100E22-14SB](#)
[CA3100E22-14SBF80](#) [CA3100E22-19PBF80](#) [CA3100E22-22SB](#) [CA3100E22-22SBF80](#) [CA3100E22-2SBF80](#) [CA3100E22-7PB](#)
[CA3100E28-21PWB02](#) [CA3100E32-15PB](#)