

MSUD valve plug A-18mm with cable

PVC 3x0.75 ye 5m

MSUD

Form A (18 mm)

24 V AC $\pm 20\%$ / DC $\pm 25\%$

LED and suppression

Bridged PE

Further cable lengths on request.

Plastic housings with good resistance against chemicals and oils.

The resistance to aggressive media should be individually tested for your application. Further details on request.

[Link to Product](#)

Illustration

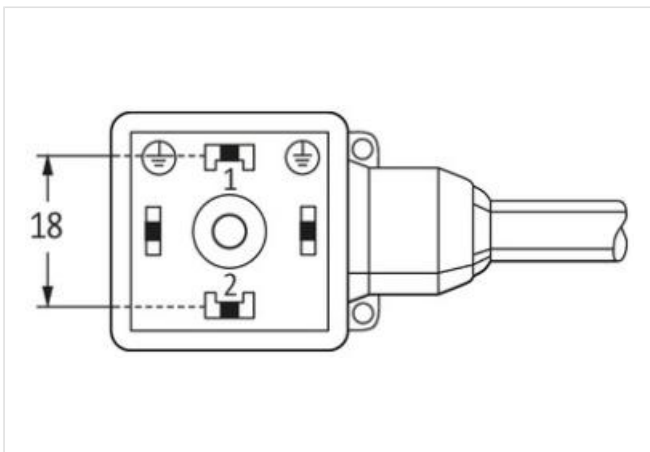
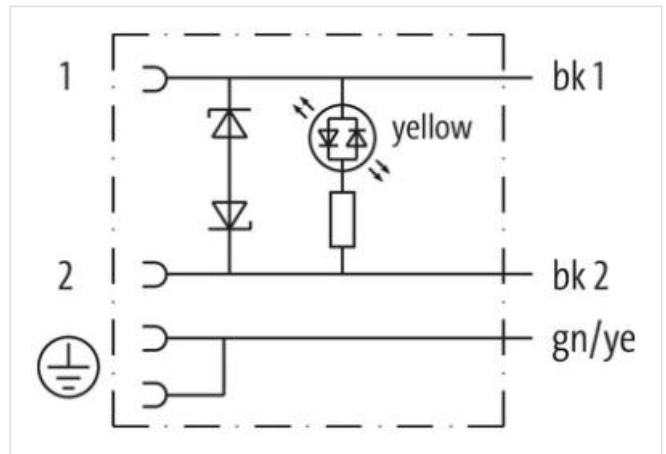

Product may differ from Image

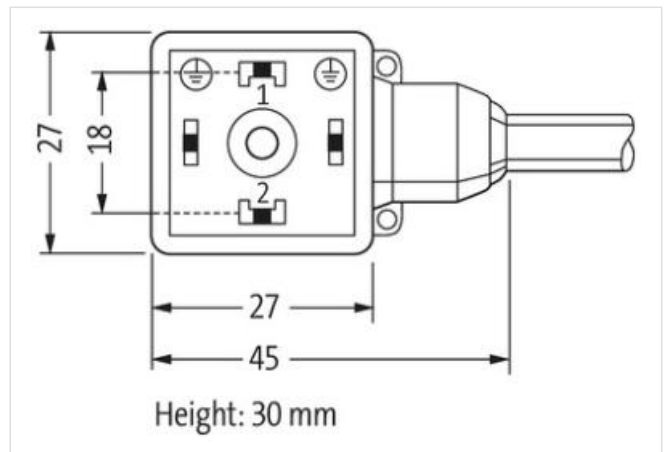

Cable length 5 m

classifications

ECLASS-6.0	27279218
ECLASS-7.0	27279218
ECLASS-8.0	27279218
ECLASS-9.0	27060311
ECLASS-10.1	27060312
ECLASS-11.1	27060312
ECLASS-12.0	27060312
ETIM-5.0	EC001855

Technical Data

Operating voltage	24 V AC $\pm 20\%$ / DC $\pm 25\%$
Rated surge voltage	0.8 kV
Operating current per contact	max. 4 A
Current consumption	max. 15 mA
Material group	IEC 60664-1, category I
Switch off peak	max. 55 V
LED display	yellow
Locking of ports	M3 (recommended torque 0.4 Nm)
Protection	IP67 inserted and tightened (EN 60529)
Material	PBT
Locking material	Steel (galvanized)
Housing	Black plastic (gray on request)
Additional suppressor	Diode/Z-Diode
Switch off delay time	max. 20 ms

General data

Material gasket	PUR
Pollution Degree	3
Temperature range	-25...+85 °C, depending on cable quality

Cable

Cable identification	016
Cable Type	1 (PVC)
Approval (cable)	CE conform
Cable weight [g/m]	63,8 g
Material wire	Cu wire, bare
Resistor (core)	max. 26 Ω /km (20 °C)
Single wire \varnothing (core)	0.2 mm
Construction (core)	24x 0.2 mm (multi-strand wire class 5)
Diameter (core)	3x 0.75 mm ²
AWG	similar to AWG 18
Material wire isolation	PVC
Material property wire insulation	CFC-, cadmium-, silicone- and lead-free
Shore hardness wire isolation	43 ± 5 D
Wire- \varnothing incl. isolation	1.8 mm $\pm 5\%$
Color/numbering of wires	bk numbered, gnye longitudinally striped
Stranding combination	3 wires twisted
Shield	no
Material jacket	PVC
Material property (jacket)	CFC-, cadmium-, silicone- and lead-free
Shore hardness jacket	80 ± 5 A
Outer- \varnothing (jacket)	5.9 mm $\pm 5\%$
Color jacket	yellow
chemical resistance	good resistance to oil, gasoline and chemicals
Nominal voltage	300/500 V AC
Test voltage	3000 V AC

Current load capacity	to DIN VDE 0298-4
Temperature range (fixed)	-30...+70 °C
Temperature range (mobile)	-5...+70 °C
Bend radius (fixed)	5× outer Ø
Bend radius (moving)	10× outer Ø

Commercial data

customs tariff number	85444290
GTIN	4048879194563
Packaging unit	1

X-ON Electronics

Largest Supplier of Electrical and Electronic Components

Click to view similar products for [Sensor Cables / Actuator Cables](#) category:

Click to view products by [Murr Elektronik](#) manufacturer:

Other Similar products are found below :

[60963](#) [60964](#) [M83513/19-F01CP](#) [703000D02F2002](#) [703000D02F300](#) [703001D02F0602](#) [703001D02F1201](#) [703001D02F300](#)
[773032K02F030](#) [802027213811-1](#) [804001A09M150](#) [805001A09M0502](#) [84914-0235](#) [84914-0237](#) [885030A09M010](#) [8R4006A18M010](#)
[8R4J30E03C3003](#) [1200650503](#) [1200651713](#) [1200660844](#) [1200660845](#) [1200661173](#) [1200680071](#) [1200720053](#) [1200720081](#) [1200720099](#)
[1200720217](#) [1200800231](#) [1200860125](#) [1200870123](#) [1200660183](#) [1200660782](#) [1200660849](#) [1200661295](#) [1200661297](#) [1200661342](#)
[1200661343](#) [1200670080](#) [1200680331](#) [1200720252](#) [1200720255](#) [1200720597](#) [1200730184](#) [1200860344](#) [1200870359](#) [1200870643](#)
[1200980008](#) [1200980031](#) [1210502211](#) [1210400542](#)