

**M12 male 0° / M12 female 90° A-cod.**

PVC 4x0.34 ye UL/CSA 1.5m

Male straight – female 90°

M12 – M12, 4-pole

Art-No. 7005 - M12 Lite - (plastic hexagonal screw) on request

Plastic housings with good resistance against chemicals and oils.

The resistance to aggressive media should be individually tested for your application. Further details on request.

Further cable lengths on request.

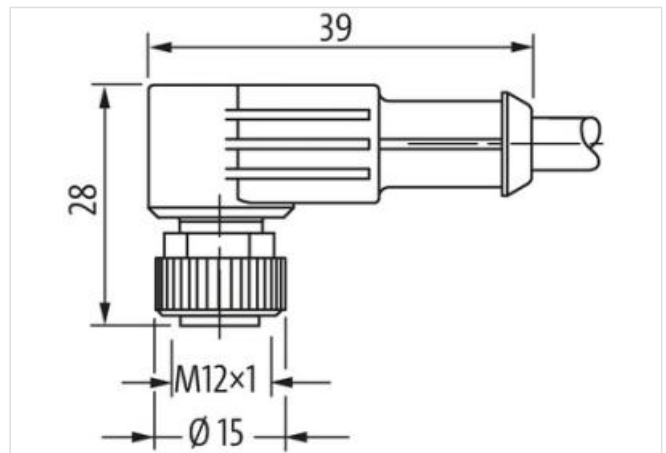
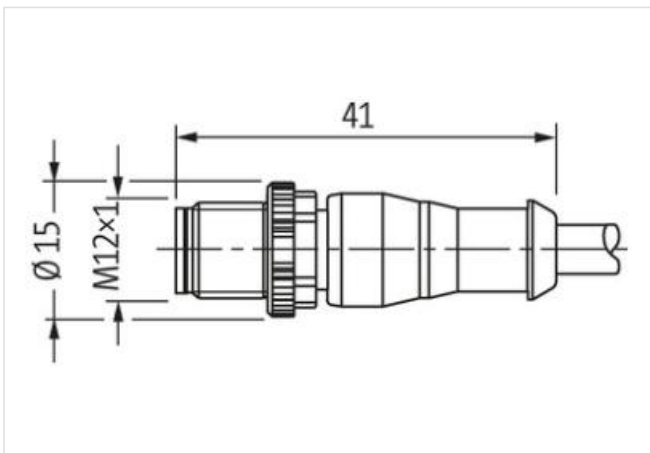
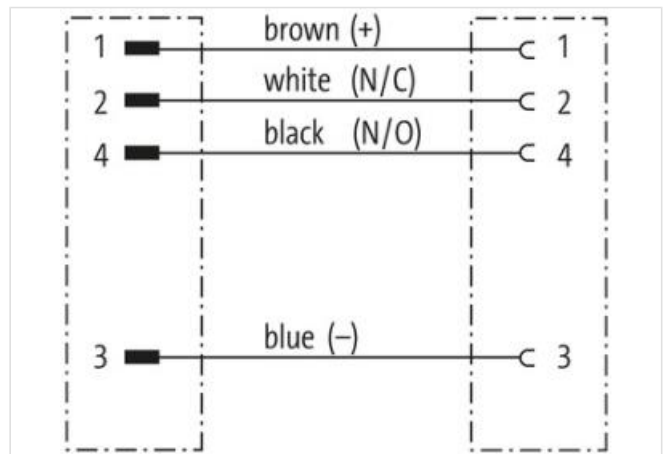
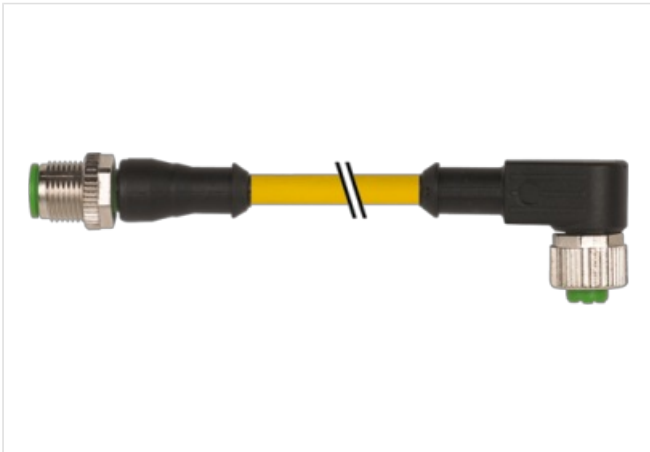
[Link to Product](#)**Illustration**

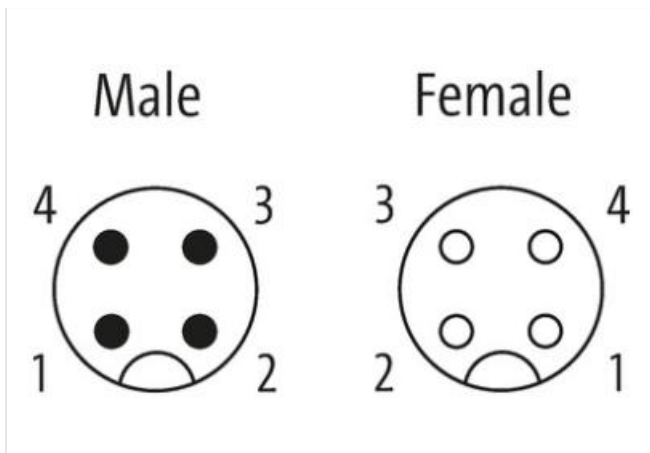

Product may differ from Image



Cable length 1,5 m

**classifications**

ECLASS-6.0	27279218
ECLASS-7.0	27279218
ECLASS-8.0	27279218
ECLASS-9.0	27060311
ECLASS-10.1	27060311
ECLASS-11.1	27060311
ECLASS-12.0	27060311
ETIM-5.0	EC001855

**Technical Data**

Operating voltage	max. 250 V AC/DC
Operating voltage (only UL listed)	30 V AC/DC
Operating current per contact	max. 4 A
Material group	IEC 60664-1, category I
Locking of ports	Screw thread (M12×1 mm) recommended torque 0.6 Nm, self-securing
Protection	IP65, IP66K, IP67 inserted and tightened (EN 60529)
Material	PUR
Locking material	Zinc die casting, matte nickel plated
suitable for corrugated tube (internal Ø)	10 mm
Compression gland	M12 (SW13)

**General data**

Standards	DIN EN 61076-2-101 (M12)
Pollution Degree	3
Temperature range	-25...+85 °C, depending on cable quality

**Cable**

Cable identification	014
Cable Type	1 (PVC)
Approval (cable)	UL (AWM-Style 2464/1731), CSA
Cable weight [g/m]	40,7 g
Material wire	Cu wire, bare

Resistor (core)	max. 60 $\Omega$ /km (20 °C)
Single wire $\varnothing$ (core)	0.15 mm
Construction (core)	19× 0.15 mm (multi-strand wire class 5)
Diameter (core)	4× 0.34 mm <sup>2</sup>
AWG	similar to AWG 22
Material wire isolation	PVC
Material property wire insulation	CFC-, cadmium-, silicone- and lead-free
Shore hardness wire isolation	45 ±5 D
Wire- $\varnothing$ incl. isolation	1.25 mm ±5%
Color/numbering of wires	br, bk, bl, wh
Stranding combination	4 wires twisted
Shield	no
Material jacket	PVC
Material property (jacket)	CFC-, cadmium-, silicone- and lead-free
Shore hardness jacket	85 ±5 A
Outer- $\varnothing$ (jacket)	5.0 mm ±5%
Color jacket	yellow
chemical resistance	good resistance to oil, gasoline and chemicals
thermal resistance	flame retardant UL 1581 VW1 / CSA FT1
Nominal voltage	UL 300 V AC
Test voltage	2000 V AC
Current load capacity	to DIN VDE 0298-4
Temperature range (fixed)	-30...+80 °C
Temperature range (mobile)	-5...+80 °C
Bend radius (fixed)	5× outer $\varnothing$
Bend radius (moving)	10× outer $\varnothing$
<b>Commercial data</b>	
customs tariff number	85444290
GTIN	4048879178785
Packaging unit	1

## X-ON Electronics

Largest Supplier of Electrical and Electronic Components

*Click to view similar products for [Sensor Cables / Actuator Cables](#) category:*

*Click to view products by [Murr Elektronik](#) manufacturer:*

Other Similar products are found below :

[60963](#) [60964](#) [M83513/19-F01CP](#) [703000D02F2002](#) [703000D02F300](#) [703001D02F0602](#) [703001D02F1201](#) [703001D02F300](#)  
[773032K02F030](#) [802027213811-1](#) [804001A09M150](#) [805001A09M0502](#) [84914-0235](#) [84914-0237](#) [885030A09M010](#) [8R4006A18M010](#)  
[8R4J30E03C3003](#) [1200650503](#) [1200651713](#) [1200660844](#) [1200660845](#) [1200661173](#) [1200680071](#) [1200720053](#) [1200720081](#) [1200720099](#)  
[1200720217](#) [1200800231](#) [1200860125](#) [1200870123](#) [1200660183](#) [1200660782](#) [1200660849](#) [1200661295](#) [1200661297](#) [1200661342](#)  
[1200661343](#) [1200670080](#) [1200680331](#) [1200720252](#) [1200720255](#) [1200720597](#) [1200730184](#) [1200860344](#) [1200870359](#) [1200870643](#)  
[1200980008](#) [1200980031](#) [1210502211](#) [1210400542](#)