

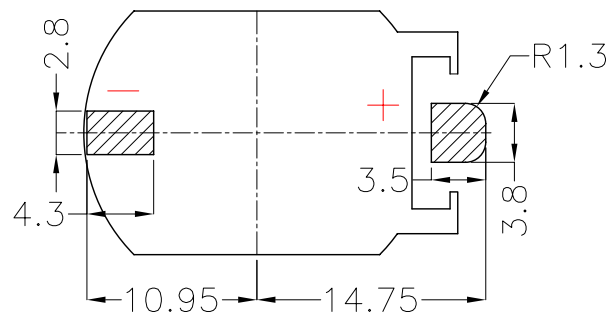

REV.	ECN NO.	REVISED	DATE

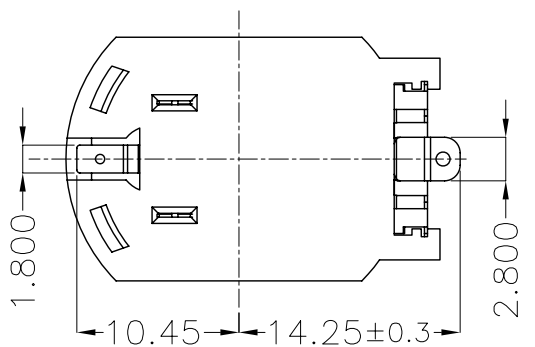
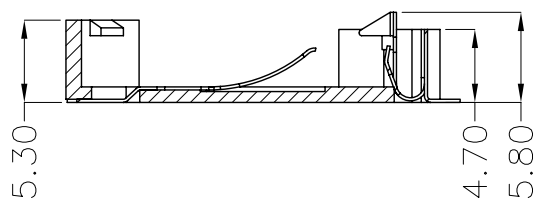
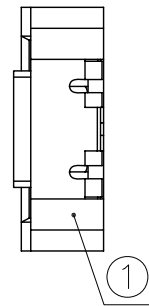
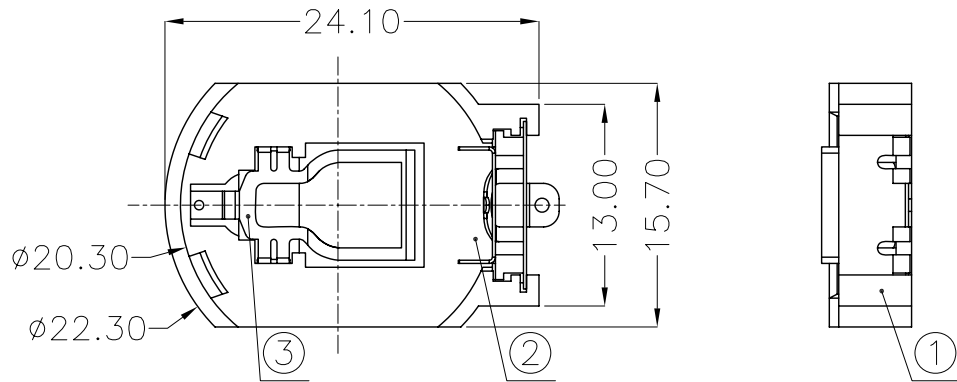

PCB Layout Diagram
Top View

NOTE:

1.MATERIAL:

- a.HOUSING:PPA
- b.CONTACT:PHOSPHOR BRONZE
(SURFACE PLATING: Au1U")

SEE ORDERING INFORMATION

2.ELECTRIC:

- a.CONTACT RESISTANCE: 30 MILLIOHMS MAX
- b.INSULATION RESISTANCE: 1000 MEGA OHMS MIN
- c.DIELECTNIC VOLTAGE: 500V AC ONE SEC LEVEL
- d.OPERATING TEMPERATURE: -25°C~ +85°C

ORDERING INFORMATION

BS-08-B***008

电池座系列

BS-08系列

SMT 180° TYPE

- A-Au1U"
- J-Ni100U"~120U"
- K-Sn100U"~120U"
- L-Ni150U"- Sn80U"

- MATERIAL:
- 1A-PBT BLACK
 - 1B-PA66 BLACK
 - 2A-PPA BROWN
 - 2B-PPA BLACK
 - 3A-PPS BROWN
 - 3B-PPS BLACK
 - 4A-LCP WHITE
 - 4B-LCP BLACK



UNLESS OTHERWISE SPECIFIED TOLERANCES		MYOUNG 美阳 www.meiyangdz.com	
DECIMALS: X :±0.30 X.X :±0.25 X.XX :±0.20 X.XXX :±0.10	ANGLES: X :±1° X.X :±0.5°	DSND YangFeng	DATE 2017-06-30
		CHKD ZhouRuicai	DATE 2017-06-30
		APVD XueShunyong	DATE 2017-06-30
WEIGHT: 0.92g		SCALE: 2:1	SIZE: A4
SHEET 1 OF 1		VIEW:	REV.: A/0
		UNIT: mm	OBJECT: MY
		TITLE: BS-2032-8KG SMT	
		PART NO.: BS-08-B2AA008	
		DRAW NO.:MY-CP-0077	

3	TERMINAL(-)	1	PHOSPHOR BRONZE, T=0.20mm	Gold Plating and Ni Under-Plating
2	TERMINAL(+)	1	PHOSPHOR BRONZE, T=0.25mm	Gold Plating and Ni Under-Plating
1	HOUSING	1	PPA	BROWN
NO.	PART NAME	Q'TY	MATERIAL	PLATING & COLOR

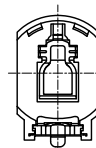

产品

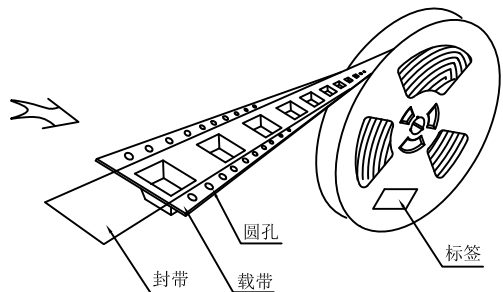

圆孔

封带

载带

标签

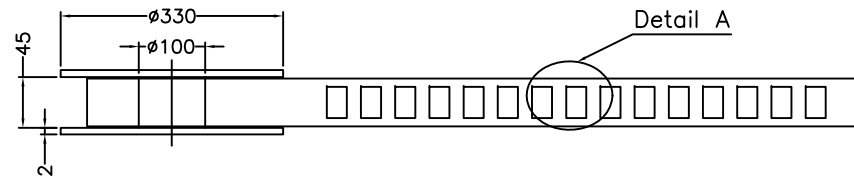

Detail A

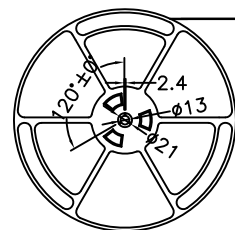

出料方向

余留封带长: 300 MIN
载带与封带剥离
剥离角度: 165°-180°
剥离强度: 0.1-1.0N
(300mm/min)

剥离方向

10空穴 共封装 500 只产品 300MIN 15空穴
末端留空穴载带 前端留空穴载带

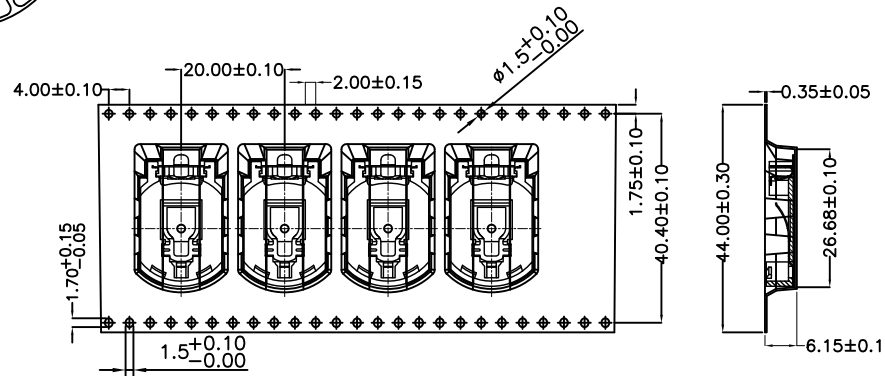
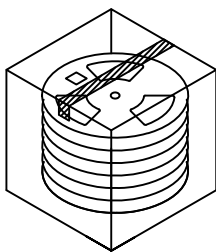
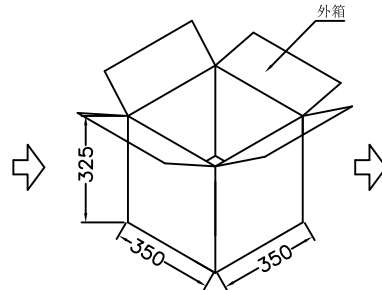
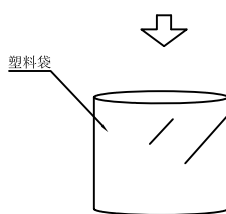
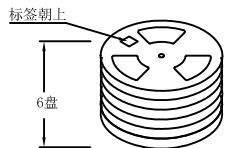

Detail A



- 技术要求:
1. 圆孔十个孔距离累计允许公差为±0.2mm
 2. 带长250mm内容许弯曲度1mm
 3. 材料厚度以在载带边缘测量为准
 4. 所有尺寸定义依循EIA-481-C系准则定义之
 5. 材料: 黑色PS T=0.35mm
 6. 所有卷轮为灰蓝挖空旋转塑胶卷轮
 7. 整模成型长度:10.5M,
 8. 非指明公差范围为: ±0.1mm; 超过250mm不计算累计误差
 9. 型腔外形凡未标明处倒角R为0.2-0.3; 拔模斜度未标注的为3:1以下

- 包装信息:
- 1、每卷盘装产品 500 只, 卷盘外侧贴相关标签;
 - 2、每 6 卷盘放在一个塑料袋中;
 - 3、每外箱装6盘, 产品总数: 3000 只;
 - 4、外箱上下用胶纸封成“工”字;
 - 5、净重: 3.5 KG, 毛重: 6.5 KG.

UNLESS OTHERWISE SPECIFIED TOLERANCES		MYOUNG 美阳 www.meiyangdz.com			
DECIMALS: X : ±*** X.X : ±*** X.XX : ±*** X.XXX : ±***	ANGLES: X : ±*** X.X : ±***	DSND	YangFeng	DATE	2020-08-19
WEIGHT:		CHKD	ZhouRuicai	DATE	2020-08-19
SHEET 1 OF 1		APVD	XueShunyong	DATE	2020-08-19
		SCALE:	3:1	SIZE:	A4
		UNIT:	mm	REV.:	A/0
		VIEW:	④ ⊞	OBJECT:	MY
		TITLE:		BS-2032-8 SMT 卷装	
		PART NO.:		BS-08-B***00*-R	
		DRAW NO.:		MY-BD-0007	

X-ON Electronics

Largest Supplier of Electrical and Electronic Components

Click to view similar products for [Coin Cell Battery Holders](#) category:

Click to view products by [MYOUNG](#) manufacturer:

Other Similar products are found below :

[9-1066-GF](#) [SMTU2450N-LF](#) [PDSN-11-D](#) [799-2007](#) [BH44AAB](#) [BH48DL](#) [BH8000](#) [MY-2430-01-R](#) [BS-16-B4AA006-R](#) [BS-24-B4AA016-R](#)
[BS-08-B2AA025-R](#) [101](#) [3035](#) [1025](#) [1027](#) [103](#) [1060](#) [1063](#) [1065](#) [D3](#) [46400000](#) [BC-0403](#) [BH-121-1B](#) [BH-1/2AA-2A](#) [BH-131A](#) [BH-3101A](#)
[BH-3103B](#) [BH-311-1A](#) [BH-311-1D](#) [BH-321-1A](#) [BH-321-1B](#) [BH-321-1D](#) [BH-331-3D](#) [BH-331P](#) [BH-333A](#) [BH-341-1P](#) [BH-342-1A](#) [BH-](#)
[351A](#) [BH-383A](#) [BH-422A](#) [BH-425A](#) [BH-431-1B](#) [BH-463A](#) [BH-511A](#) [46300000](#) [799-2001](#) [SBH-331A](#) [SBH-341-1A](#) [SBH-341-AS](#) [SBH-](#)
[431-1AS](#)