



REV.	ECN NO.	REVISED	DATE

NOTE:

1.MATERIAL:

- a.HOUSING:PPA
- b.CONTACT:PHOSPHOR BRONZE
(SURFACE PLATING: Au1u")

SEE ORDERING INFORMATION

2.ELECTRIC:

- a.CONTACT RESISTANCE: 30 MILLIOHMS MAX
- b.INSULATION RESISTANCE: 1000 MEGA OHMS MIN
- c.DIELECTNIC VOLTAGE: 500V AC ONE SEC LEVEL
- d.OPERATING TEMPERATURE: -25° C~ +85° C

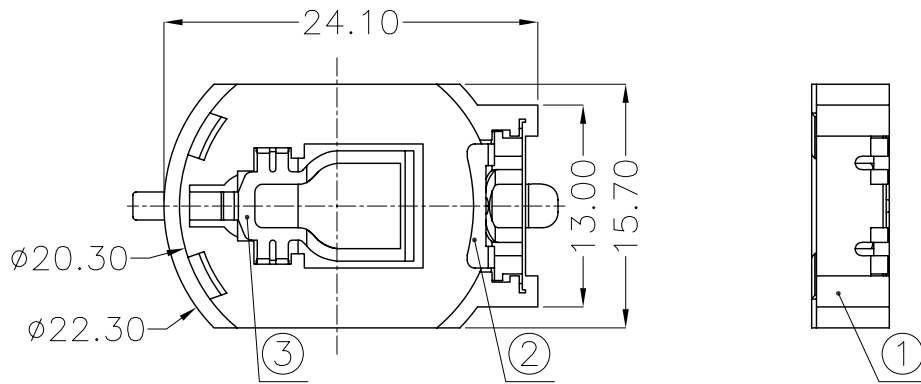

ORDERING INFORMATION

BS-08-B*004**

电池座系列

BS-08系列

SMT 180° TYPE

PLATING:
A-Au1U"
J-Ni100U"~120U"
K-Sn100U"~120U"

MATERIAL:
1A-PBT BLACK
1B-PA66 BLACK
2A-PPA BROWN
2B-PPA BLACK
3A-PPS BROWN
3B-PPS BLACK
4A-LCP WHITE
4B-LCP BLACK



PCB Layout Diagram
Top View

UNLESS OTHERWISE SPECIFIED TOLERANCES		MYOUNG 美阳 www.meiyangdz.com	
DECIMALS: X :±0.30 X.X :±0.25 X.XX :±0.20 X.XXX :±0.10	ANGLES: X :±1° X.X :±0.5°	DSND YangFeng	DATE 2017-06-29
WEIGHT: 0.78g		CHKD ZhouRuicai	DATE 2017-06-29
SHEET 1 OF 1		APVD XueShunyong	DATE 2017-06-29
UNIT: mm		SCALE: 2:1	VIEW:
REV.: A/0		SIZE: A4	OBJECT: MY
DRAW NO.:MY-CP-0062		TITLE: BS-2032-8C 5MM SMT PART NO.: BS-08-B2BA004	

NO.	PART NAME	Q'TY	MATERIAL	PLATING & COLOR
3	TERMINAL(-)	1	PHOSPHOR BRONZE, T=0.20mm	Gold Plating and Ni Under-Plating
2	TERMINAL(+)	1	PHOSPHOR BRONZE, T=0.20mm	Gold Plating and Ni Under-Plating
1	HOUSING	1	PPA	BLACK



产品

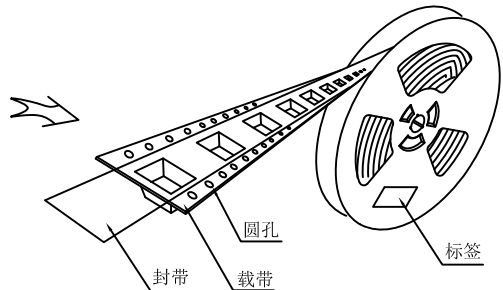

圆孔

封带

载带

标签

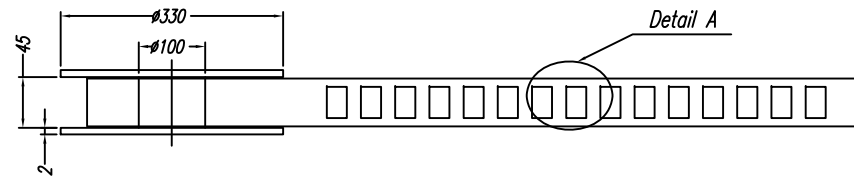

Detail A

出料方向

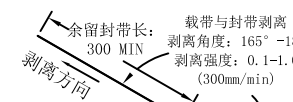

剥离方向

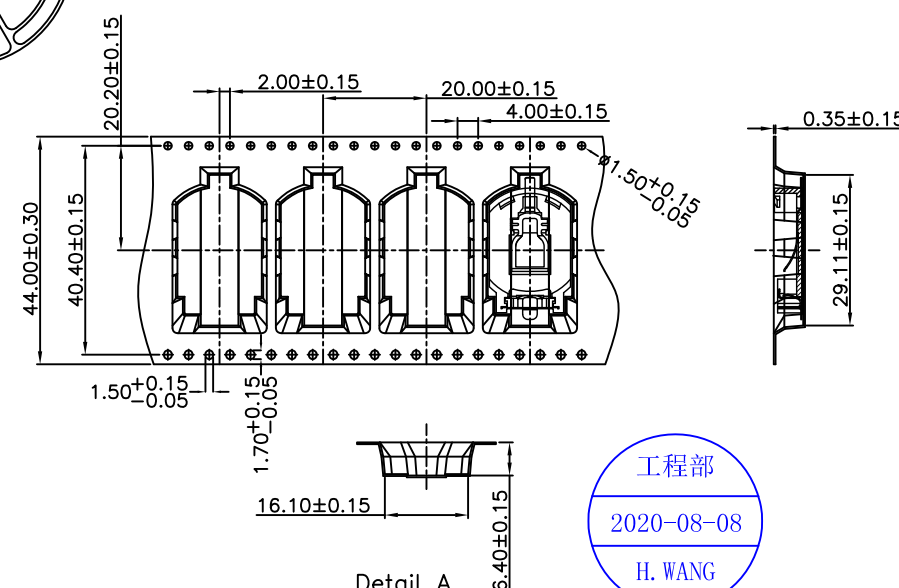
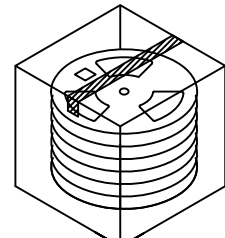
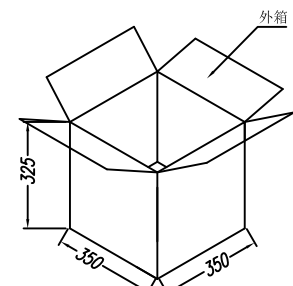
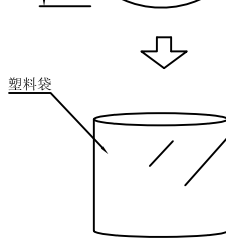
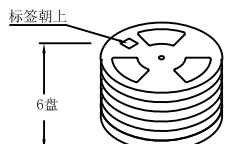
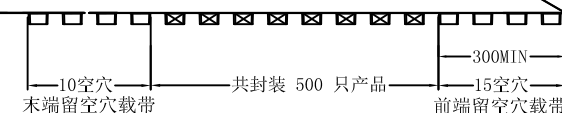
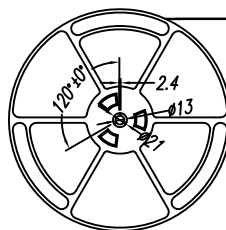

Detail A



技术要求:

1. 圆孔十个孔距离累计允许公差为 $\pm 0.2\text{mm}$
2. 带长250mm内容许弯曲度1mm
3. 材料厚度以在载带边缘测量为准
4. 所有尺寸定义依循EIA-481-C系准则定义之
5. 材料: 黑色PS T=0.35mm
6. 所有卷轮为灰蓝挖空旋转塑胶卷轮
7. 整模成型长度:10.5M,
8. 非指明公差范围为: $\pm 0.1\text{mm}$; 超过250mm不计算累计误差
9. 型腔外形凡未标明处倒角R为0.2-0.3; 拔模斜度未标注的为 $3^\circ 00'IA$

包装信息:

- 1、每卷盘装产品 500 只, 卷盘外侧贴相关标签;
- 2、每 6 卷盘放在一个塑料袋中;
- 3、每外箱装6盘, 产品总数: 3000 只;
- 4、外箱上下用胶纸封成“工”字;
- 5、净重: 3.5 KG, 毛重: 6.5 KG.

UNLESS OTHERWISE SPECIFIED TOLERANCES		MYOUNG 美阳 www.meiyangdz.com	
DECIMALS: X : ±*** X.X : ±*** X.XX : ±*** X.XXX : ±***	ANGLES: X : ±*** X.X : ±***	DSND YangFeng	DATE 2020-08-08
WEIGHT:		CHKD ZhouRuicai	DATE 2020-08-08
SHEET 1 OF 1		APVD XueShun Yong	DATE 2020-08-08
		SCALE: 3:1	VIEW:
		UNIT: mm	REV.: A/0
		OBJECT: MY	TITLE: BS-2032-8C SMT 卷装
			PART NO.: BS-08-B***00*-R
			DRAW NO.: MY-BD-0036

X-ON Electronics

Largest Supplier of Electrical and Electronic Components

Click to view similar products for [Coin Cell Battery Holders](#) category:

Click to view products by [MYOUNG](#) manufacturer:

Other Similar products are found below :

[9-1066-GF](#) [SMTU2450N-LF](#) [PDSN-11-D](#) [799-2007](#) [BH44AAB](#) [BH48DL](#) [BH8000](#) [MY-2430-01-R](#) [BS-16-B4AA006-R](#) [BS-24-B4AA016-R](#)
[BS-08-B2AA025-R](#) [101](#) [3035](#) [1025](#) [1027](#) [103](#) [1060](#) [1063](#) [1065](#) [D3](#) [46400000](#) [BC-0403](#) [BH-121-1B](#) [BH-1/2AA-2A](#) [BH-131A](#) [BH-3101A](#)
[BH-3103B](#) [BH-311-1A](#) [BH-311-1D](#) [BH-321-1B](#) [BH-321-1D](#) [BH-331-3D](#) [BH-331P](#) [BH-333A](#) [BH-341-1P](#) [BH-342-1A](#) [BH-351A](#) [BH-](#)
[383A](#) [BH-422A](#) [BH-425A](#) [BH-431-1B](#) [BH-463A](#) [BH-511A](#) [46300000](#) [799-2001](#) [SBH-331A](#) [SBH-341-1A](#) [SBH-341-AS](#) [SBH-431-1AS](#)
[SBH-441A](#)