

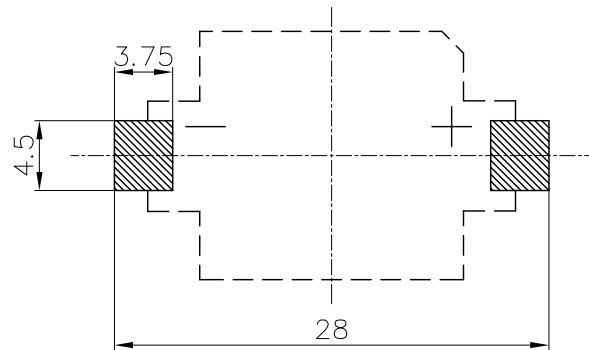

REV.	ECN NO.	REVISED	DATE
A/1	MY20200401001	LQ.HUANG	2020.04.01

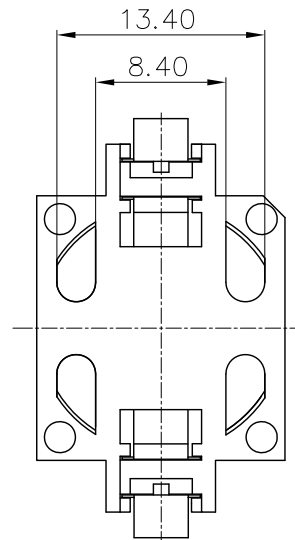
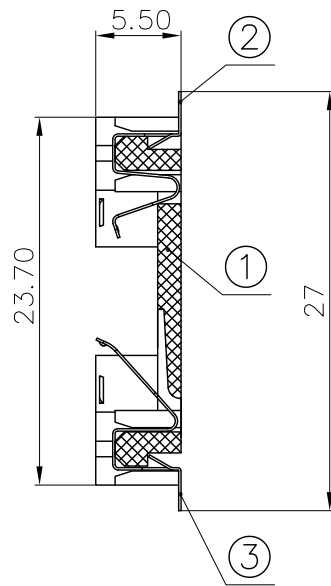
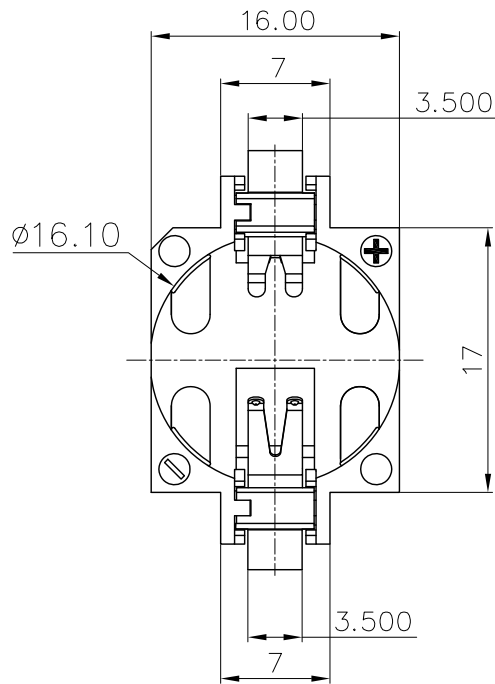

PCB Layout Diagram  
Top View

NOTE:

- MATERIAL:
  - HOUSING:LCP
  - CONTACT:PHOSPHOR BRONZE  
(SURFACE PLATING: Sn100U~120U)  
SEE ORDERING INFORMATION
- ELECTRIC:
  - CONTACT RESISTANCE: 30 MILLIOHMS MAX
  - INSULATION RESISTANCE: 100 MEGA OHMS MIN
  - DIELECTNIC VOLTAGE: 500V AC ONE SEC LEVEL
  - OPERATING TEMPERATURE: -40°C~ +85°C

ORDERING INFORMATION

BS-16-B\*\*\*003

电池座系列

BS-16系列

SMT 180° TYPE

PLATING:  
A-Au1U"  
J-Ni100U"~120U"  
K-Sn100U"~120U"

MATERIAL:  
1A-PBT BLACK  
1B-PA66 BLACK  
2A-PPA BROWN  
2B-PPA BLACK  
3A-PPS BROWN  
3B-PPS BLACK  
4A-LCP WHITE  
4B-LCP BLACK



3	TERMINAL(-)	1	PHOSPHOR BRONZE, T=0.15mm	Sn-Plating
2	TERMINAL(+)	1	PHOSPHOR BRONZE, T=0.15mm	Sn-Plating
1	HOUSING	1	LCP	WHITE
NO.	PART NAME	Q'TY	MATERIAL	PLATING & COLOR

UNLESS OTHERWISE SPECIFIED TOLERANCES		<b>MYOUNG 美阳</b> <a href="http://www.meiyangdz.com">www.meiyangdz.com</a>	
DECIMALS: X :±0.30 X.X :±0.25 X.XX :±0.20 X.XXX :±0.10	ANGLES: X :±1° X.X :±0.5°	DSND YangFeng	DATE 2020-04-01
WEIGHT: 1.34g		CHKD ZhouRuicai	DATE 2020-04-01
SHEET 1 OF 1		APVD XueShunyong	DATE 2020-04-01
SCALE: 2:1	SIZE: A4	VIEW:	TITLE: BS-1632-1 SMT
UNIT: mm	REV.: A/1	OBJECT: MY	PART NO.: BS-16-B4AK003
			DRAW NO.:MY-CP-0085

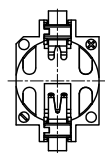

产品

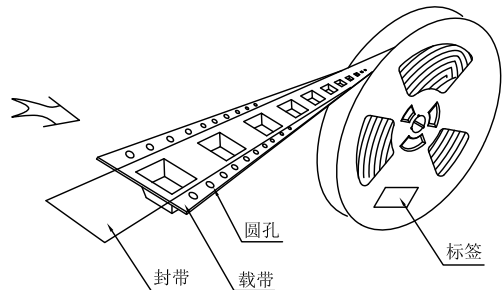

圆孔

封带

载带

标签

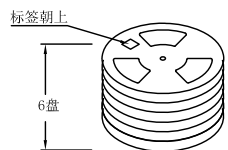

标签朝上

6盘

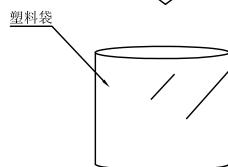

塑料袋

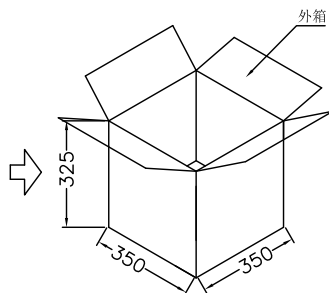

外箱

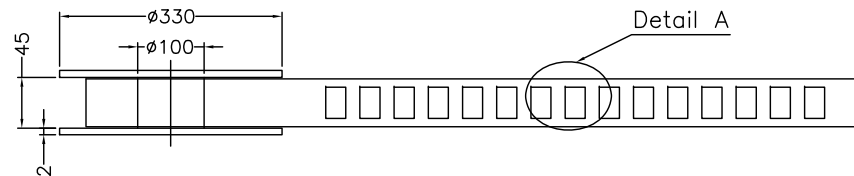
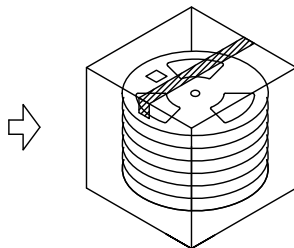

Detail A

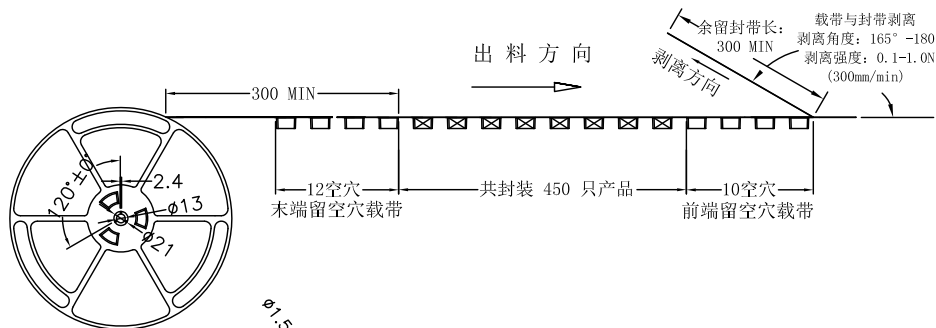

出料方向

剥离方向

余留封带长: 300 MIN  
载带与封带剥离角度: 165° -180°  
剥离强度: 0.1-1.0N (300mm/min)

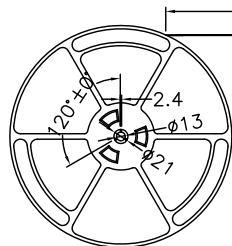

φ1.50±0.10

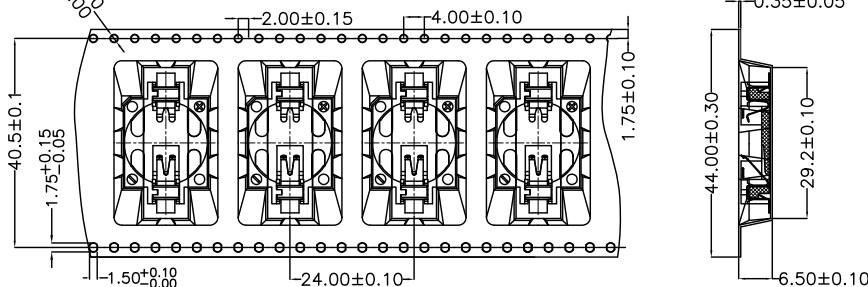

Detail A



技术要求:

1. 圆孔十个孔距离累计允许公差为±0.2mm
2. 带长250mm内容许弯曲度1mm
3. 材料厚度以在载带边缘测量为准
4. 所有尺寸定义依循EIA-481-C系准则定义之
5. 材料: 黑色PS T=0.35mm
6. 所有卷轮为灰蓝挖空旋转塑胶卷轮
7. 整模成型长度: 11.328M,
8. 非指明公差范围为: ±0.1mm; 超过250mm不计算累计误差
9. 型腔外形凡未标明处倒角R为0.2-0.3; 拔模斜度未标注的为3° 以下

包装信息:

- 1、每卷盘装产品 450 只, 卷盘外侧贴相关标签;
- 2、每 6 卷盘放在一个塑料袋中;
- 3、每外箱装6盘, 产品总数: 2700 只;
- 4、外箱上下用胶纸封成“工”字;
- 5、净重: 3.42 KG, 毛重: 5.6 KG。

UNLESS OTHERWISE SPECIFIED TOLERANCES		<b>MYOUNG 美阳</b> www.meiyangdz.com			
DECIMALS: X : ±*** X.X : ±*** X.XX : ±*** X.XXX : ±***	ANGLES: X : ±*** X.X : ±***	DSND	YangFeng	DATE	2017-12-01
		CHKD	ZhouRuicai	DATE	2017-12-01
		APVD	XueShunyong	DATE	2017-12-01
WEIGHT:		SCALE:	3:1	SIZE:	A4
SHEET 1 OF 1		UNIT:	mm	REV.:	A/0
		VIEW:	④ ⊞	OBJECT:	MY
		TITLE:		BS-1632-1 SMT 卷装	
		PART NO.:		BS-16-B***00*-R	
		DRAW NO.:		MY-BD-0012	

## X-ON Electronics

Largest Supplier of Electrical and Electronic Components

*Click to view similar products for [Coin Cell Battery Holders](#) category:*

*Click to view products by [MYOUNG](#) manufacturer:*

Other Similar products are found below :

[9-1066-GF](#) [SMTU2450N-LF](#) [PDSN-11-D](#) [799-2007](#) [BH44AAB](#) [BH48DL](#) [BH8000](#) [MY-2430-01-R](#) [BS-16-B4AA006-R](#) [BS-24-B4AA016-R](#)  
[BS-08-B2AA025-R](#) [101](#) [3035](#) [1025](#) [1027](#) [103](#) [1060](#) [1063](#) [1065](#) [D3](#) [46400000](#) [BC-0403](#) [BH-121-1B](#) [BH-1/2AA-2A](#) [BH-131A](#) [BH-3101A](#)  
[BH-3103B](#) [BH-311-1A](#) [BH-311-1D](#) [BH-321-1A](#) [BH-321-1B](#) [BH-321-1D](#) [BH-331-3D](#) [BH-331P](#) [BH-333A](#) [BH-341-1P](#) [BH-342-1A](#) [BH-](#)  
[351A](#) [BH-383A](#) [BH-422A](#) [BH-425A](#) [BH-431-1B](#) [BH-463A](#) [BH-511A](#) [46300000](#) [799-2001](#) [SBH-331A](#) [SBH-341-1A](#) [SBH-341-AS](#) [SBH-](#)  
[431-1AS](#)