

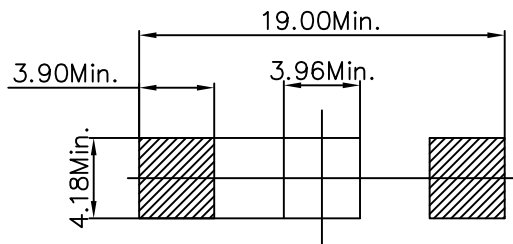

REV.	ECN NO.	REVISED	DATE

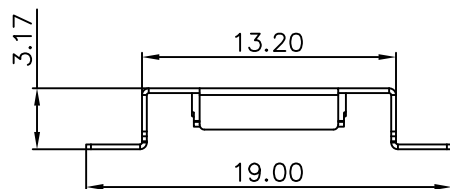
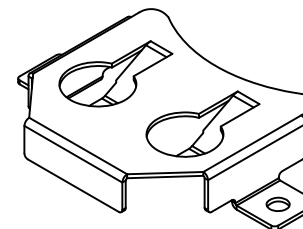
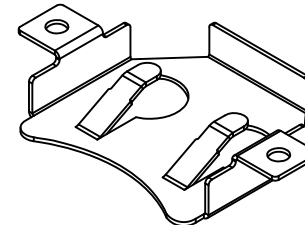
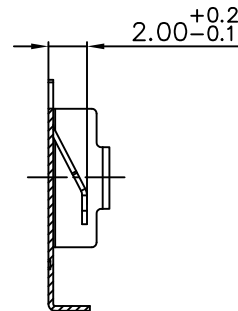
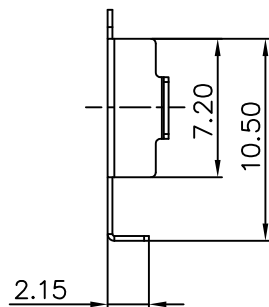
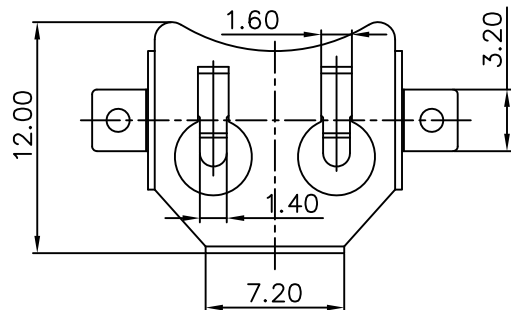

PCB Layout Diagram  
Top View

工程部  
2019-05-06  
LQ. HUANG

技术要求:

- 1、截剪断面毛刺高度 $\leq 0.03\text{mm}$ ;
- 2、部件要求平整,无变形、裂纹、损伤等外观缺陷;

UNLESS OTHERWISE SPECIFIED TOLERANCES		<b>MYOUNG 美阳</b> <a href="http://www.meiyangdz.com">www.meiyangdz.com</a>			
DECIMALS: X :±0.30 X.X :±0.25 X.XX :±0.20 X.XXX :±0.10	ANGLES: X :±1° X.X :±0.5°	DSND	YangFeng	DATE	2019-05-06
		CHKD	ZhouRuicai	DATE	2019-05-06
		APVD	XueShunyong	DATE	2019-05-06
WEIGHT: g		SCALE:	SIZE: A4	VIEW:	
SHEET 1 OF 1		UNIT: mm	REV.: A/1	OBJECT: MY	TITLE: 电池扣CR1220-W SMT
		PART NO.:		MY-1220-03	
		DRAW NO.:MY-CP-0210			

1	TERMINAL(+)	1	PHOSPHOR BRONZE, T=0.20mm	Ni-Plating
NO.	PART NAME	Q'TY	MATERIAL	PLATING & COLOR

## X-ON Electronics

Largest Supplier of Electrical and Electronic Components

*Click to view similar products for [Coin Cell Battery Holders](#) category:*

*Click to view products by [MYOUNG](#) manufacturer:*

Other Similar products are found below :

[9-1066-GF](#) [SMTU2450N-LF](#) [PDSN-11-D](#) [799-2007](#) [BH44AAB](#) [BH48DL](#) [BH8000](#) [MY-2430-01-R](#) [BS-16-B4AA006-R](#) [BS-24-B4AA016-R](#)  
[BS-08-B2AA025-R](#) [101](#) [3035](#) [1025](#) [1027](#) [103](#) [1060](#) [1065](#) [D3](#) [46400000](#) [BC-0403](#) [BH-121-1B](#) [BH-1/2AA-2A](#) [BH-131A](#) [BH-3101A](#) [BH-3103B](#) [BH-311-1A](#) [BH-311-1D](#) [BH-321-1A](#) [BH-321-1B](#) [BH-321-1D](#) [BH-331-3D](#) [BH-331P](#) [BH-333A](#) [BH-341-1P](#) [BH-342-1A](#) [BH-351A](#)  
[BH-383A](#) [BH-422A](#) [BH-425A](#) [BH-431-1B](#) [BH-463A](#) [BH-511A](#) [46300000](#) [799-2001](#) [SBH-331A](#) [SBH-341-1A](#) [SBH-341-AS](#) [SBH-431-1AS](#) [SBH-441A](#)