

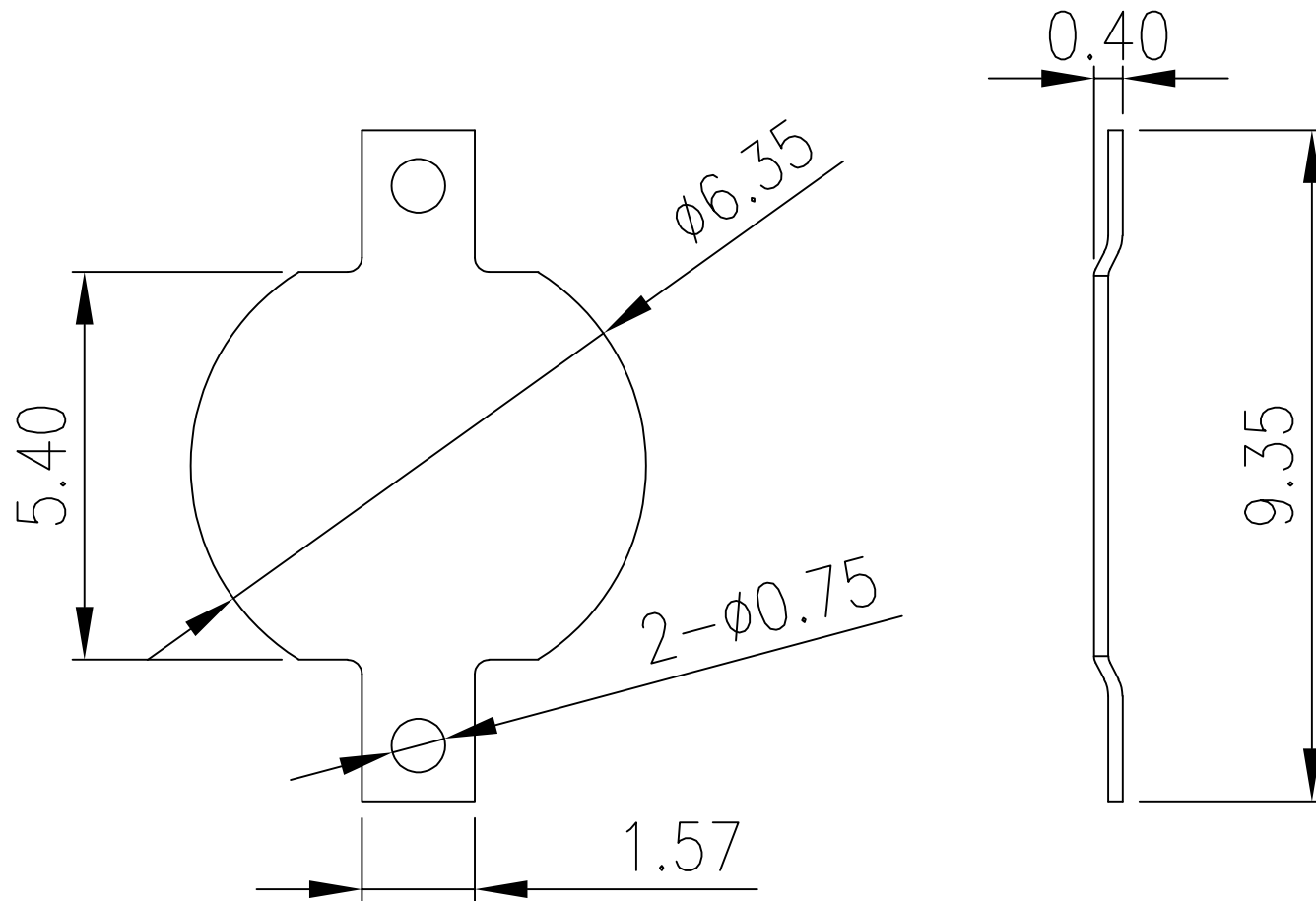

REV.	ECN NO.	REVISED	DATE



UNLESS OTHERWISE SPECIFIED TOLERANCES		<b>MYOUNG 美用</b> <a href="http://www.meiyangdz.com">www.meiyangdz.com</a>			
DECIMALS: X :±0.30 X.X :±0.25 X.XX :±0.20 X.XXX :±0.10	ANGLES: X :±1° X.X :±0.5°	DSND	YangFeng	DATE	2023-07-13
WEIGHT:		CHKD	ZhouRuicai	DATE	2023-07-13
SHEET 1 OF 2		APVD	XueShunyong	DATE	2023-07-13
		SCALE:	SIZE: A4	VIEW:	
		UNIT: mm	REV.: A/0	OBJECT: MY	
		TITLE:		钮扣电池通用负极片01 镀镍 卷装	
		PART NO.:		MY-FJ-04-J-R	
		DRAW NO.:		WD-CP-0269	

1	TERMINAL(-)	1	BRASS, T=0.2MM	Ni-Plating
NO.	PART NAME	Q'TY	MATERIAL	PLATING & COLOR



产品

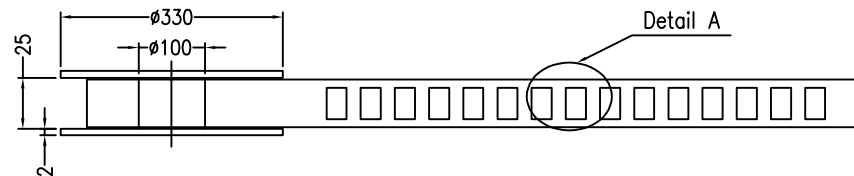
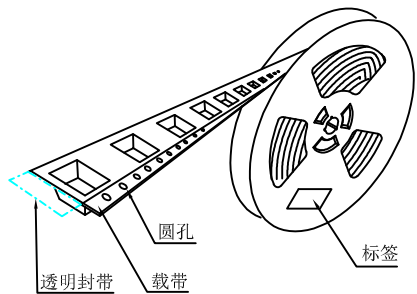

Detail A

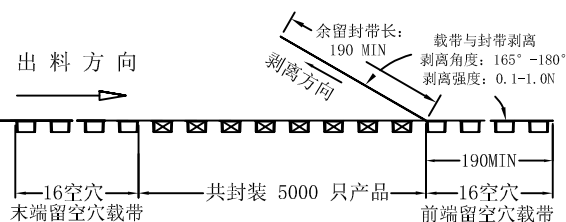

出料方向

剥离方向

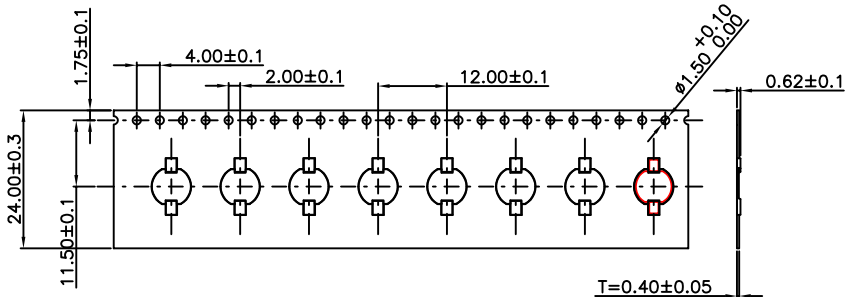
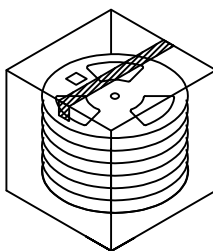
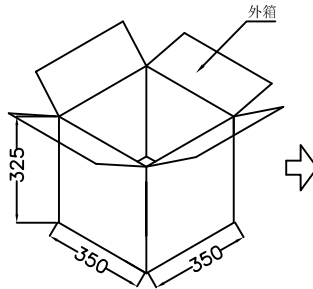
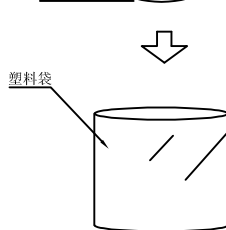
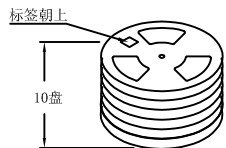
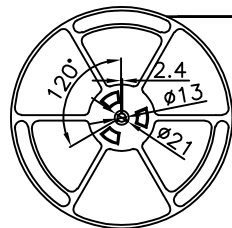

Detail A



技术要求:

1. 圆孔十个孔距距离累计允许公差为 $\pm 0.2\text{mm}$
2. 带长250mm内容许弯曲度1mm
3. 材料厚度以在载带边缘测量为准
4. 所有尺寸定义依循EIA-481-C系准则定义之
5. 材料: 黑色PS T=0.4mm
6. 所有卷轮为灰蓝挖空旋转塑胶卷轮
7. 整模成型长度: 60.384M,
8. 非指明公差范围为:  $\pm 0.1\text{mm}$ ; 超过250mm不计算累计误差
9. 型腔外形凡未标明处倒角R为0.2-0.3; 拔模斜度未标注的为 $3^\circ$  以下

包装信息:

1. 每卷盘装产品 5000 只, 卷盘外侧贴相关标签;
2. 每 10 卷盘放在一个塑料袋中;
3. 每外箱装10盘, 产品总数: 50000 只;
4. 外箱上下用胶纸封成“工”字;
5. 电池座包材纽扣电池通用负极片01 卷装 (MY-FJ-04-R)

UNLESS OTHERWISE SPECIFIED TOLERANCES		<b>MYOUNG 美阳</b> www.meiyangdz.com	
DECIMALS: X : ±*** X.X : ±*** X.XX : ±*** X.XXX : ±***	ANGLES: X : ±*** X.X : ±***	DSND YangFeng	DATE 2023-07-13
		CHKD ZhouRuicai	DATE 2023-07-13
		APVD XueShun Yong	DATE 2023-07-13
WEIGHT:		SCALE:	VIEW:
SHEET 2 OF 2		UNIT: mm	REV.: A/0
		SIZE: A4	OBJECT: MY
		TITLE: 纽扣电池通用负极片01 镀镍 卷装	
		PART NO.: MY-FJ-04-J-R	
		DRAW NO.:MY-BD-0073	

## X-ON Electronics

Largest Supplier of Electrical and Electronic Components

*Click to view similar products for [Coin Cell Battery Holders](#) category:*

*Click to view products by [MYOUNG](#) manufacturer:*

Other Similar products are found below :

[PDSN-11-D](#) [799-2007](#) [BH44AAB](#) [BH48DL](#) [BH8000](#) [MY-2430-01-R](#) [BS-16-B4AA006-R](#) [KH-CR1220-2](#) [BH-18650-A1AJ006](#) [BS-02-A1BK007](#) [BH-18650-A1AJ005](#) [BS-12-B3AA009-R](#) [BS-02-A1AK010-X](#) [BS-02-A1AJ010](#) [BS-03-A1AJ001](#) [MY-FJ-131-J-R](#) [MY-FJ-04-J-R](#) [BS-08-B2AA025](#) [BS-24-A1AJ017](#) [BH-18650-A5BJ001-2D](#) [BS-12-A1AJ002-Z](#) [BS-08-B2AA032](#) [MY-2032-04-R](#) [BS-12-B3AA011-R](#) [BS-621-B4AA001-R](#) [MY-ZJ-110](#) [MY-FJ-127-R](#) [BS-06-B4AA002-R](#) [MY-1220-04](#) [BH-AAA-A1AJ001](#) [BS-12-B3AA003-T](#) [MY-FJ-115II-R](#) [BS-06-B4AK001-R](#) [BH-18650-B1BA007](#) [MY-FJ-115II](#) [BH-AAA-B5AA001](#) [BE-13-017](#) [MY-2477-01](#) [BS-12-B3AA013](#) [BC-25-5PD-300](#) [BS-08-B2AA016-R](#) [MY-AAA-22-J](#) [MY-AA-14-J](#) [MY-AAA-24-J](#) [MY-2032-28](#) [BS-06-A4BK016](#) [MY-FJ-01](#) [MY-1025-01](#) [MY-AA-5355-J](#) [BS-05-A1BJ018](#)