

产品

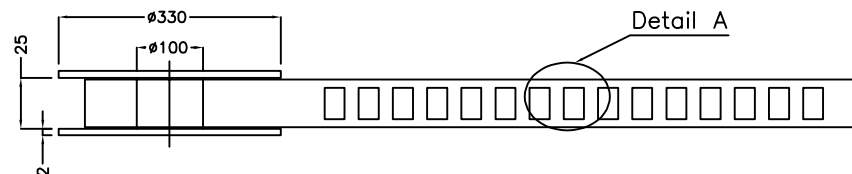

Detail A

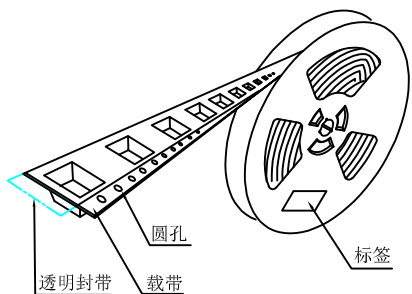
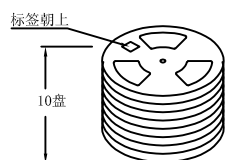
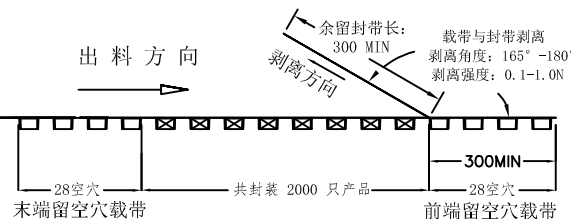
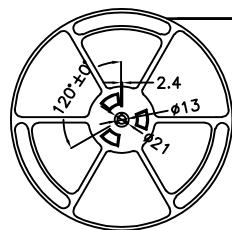

10盘

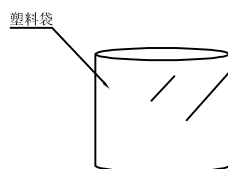

塑料袋

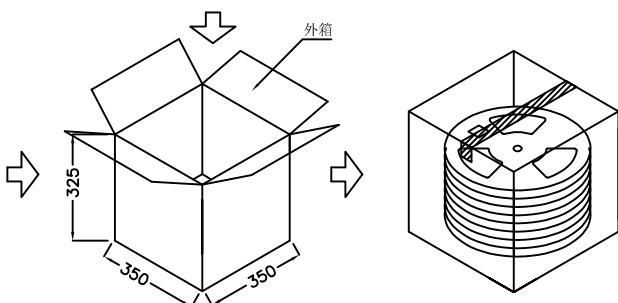

外箱

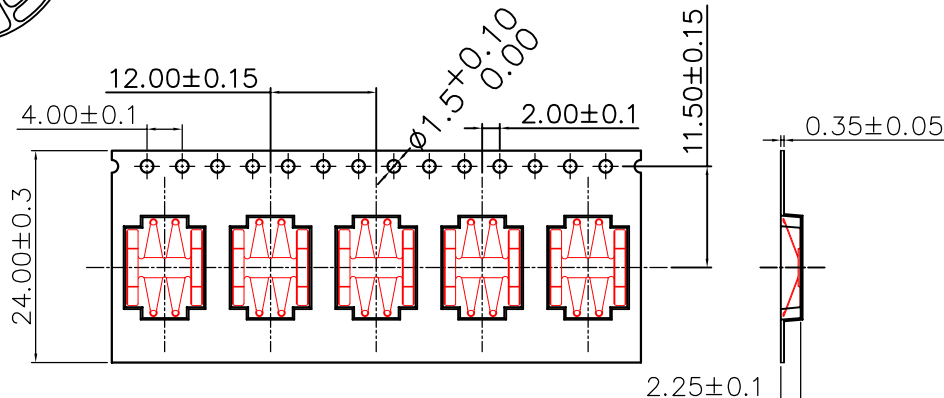

工程部

2023-02-02

H. WANG

Detail A

技术要求:

1. 圆孔十个孔距离累计允许公差为±0.2mm
2. 带长250mm内容许弯曲度1mm
3. 材料厚度以在载带边缘测量为准
4. 所有尺寸定义依循EIA-481-C系准则定义之
5. 材料:透明PS T=0.35±0.05mm
6. 所有卷轮为灰蓝挖空旋转塑胶卷轮
7. 整模成型长度:24.672M,
8. 非指明公差范围为: ±0.1mm;超过250mm不计算累计误差
9. 型腔外形凡未标明处倒角R为0.2-0.3; 拔模斜度未标注的为3° 以下

包装信息:

- 1、每卷盘装产品 2000 只, 卷盘外侧贴相关标签;
- 2、每 10 卷盘放在一个塑料袋中;
- 3、每外箱装10盘, 产品总数: 20000 只;
- 4、外箱上下用胶纸封成“工”字;

UNLESS OTHERWISE SPECIFIED TOLERANCES		MYOUNG 美阳 www.meiyangdz.com			
DECIMALS: X : ±*** X.X : ±*** X.XX : ±*** X.XXX : ±***	ANGLES: X : ±*** X.X : ±***	DSND	YangFeng	DATE	2023-02-02
		CHKD	ZhouRuicai	DATE	2023-02-02
		APVD	XueShun Yong	DATE	2023-02-02
WEIGHT:		SCALE:	1:1	SIZE:	A4
SHEET 1 OF 1		VIEW:	④	REV.:	A/0
		UNIT:	mm	OBJECT:	MY
		TITLE:		八角电池弹片负极-127 SMT 卷装	
		PART NO.:		MY-FJ-127-R	
		DRAW NO.:		MY-BD-0064	

X-ON Electronics

Largest Supplier of Electrical and Electronic Components

Click to view similar products for [Coin Cell Battery Holders](#) category:

Click to view products by [MYOUNG](#) manufacturer:

Other Similar products are found below :

[PDSN-11-D](#) [799-2007](#) [BH44AAB](#) [BH48DL](#) [BH8000](#) [MY-2430-01-R](#) [BS-16-B4AA006-R](#) [KH-CR1220-2](#) [BH-18650-A1AJ006](#) [BS-02-A1BK007](#) [BH-18650-A1AJ005](#) [BS-12-B3AA009-R](#) [BS-02-A1AK010-X](#) [BS-02-A1AJ010](#) [BS-03-A1AJ001](#) [MY-FJ-131-J-R](#) [MY-FJ-04-J-R](#) [BS-08-B2AA025](#) [BS-24-A1AJ017](#) [BH-18650-A5BJ001-2D](#) [BS-12-A1AJ002-Z](#) [BS-08-B2AA032](#) [MY-2032-04-R](#) [BS-12-B3AA011-R](#) [BS-621-B4AA001-R](#) [MY-ZJ-110](#) [MY-FJ-127-R](#) [BS-06-B4AA002-R](#) [MY-1220-04](#) [BH-AAA-A1AJ001](#) [BS-12-B3AA003-T](#) [MY-FJ-115II-R](#) [BS-06-B4AK001-R](#) [BH-18650-B1BA007](#) [MY-FJ-115II](#) [BH-AAA-B5AA001](#) [BE-13-017](#) [MY-2477-01](#) [BS-12-B3AA013](#) [BC-25-5PD-300](#) [BS-08-B2AA016-R](#) [MY-AAA-22-J](#) [MY-AA-14-J](#) [MY-AAA-24-J](#) [MY-2032-28](#) [BS-06-A4BK016](#) [MY-FJ-01](#) [MY-1025-01](#) [MY-AA-5355-J](#) [BS-05-A1BJ018](#)