

Power Supplies



MYRRA

...Of course !

Encapsulated Solutions
1W ~ 60W

Myrra company Profile

Myrra Transformers, Inductors, Chokes and Power Supplies are World renowned for their reliability and performance. This is the result of constant technological development and continuous production process improvements, which has made Myrra Group a leading Company in both design (R&D) and manufacturing.

With their own range of products, including encapsulated Power Supplies, Transformers (50/60Hz), HF Transformers and Value-Added Services, Myrra has become a reliable and renowned Global Supplier.

Since incorporation in 1949, Myrra has become one of the largest European sources for their products in the electrical market, and is striving to grow their position in a continuously evolving market.

As a Company certified by VDE, UL, CSA, ISO9001 and with a clear policy for conservation of the environment (RoHs, REACH, ISO14001), Myrra is an ideal partner for your future requirements.

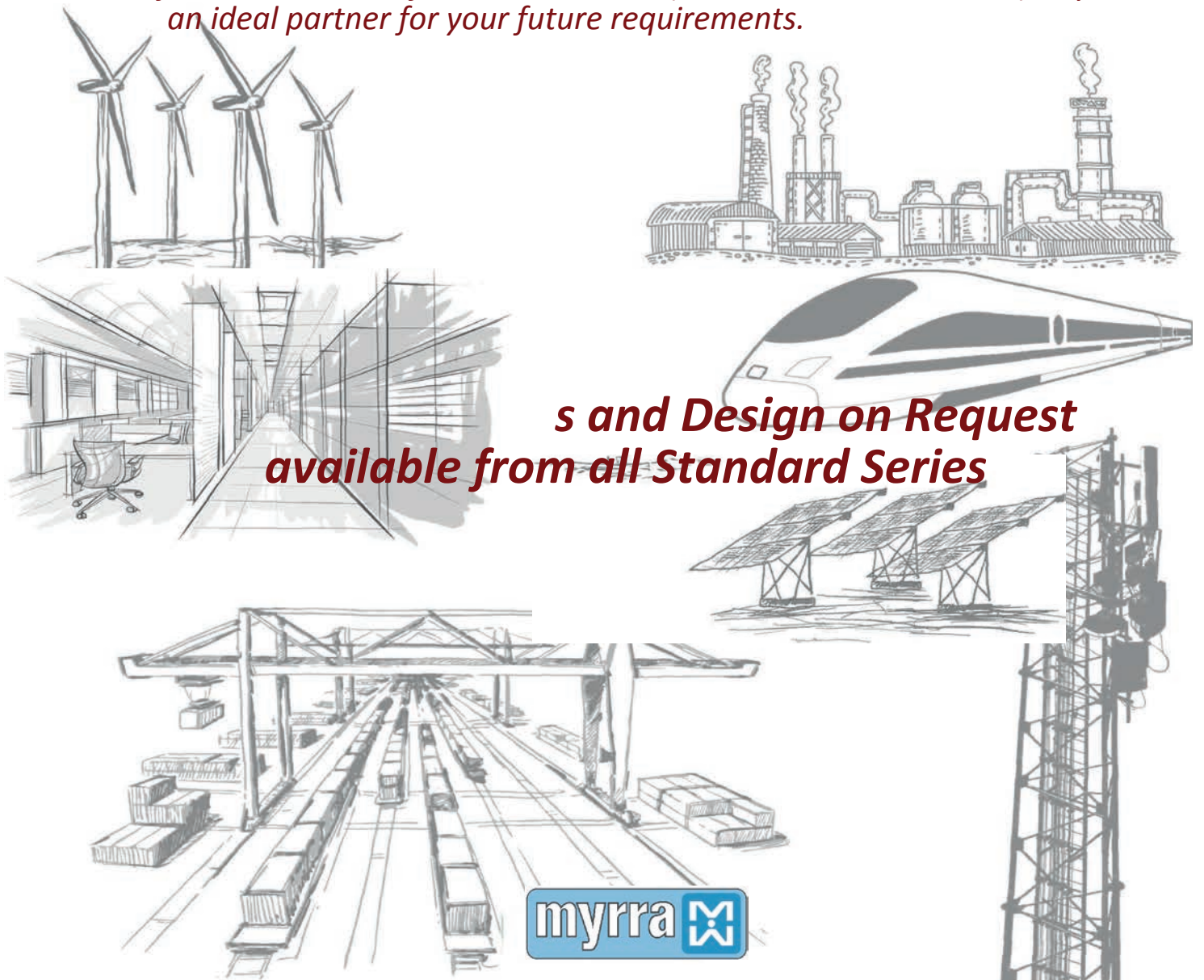

**s and Design on Request
available from all Standard Series**



Encapsulated Power Supplies

*"We at Myrra, Design and Manufacture
all our Power Products,
ensuring our Customers experience
consistent Quality and Reliability"*

Catalogue Contents

Page	Details
2-3	Products overview
48000 Series	
4	Single Output 1W ~3W
47000 Series	
6	Single Output 2.5W ~ 5W
8	Single Output 2.4W ~ 5W (relaxed regulation)
10	Dual Output 3W ~ 5W (common ground)
12	Dual Output 3W ~ 4W (isolated outputs)
14	Single Output 7.5W
16	Single Output 10W
18	Single Output 20W
20	Single Output 30W ~ 40W
22	Single Output 40W ~ 60W
Support and Service	
24	Application notes 47000 and 48000 series
25	Modified and Custom Solutions





1W to 3W

3 Certified Power Ratings
in
1 Power Supply



2.5W to 5W



7.5W



10W



20W to 60W



POWER SUPPLIES 1W to 60W

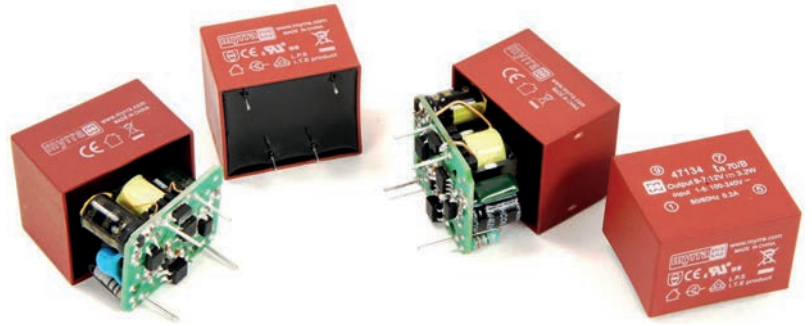

Series 47/48000

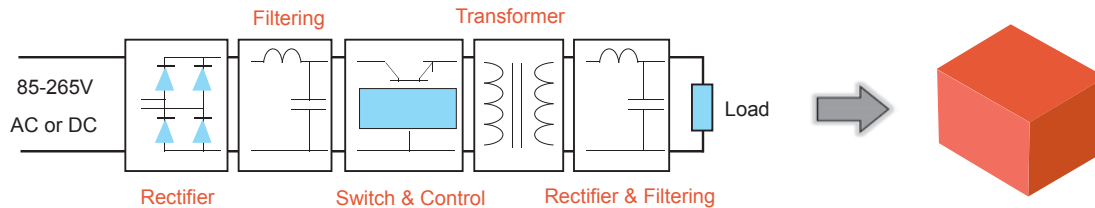

MYRRA encapsulated Switched Mode Power Supplies is based on Flyback topology.

They constitute an interesting alternative to the traditional supply in the most common applications of power from 1W to 60W.

ENERGY SAVING due to high efficiency and low standby power.

Application for our Power Supplies:

- Alternative to the linear transformers in all AC/DC applications of power up to 60W
- Alternative to DC/DC converters for application in D.C. current (Telecom supplies, electric substations etc.)
- Industrial, domestic and consumer electronics applications
- Standby devices and others DC or AC auxiliary supplies

With the same footprint as an EI30 transformer, they will replace:

- 50 Hz Transformer
- Fuse
- Bridge Rectifier
- Filtering Capacitor

Regulated types will also replace linear regulator and heatsink

MAIN FEATURES

- **Wide input voltage range**
- **Increased power: 3 x compared to standard EE20-EI30-EI38 transformers**
- **Better energetic efficiency: 70% typical compared to 40% for the conventional supply**
- **Very low Standby Power consumption: meets requirements of Energy Star or EC Code of Conduct**
- **Same footprint as EE20-EI30-EI38-EI48 transformer: (1W~10W) Upgrade your application without redesign of PCB**

SAFETY STANDARDS

Meets all requirements of:

- EN 60950
- EN 60335
- EN 61558-2-16
- EN 61558-1
- UL 60950-1
- CSA 22.2 N°60950-1
- UL 94-V0

EMC STANDARDS

Conducted and radiated emissions conform to

- EN 55014-1
- EN 55032 class B

Immunity conform to

- EN 55014-2
- EN 61000-4-x

ONE OUTPUT 1W to 3W - Small Compact Size



MAIN FEATURES :

- Small Compact Size - PCB Mount
- Single Output
- Output Range : 3.3VDC - 24VDC
- Input Range : 85VAC - 265VAC/47 - 63Hz Or 120VDC - 370VDC
- Very Low Standby Power Consumption < 0.15W
- Better Energetic Efficiency : Meet Requirements Of Energy Star And EC Code Of Conduct
- Encapsulated Design And Same Footprint As EE20 Transformer : Upgrade Your Application Without Redesign Of PCB

- Safety : IEC/EN61558-2-16, IEC/EN60950, IEC/EN60335, UL/CUL60950, CE, VDE, ENEC Mark
- Materials : Uses UL 94-V0 Plastic And Resin
- EMC : Conducted And Radiated Emissions Conform To EN55014 CLASS B, EN55032 CLASS B And FCC Part 15
- Immunity Conform To: EN61000-3-2 CLASS A, EN61000-3-3, IEC61000-4-2, IEC61000-4-3, IEC61000-4-4, IEC61000-4-5, IEC61000-4-6, IEC61000-4-11

Part Number	Output Power (W)	Output Voltage (Vdc)	Output Current (mA)	Output Load Regulation (%)	Max. Operating Ambient (°C)	Min. Part Efficiency(%)
48021	1	3.3	300	± 6	80	60
	2.5		750		60	63
	2.75		830		50	
48022	1	5	200	± 5	80	60
	2.5		500		60	65
	3		600		50	
48023	1	9	110	± 5	80	67
	2.5		280		70	70
	3		330		60	
48024	1	12	84	± 5	80	67
	2.5		210		70	72
	3		250		60	
48025	1	15	67	± 5	80	67
	2.5		170		70	72
	3		200		60	
48026	1	18	56	± 5	80	67
	2.5		140		70	72
	3		170		60	
48027	1	24	42	± 5	80	70
	2.5		105		70	74
	3		125		60	

DIMENSIONS and PINOUT

4 pins

PRI : Pins 1 – 5 : AC or DC Input

SEC : Pin 7 : DC Output +V

Pin 9 : DC Output 0V

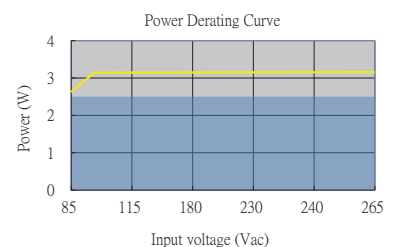
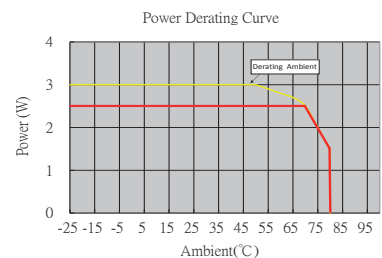
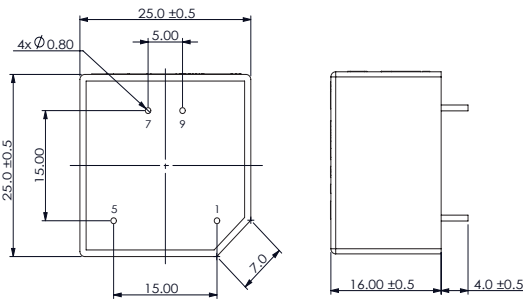

Model: 1 to 3 Watt		Specification
AC Input Characteristics	Rated AC input Voltage	100~240Vac or 140VDC-340VDC
	AC Input Voltage Range	85~265Vac or 120VDC-370VDC
	AC Input Frequency Range	47Hz~63Hz
	Rated AC Input Frequency	50/60Hz
	Input Current	0.15A Max@85Vac~265Vac, at full load
	Standby Power	0.15W Max(Meet Requirements Of Energy Star And EC Code Of Conduct)
DC Output Characteristics	Output Voltage Accuracy	3.3V type: $\pm 6\%$ Other types(5V,9V,12V,15V,18V and 24V): $\pm 5\%$
	Output Voltage Line Regulation	3.3V type: $\pm 5\%$ Other types(5V,9V,12V,15V,18V and 24V): $\pm 3\%$
	Output Voltage Load Regulation	3.3V type: $\pm 6\%$ Other types(5V,9V,12V,15V,18V and 24V): $\pm 5\%$
	Ripple & Noise	Max 200mVp-p@ Rated AC input, at nominal line (The measuring will be terminated with a 47uF AL E-Cap and a 0.1uF Ceramic-Cap. An oscilloscope set at 20MHz bandwidth)
	Dynamic Response	The output voltage shall not exceed $\pm 10\%$ rated output voltage @ 50% \leftarrow \rightarrow 100% Load change, 1A/uS , 1KHz 50% duty cycle
	Hold Up Time	5mS min@ 100Vac ~240Vac, DC output with full load
	Turn On Delay	3S max @ 85Vac~265Vac input and DC output with full load
	Rise Time	50ms max @ 85Vac~265Vac input and DC output with full load
	Overshoot	The output voltage shall not exceed +10% rated output voltage @ Power on and 85Vac~265Vac input, and DC with full load
	Undershoot	The output voltage shall not exceed -10% rated output voltage @ Power off and 85Vac~265Vac input and DC output with full load
	Efficiency	See table (Meets Requirements Of Energy Star And EC Code Of Conduct)
Protection Characteristics	Over Current Protection	The power supply shall automatic protect. The power supply shall auto-recover normal operation after the deformation is removed. No excessive heat, odor, or plastic deformation shall occur with no safety hazard
	Output Short Circuit Protection	The power supply shall withstand a continuous output short without damage in 24 hours; The short may be applied before power on, or after power on; The power supply shall resume normal operation after the short is removed, no excessive heat, odor, or plastic deformation shall occur with no safety hazard
	Over temperature protection	The power supply shall shut down when the junction temperature of PWM controller exceeds the thermal shutdown temperature, typically 140°C $\pm 10^\circ$ C
Environmental	Operation Temperature	-25°C ~+ (see table)
	Operation Humidity	10~ 90% RH(No Condensing) @ full load
	Storage Temperature	-40°C~ +85°C
	Storage Humidity	5%~95%
	Cooling Method	Ordinary or thermostat
Safety & EMC Requirement	Dielectric Strength	Primary to Secondary: 4000Vac 5mA, 3 secs.
	Radiation	Meeting EN55032,EN55014,FCC part 15, Class B. under 3dB margin
	Conduction	Meeting EN55032,EN55014, FCC part 15,Class B. under 3dB margin
	Harmonic Current Disturbance	Meeting EN61000-3-2:2014, Class A
	Voltage Fluctuation And Flicker	Meeting EN61000-3-3:2013
	Electrostatic Discharge	Meeting IEC61000-4-2:2008 Contact Discharge ± 4 KV,Air Discharge ± 8 KV
	RF Field Strength Susceptibility	Meeting IEC61000-4-3:2006+A1:2007+A2:2010
	Electrical Fast Transient	Meeting IEC61000-4-4:2012, ± 1 KV
	Lightning Surge	Meeting IEC61000-4-5:2014, ± 1 KV (surge level can be extended to 6KV with an external circuit - please refer to MYRRA's website and catalogue for MYRRA SMPS application notes).
	Conducted Susceptibility	Meeting IEC61000-4-6 : 2013
	Voltage Dips And Interruptions	Meeting IEC61000-4-11 : 2004
	Safety Standards	Meet all requirements of : UL/CUL60950, UL/CUL62368, IEC/EN60950, IEC/EN60335,IEC/EN61558-2-16, IEC/EN62368, CE, VDE, ENEC Mark
Reliability Requirement	MTBF	Calculated by MIL-HDBK-217-F2 >200K Hours @230VAC input at max operation temperature; >550K Hours @230VAC input at 25deg.C
	Burn-In Test	The unit shall be burned in for 2~ 5hours under 230Vac input and DC with full load at an ambient temperature of 30~45 degrees C
Net Weight	About 16 grams per product unit	
Guarantee	This product meets RoHS standard	

we reserve the right to change specifications in this document without notice



ONE OUTPUT 2.5W to 5W

MAIN FEATURES

- 2.5 To 5W Small Compact Size - PCB Mount
- Single Output
- Output Range : 3.3VDC - 24VDC
- Input Range : 85VAC - 265VAC/47 - 63Hz Or 120VDC - 370VDC
- Very Low Standby Power Consumption < 0.2W
- Better Energetic Efficiency : Meet Requirements Of Energy Star And EC Code Of Conduct
- Encapsulated Design And Same Footprint As EI30 Transformer : Upgrade Your Application Without Redesign Of PCB

- Safety : Meets All Requirements of: IEC/EN61558-2-16, IEC/EN60950, IEC/EN60335, UL/CUL60950, CE, VDE, ENEC Mark
- Materials : Uses UL 94-V0 Plastic And Resin
- EMC : Conducted And Radiated Emissions Conform To EN55014, EN55032, CLASS B
- Immunity Conform To: EN61000-3-2 CLASS A, EN61000-3-3, IEC61000-4-2, IEC61000-4-3, IEC61000-4-4, IEC61000-4-5, IEC61000-4-6, IEC61000-4-11

Part Number	Output Power (W)	Output voltage (Vdc)	Output current (mA)	Output Load Regulation (%)	Max. Operating Ambient (°C)	Min. Part Efficiency(%)
47121	2.5	3.3	750	± 2	70	65
47122	2.75	5	550			68
47123	2.5	9	270			72
47124		12	210			74
47125		15	170			75
47126		24	110			77
47151		4.5	3.3			1350
47152	5		900		68	
47153	5	9	550		72	
47154		12	420		75	
47155		15	320		76	
47156		24	220		79	
47157	4.5	3.8	1180		66	

Special Version : 4712xSLI and 4715xSLI = 19.2mm case height (x=1, 2, 3, 4, 5, 6 or 7)

DIMENSIONS and PINOUT

4 pins
 pins 1 & 5 : AC or DC Input
 pin 7 : DC output +V
 pin 9 : DC output 0V

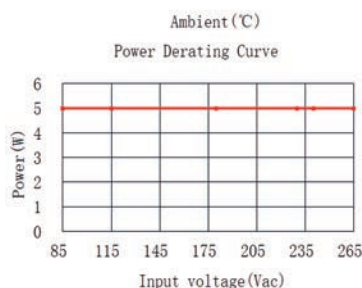
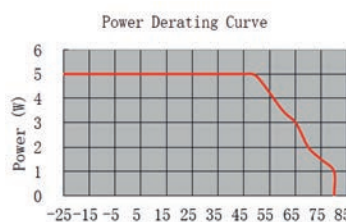
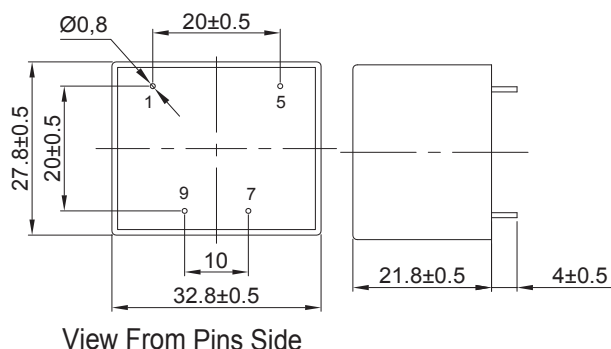

Model: 2.5 To 5 Watt		Specification
AC Input Characteristics	Rated AC input Voltage	100~240Vac Or 140VDC-340VDC
	AC Input Voltage Range	85~265Vac Or 120VDC-370VDC
	AC Input Frequency Range	47Hz-63Hz
	Rated AC Input Frequency	50/60Hz
	Input Current	0.2A Max@85Vac~265Vac, at full load
	Standby Power	0.3W Max(Meet Requirements Of Energy Star And EC Code Of Conduct)
DC Output Characteristics	Output Voltage Accuracy	± 5%
	Output Voltage Line Regulation	± 3%
	Output Voltage Load Regulation	± 5%
	Ripple & Noise	Max 200mVp-p@ Rated AC input(The measuring will be terminated with a 47uF AL E-Cap and a 0.1uF Cer-Cap. An oscilloscope set at 20MHz bandwidth)
	Efficiency	See Table (Meet Requirements Of Energy Star And EC Code Of Conduct)
Protection Characteristics	Over Current Protection	The power supply shall automatic protection. The power supply shall autorecovery normal operation after the deformation is removed. No excessive heat, odor, or plastic deformation shall occur, no safety hazard
	Output Short Circuit Protection	The power supply shall withstand a continuous output short without damage in 24 hours ; The short may be applied before power on, or after power on ; The power supply shall resume normal operation after the short is removed, no excessive heat, odor, or plastic deformation shall occur, no safety hazard
	Over Temperature Protection	The power supply shall shut down when the junction temperature of PWM controller exceeds the thermal shutdown temperature, typically 140°C ±10°C
Environmental	Operation Temperature	-25°C ~+ (see table)
	Operation Humidity	10~ 90% RH(No Condensing) @ full load
	Storage Temperature	-40°C~ +85°C
	Storage Humidity	5%~95%
Safety & EMC Requirement	Dielectric Strength	Primary to Secondary: 4000Vac 5mA, 3 sec.
	Radiation	Meet EN55032,EN55014 , Class B. under 3dB margin
	Conduction	Meet EN55032,EN55014, Class B. under 3dB margin
	Safety Standards	Meet all requirements of UL/CUL60950 - IEC/EN60950 - IEC/EN60335 - EC/EN61558-2-16 CE,VDE, And ENEC Mark VDE Approval No. 40034334 - UL Approval No.E345767
Reliability Requirement	MTBF	Calculated by MIL-HDBK-217-F2 550K Hours Min. @230VAC input, 25deg.C
	Burn-In Test	The unit shall be burned in for 2~ 5hours under 230Vac input and DC with full load at an ambient temperature of 30~45 degrees C
Net Weight	About 30 grams per product unit	
Guarantee	This product meet to RoHS standard	

ONE OUTPUT 2.4W to 5W



MAIN FEATURES

- 2.4W to 5W Small Compact Size - PCB Mount
- Single Output
- Output Range : 5.5VDC - 24VDC
- Input Range : 85VAC - 265VAC/47 - 63Hz Or 120VDC - 370VDC
- Very Low Standby Power Consumption < 0.3W
- Better Energetic Efficiency : Meet Requirements Of Energy Star
- Encapsulated Design And Same Footprint As EI30 Transformer : Upgrade Your Application Without Redesign Of PCB

- Safety : Meets All Requirements of: IEC/EN61558-2-16, IEC/EN60950, IEC/EN60335, UL/CUL60950, CE, VDE, ENEC Mark
- Materials : Uses UL 94-V0 Plastic And Resin
- EMC : Conducted And Radiated Emissions Conform To EN55014, EN55032, CLASS B
- Immunity Conform To: EN61000-3-2 CLASS A, EN61000-3-3, IEC61000-4-2, IEC61000-4-3, IEC61000-4-4, IEC61000-4-5, IEC61000-4-6, IEC61000-4-11

Part Number	Output Power (W)	Output Voltage (Vdc)	Output Current (mA)	Output Load Regulation (%)	Ambient (°C)	Min. Part Efficiency(%)
47114	2.4	12	200	± 5	70	74
47132	2.5	5	500			68
47133	3.2	9	360			73
47134		12	270			75
47135		18	180			78
47136		24	130			80
47162	5	5	900		50	68
47163		9	560			73
47164		12	420			75
47165		18	280			78
47166		24	210			80

DIMENSIONS and PINOUT

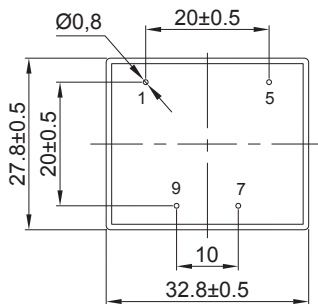

View From Pins Side

4 pins
 pins 1 & 5 : AC or DC Input
 pin 7 : DC output +V
 pin 9 : DC output 0V

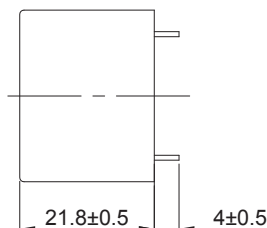

Power Derating Curve

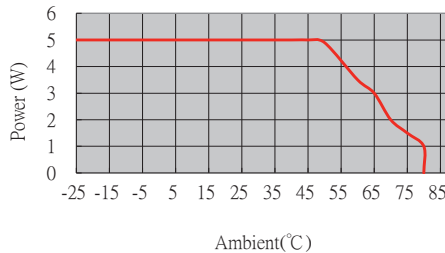

Power Derating Curve

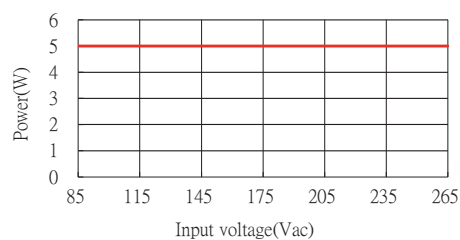

Model: 2.5 To 5 Watt		Specification
AC Input Characteristics	Rated AC input Voltage	100~240Vac Or 140VDC-340VDC
	AC Input Voltage Range	85~265Vac Or 120VDC-370VDC
	AC Input Frequency Range	47Hz-63Hz
	Rated AC Input Frequency	50/60Hz
	Input Current	0.2A Max@85Vac~265Vac, at full load
	Standby Power	0.3W Max(Meet Requirements Of Energy Star And EC Code Of Conduct)
DC Output Characteristics	Output Voltage Accuracy	± 5%
	Output Voltage Line Regulation	± 3%
	Output Voltage Load Regulation	± 5%
	Ripple & Noise	Max 200mVp-p@ Rated AC input(The measuring will be terminated with a 47uF AL E-Cap and a 0.1uF Cer-Cap. An oscilloscope set at 20MHz bandwidth)
	Efficiency	See Table (Meet Requirements Of Energy Star And EC Code Of Conduct)
Protection Characteristics	Over Current Protection	The power supply shall automatic protection. The power supply shall autorecovery normal operation after the deformation is removed. No excessive heat, odor, or plastic deformation shall occur, no safety hazard
	Output Short Circuit Protection	The power supply shall withstand a continuous output short without damage in 24 hours ; The short may be applied before power on, or after power on ; The power supply shall resume normal operation after the short is removed, no excessive heat, odor, or plastic deformation shall occur, no safety hazard
	Over Temperature Protection	The power supply shall shut down when the junction temperature of PWM controller exceeds the thermal shutdown temperature, typically 140°C ±10°C
Environmental	Operation Temperature	-25°C ~+ (see table)
	Operation Humidity	10~ 90% RH(No Condensing) @ full load
	Storage Temperature	-40°C~ +85°C
	Storage Humidity	5%~95%
Safety & EMC Requirement	Dielectric Strength	Primary to Secondary: 4000Vac 5mA, 3 sec.
	Radiation	Meet EN55032,EN55014 , Class B. under 3dB margin
	Conduction	Meet EN55032,EN55014, Class B. under 3dB margin
	Safety Standards	Meet all requirements of UL/CUL60950 - IEC/EN60950 - IEC/EN60335 - IEC/EN61558-2-16 CE,VDE, And ENEC Mark VDE Approval No. 40034334 - UL Approval No.E345767
Reliability Requirement	MTBF	Calculated by MIL-HDBK-217-F2 550K Hours Min. @230VAC input, 25deg.C
	Burn-In Test	The unit shall be burned in for 2~ 5hours under 230Vac input and DC with full load at an ambient temperature of 30~45 degrees C
Net Weight	About 30 grams per product unit	
Guarantee	This product meet to RoHS standard	

TWO OUTPUTS - COMMON 3W to 5W



MAIN FEATURES

- 3W To 5W Small Compact Size - PCB Mount
- Two Common Output
- Output Voltage Accuracy : See Table For 15 to 100% Rated Load Of Each Output (includes line and load variations)
- Input Range : 85VAC - 265VAC/47 - 63Hz Or 120VDC - 370VDC
- Very Low Standby Power Consumption < 0.2W
- Better Energetic Efficiency : Meet Requirements Of Energy Star

- Encapsulated Design And Same Footprint As EI30 Transformer : Upgrade Your Application Without Redesign Of PCB
- Safety : Meets All Requirements of: IEC/EN61558-2-16, IEC/EN60950, IEC/EN60335, UL/CUL60950, CE, VDE, ENEC Mark
- Materials : Uses UL 94-V0 Plastic And Resin
- EMC : Conducted And Radiated Emissions Conform To EN55014, EN55032, CLASS B
- Immunity Conform To: EN61000-3-2 CLASS A, EN61000-3-3, IEC61000-4-2, IEC61000-4-3, IEC61000-4-4, IEC61000-4-5, IEC61000-4-6, IEC61000-4-11

Part Number	Output Power (W)	Output Voltage (Vdc)	Output Current (mA)	Output Load Regulation (%)	Max. Operating Ambient (°C)	Min. Part Efficiency(%)
47243	4.7	(+)10.5 (+) 7.0	380 100	± 3 ± 15	50	72
47244	5	(+) 15 (+) 7.0	300 70	± 3 ± 15		73
47245	3.2	(+) 12 (+) 5.5	130 300	± 5 ± 10	70	65
47246	4	(+) 5.0 (+) 12	400 (600max) 170	± 3 ± 15	60	
47247		(+) 15 (+) 15	130 130	± 8 ± 8		

Notes : The dual DC Voltage Outputs share a Common OV reference.
Power deration must be considered at higher Operating Ambient Temperatures.

DIMENSIONS and PINOUT

5 pins

pins 1 & 5: AC or DC Input
pin 6: Common output 0V
pin 7: DC output 1
pin 10: DC output 2

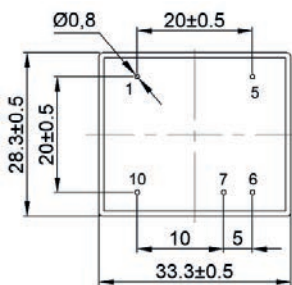

View From Pins Side

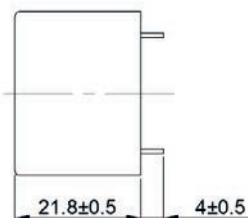

Power Derating Curve

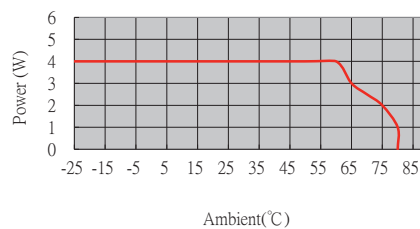

Ambient(°C)

Power Derating Curve

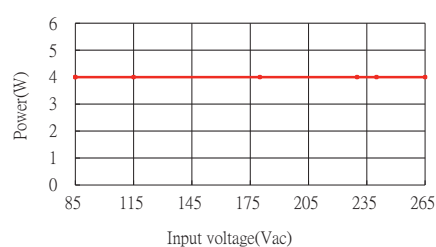

Input voltage(Vac)



Model: Two Common Outputs 3 TO 5W		Specification
AC Input Characteristics	Rated AC input Voltage	100~240Vac Or 140VDC-340VDC
	AC Input Voltage Range	85~265Vac Or 120VDC-370VDC
	AC Input Frequency Range	47Hz~63Hz
	Rated AC Input Frequency	50/60Hz
	Input Current	0.2A Max@85Vac~265Vac, at full load
	Standby Power	0.2W Max (Meet Requirements Of Energy Star And EC Code Of Conduct)
DC Output Characteristics	Output Voltage Accuracy	See Table For 15 To 100% Rated Load Of Each Output (includes line and load variations)
	Efficiency	See Table(Meet Requirements Of Energy Star And EC Code Of Conduct)
Protection Characteristics	Over Current Protection	The power supply shall automatic protection. The power supply shall autorecovery normal operation after the deformation is removed. No excessive heat, odor, or plastic deformation shall occur, no safety hazard
	Output Short Circuit Protection	The power supply shall withstand a continuous output short without damage in 24 hours; The short may be applied before power on, or after power on ; The power supply shall resume normal operation after the short is removed, no excessive heat, odor, or plastic deformation shall occur, no safety hazard
	Over Temperature Protection	The power supply shall shut down when the junction temperature of PWM controller exceeds the thermal shutdown temperature, typically 140°C±10°C.
Environmental	Operation Temperature	-25°C ~ +Ta (see table)
	Operation Humidity	10~ 90% RH(No Condensing) @ full load
	Storage Temperature	-40°C~ +85°C
	Storage Humidity	5%~95%
Safety & EMC Requirement	Dielectric Strength	Primary to Secondary: 4000Vac 5mA, 3 sec.
	Radiation	Meet EN55032,EN55014, Class B. under 3dB margin
	Conduction	Meet EN55032,EN55014,Class B. under 3dB margin
	Safety Standards	Meets all requirements of UL/CUL60950 IEC/EN60950 IEC/EN60335 IEC/EN61558-2-16 CE,VDE, And ENEC Mark VDE Approval No. 40034334 UL Approval No.E345767
Reliability Requirement	MTBF	Calculated by MIL-HDBK-217-F2 550K Hours Min. @230VAC input, 25deg.C
	Burn-In Test	The unit shall be burned in for 2~ 5hours under 230Vac input and DC with full load at an ambient temperature of 30~45 degrees C
Net Weight	About 30 grams per product unit	
Guarantee	This product meet to RoHS standard	

Model : Two Common Outputs 3 TO 5W		Specification
AC Input Characteristics	Rated AC input Voltage	100~240Vac Or 140VDC-340VDC
	AC Input Voltage Range	85~265Vac Or 120VDC-370VDC
	AC Input Frequency Range	47Hz-63Hz
	Rated AC Input Frequency	50/60Hz
	Input Current	0.2A Max@85Vac~265Vac, at full load
	Standby Power	0.2W Max (Meet Requirements Of Energy Star And EC Code Of Conduct)
DC Output Characteristics	Output Voltage Accuracy	See Table For 15 To 100% Rated Load Of Each Output (includes line and load variations)
	Efficiency	See Table(Meet Requirements Of Energy Star And EC Code Of Conduct)
Protection Characteristics	Over Current Protection	The power supply shall automatic protection. The power supply shall autorecovery normal operation after the deformation is removed. No excessive heat, odor, or plastic deformation shall occur, no safety hazard
	Output Short Circuit Protection	The power supply shall withstand a continuous output short without damage in 24 hours; The short may be applied before power on, or after power on ; The power supply shall resume normal operation after the short is removed, no excessive heat, odor, or plastic deformation shall occur, no safety hazard
	Over Temperature Protection	The power supply shall shut down when the junction temperature of PWM controller exceeds the thermal shutdown temperature, typically 140°C±10°C.
Environmental	Operation Temperature	-25°C ~ +Ta (see table)
	Operation Humidity	10~ 90% RH(No Condensing) @ full load
	Storage Temperature	-40°C~ +85°C
	Storage Humidity	5%~95%
Safety & EMC Requirement	Dielectric Strength	Primary to Secondary: 4000Vac 5mA, 3 sec.
	Radiation	Meet EN55032,EN55014, Class B. under 3dB margin
	Conduction	Meet EN55032,EN55014,Class B. under 3dB margin
	Safety Standards	Meets all requirements of UL/CUL60950 IEC/EN60950 IEC/EN60335 IEC/EN61558-2-16 CE,VDE, And ENEC Mark VDE Approval No. 40034334 UL Approval No.E345767
Reliability Requirement	MTBF	Calculated by MIL-HDBK-217-F2 550K Hours Min. @230VAC input, 25deg.C
	Burn-In Test	The unit shall be burned in for 2~ 5hours under 230Vac input and DC with full load at an ambient temperature of 30~45 degrees C
Net Weight	About 30 grams per product unit	
Guarantee	This product meet to RoHS standard	

ONE OUTPUT 7.5W



MAIN FEATURES

- 7.5W Small Compact Size - PC B Mount
- Single Output
- Output Range : 3.3VDC - 24VDC
- Input Range : 85VAC - 265VAC/47 - 63Hz Or 120VDC - 370VDC
- Very Low Standby Power Consumption < 0.15W
- Better Energetic Efficiency : Meet Requirements Of Energy Star
- Encapsulated Design And Same Footprint As EI38 Transformer : Upgrade Your Application Without Redesign Of PCB

- Safety : Meets All Requirements of: IEC/EN61558-2-16, IEC/EN60950, IEC/EN60335, UL/CUL60950, CE, VDE, ENEC Mark
- Materials : Uses UL 94-V0 Plastic And Resin
- EMC : Conducted And Radiated Emissions Conform To EN55014, EN55032, CLASS B and FFC Part15
- Immunity Conform To: EN61000-3-2 CLASS A, EN61000-3-3, IEC61000-4-2, IEC61000-4-3, IEC61000-4-4, IEC61000-4-5, IEC61000-4-6, IEC61000-4-11

Part Number	Output Power (W)	Output Voltage (Vdc)	Output Current (mA)	Output Load Regulation (%)	Max. Operating Ambient (°C)	Min. Part Efficiency(%)
47206	7.5	3.3	2270	± 3	50	74
47200		5	1500	± 2	70	77
47201		9	830			80
47202		12	625			82
47203		15	500			
47204		18	420			
47205		24	310			



DIMENSIONS and PINOUT

4 pins
 pins 1 & 5 : AC or DC Input
 pin 7 : DC output +V
 pin 9 : DC output 0V

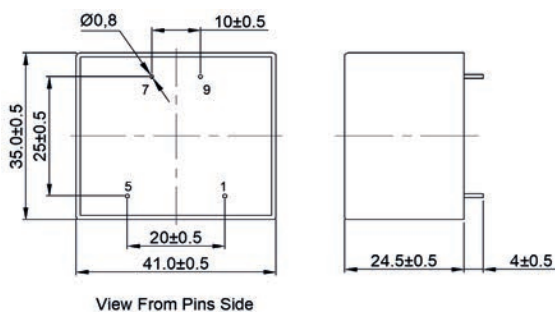

Power Derating Curve

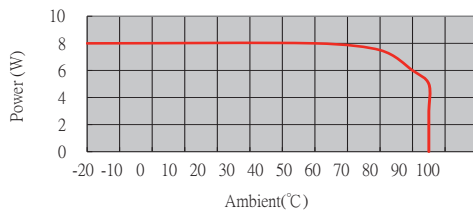

Power Derating Curve

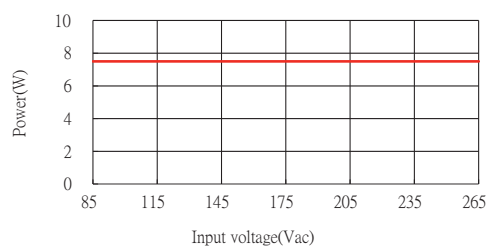

Model: 7.5 Watt		Specification
AC Input Characteristics	Rated AC input Voltage	100~240Vac Or 140VDC-340VDC
	AC Input Voltage Range	85~265Vac Or 120VDC-370VDC
	AC Input Frequency Range	47Hz~63Hz
	Rated AC Input Frequency	50/60Hz
	Input Current	0.3A Max@85Vac~265Vac, at full load
	Standby Power	0.15W Max(Meet Requirements Of Energy Star And EC Code Of Conduct)
DC Output Characteristics	Output Voltage Accuracy	± 2% (5V,9V,12V,15V,18V,24V Types) - ± 3%(3.3V Type)
	Output Voltage Line Regulation	± 0.5%
	Output Voltage Load Regulation	± 1%(5V,9V,12V,15V,18V,24V Types) ± 3%(3.3V Type)
	Ripple & Noise	Max 180mVp-p@ Rated AC input, at nominal line (The measuring will be terminated with a 47uF AL E-Cap and a 0.1uF Cer-Cap. An oscilloscope set at 20MHz bandwidth)
	Efficiency	Meet Requirements Of Energy Star And EC Code Of Conduct
Protection Characteristics	Over Current Protection	The power supply shall automatic protection. The power supply shall autorecovery normal operation after the deformation is removed. No excessive heat, odor, or plastic deformation shall occur, no safety hazard
	Output Short Circuit Protection	The power supply shall withstand a continuous output short without damage in 24 hours; The short may be applied before power on, or after power on; The power supply shall resume normal operation after the short is removed, no excessive heat, odor, or plastic deformation shall occur, no safety hazard
Environmental	Operation Temperature	-20°C ~ +Ta (see table)
	Operation Humidity	10~ 90% RH(No Condensing) @ full load
	Storage Temperature	-40°C~ +85°C
	Storage Humidity	5%~95%
Safety & EMC Requirement	Dielectric Strength	Primary to Secondary: 4000Vac 5mA, 3 sec.
	Radiation	Meet EN55032,EN55014,FCC, part 15, Class B. under 3dB margin
	Conduction	Meet EN55032,EN55014, FCC, part 15,Class B. under 3dB margin
	Safety Standards	Meet all requirements of UL/CUL60950 IEC/EN60950 IEC/EN60335 IEC/EN61558-2-16 CE,VDE and ENEC Mark
Reliability Requirement	MTBF	Calculated by MIL-HDBK-217-F2 550K Hours Min. @230VAC input, 25deg.C
	Burn-In Test	The unit shall be burned in for 2~ 5hours under 230Vac input and DC with full load at an ambient temperature of 30~45 degrees C
Net Weight	About 56 grams per product unit	
Guarantee	This product meet to RoHS standard	

ONE OUTPUT 10W



MAIN FEATURES

- 10W Small Compact Size - PC B Mount
- Single Output
- Output Range : 3.3VDC - 24VDC
- Input Range : 85VAC - 265VAC/47 - 63Hz Or 120VDC - 370VDC
- Very Low Standby Power Consumption < 0.10W
- Better Energetic Efficiency : Meet Requirements Of Energy Star
- Encapsulated Design And Same Footprint As EI48 Transformer : Upgrade Your Application Without Redesign Of PCB

- Safety : Meets All Requirements of: IEC/EN61558-2-16, IEC/EN60950, IEC/EN60335, UL/CUL60950, CE, VDE, ENEC Mark
- Materials : Uses UL 94-V0 Plastic And Resin
- EMC : Conducted And Radiated Emissions Conform To EN55014, EN55032, CLASS B and FCC Part 15
- Immunity Conform To: EN61000-3-2 CLASS A, EN61000-3-3, IEC61000-4-2, IEC61000-4-3, IEC61000-4-4, IEC61000-4-5, IEC61000-4-6, IEC61000-4-11

Part Number	Output Power (W)	Output Voltage (Vdc)	Output Current (mA)	Output Load Regulation (%)	Max. Operating Ambient (°C)	Min. Part Efficiency(%)
47210	10	5	2000	± 3	60	74
47211		9	1100	± 2		80
47212		12	830			82
47213		15	670			
47214		18	560		50	72
47215		24	420			
47216		3.3	3000	± 4		

DIMENSIONS and PINOUT

4 pins

pins 1 & 5 : AC or DC Input
pin 7 : DC output +V
pin 9 : DC output 0V

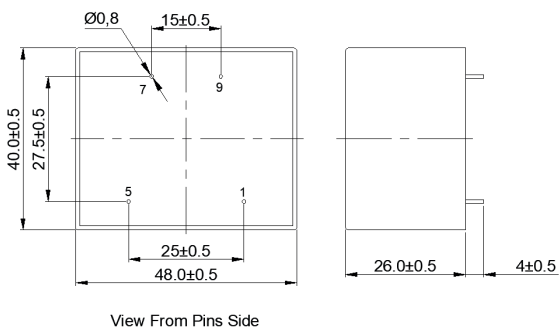

Power Derating Curve

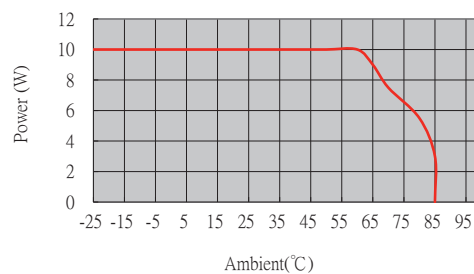

Power Derating Curve

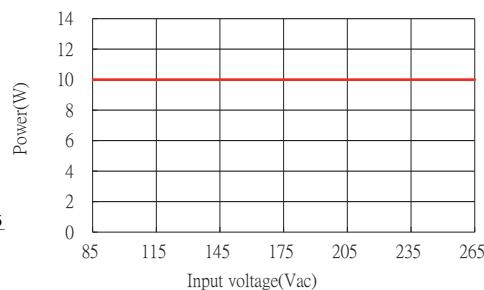

Model: 10 Watt		Specification
AC Input Characteristics	Rated input Voltage	100~240Vac Or 140VDC-340VDC
	Input Voltage Range	85~265Vac Or 120VDC-370VDC
	AC Input Frequency Range	47Hz~63Hz
	Rated AC Input Frequency	50/60Hz
	Input Current	0.4A Max@85Vac~265Vac, at full load
	Standby Power	0.1W Max(Meet Requirements Of Energy Star And EC Code Of Conduct)
DC Output Characteristics	Output Voltage Accuracy	± 2% (9V,12V,15V,18V,24V Types), ± 3% (5V Type), ± 4%(3.3V Type)
	Output Voltage Line Regulation	± 0.5%(9V,12V,15V,18V,24V Types), ± 1%(3.3V and 5V Types)
	Output Voltage Load Regulation	± 1%(9V,12V,15V,18V,24V Types) ± 3% (5V Type), ± 4%(3.3V Type)
	Ripple & Noise	Max 150mVp-p @Rated AC input (The measuring will be terminated with a 47uF AL E-Cap and a 0.1uF Cer-Cap. An oscilloscope set at 20MHz bandwidth)
	Efficiency	Meets Requirements Of Energy Star And EC Code Of Conduct
Protection Characteristics	Over Current Protection	The power supply shall automatic protection. The power supply shall auto-recovery normal operation after the deformation is removed. No excessive heat, odor, or plastic deformation shall occur, no safety hazard
	Output Short Circuit Protection	The power supply shall withstand a continuous output short without damage in 24 hours; The short may be applied before power on, or after power on; The power supply shall resume normal operation after the short is removed, no excessive heat, odor, or plastic deformation shall occur, no safety hazard
Environmental	Operation Temperature	-25°C ~ +Ta (see table)
	Operation Humidity	10~ 90% RH(No Condensing) @ full load
	Storage Temperature	-40°C~ +85°C
	Storage Humidity	5%~95%
Safety & EMC Requirement	Dielectric Strength	Primary to Secondary: 4000Vac 5mA, 3 sec .
	Radiation	Meeting EN55032,EN55014,FCC part 15, Class B. under 3dB margin
	Conduction	Meeting EN55032,EN55014, FCC part 15,Class B. under 3dB margin
	Safety Standards	Meet all requirements of UL/CUL60950 IEC/EN60950 IEC/EN60335 IEC/EN61558-2-16 CE,VDE,And ENEC Mark VDE Approval No. 40044416 UL Approval No.E345767
Reliability Requirement	MTBF	Calculated by MIL-HDBK-217-F2 5V ,9V,12V,15V,18V,24V Types: 200K Hours Min. @230VAC input, 60deg.C 3.3V type:200K Hours Min. @230VAC input, 50deg.C
	Burn-In Test	The unit shall be burned in for 2~ 5hours under 230Vac input and DC with full load at an ambient temperature of 30~45 degrees C
Net Weight	About 80.2 grams per product unit.	
Guarantee	This product meet to RoHS standard	

we reserve the right to change specifications in this document without notice

ONE OUTPUT 20W

MAIN FEATURES

- 20W Small Compact Size - PCB Mount
- Single Output
- Output Range : 3.3VDC - 24VDC
- Input Range : 85VAC - 265VAC/47 - 63Hz Or 120VDC - 370VDC
- Very Low Standby Power Consumption = 0.1W
- Better Energetic Efficiency : Meet Requirements Of Energy Star And EC Code Of Conduct
- Encapsulated Design
PCB Total Power Solution

- Safety : Complies with IEC/EN61558-2-16, IEC/EN60950, IEC/EN60335, UL/CUL60950, CE.
- Materials : Uses UL 94-V0 Plastic And Resin
- EMC : Conducted And Radiated Emissions Conform To EN55014 CLASS B, EN55032 CLASS B And FCC Part 15
- Immunity Conform To:
EN61000-3-2 CLASS A, EN61000-3-3, IEC61000-4-2, IEC61000-4-3, IEC61000-4-4, IEC61000-4-5, IEC61000-4-6, IEC61000-4-11

Part Number	Output Power (W)	Output voltage (Vdc)	Output current (mA)	Output Load Regulation (%)	Max.Operating Ambient (°C)	Min. Part Efficiency (%)
47220	15	3.3	4500	± 4	50	82
47221	20	5	4000			
47222		9	2200			
47223		12	1700			
47224		15	1400			
47225		18	1100			
47226		24	840	± 3	60	85

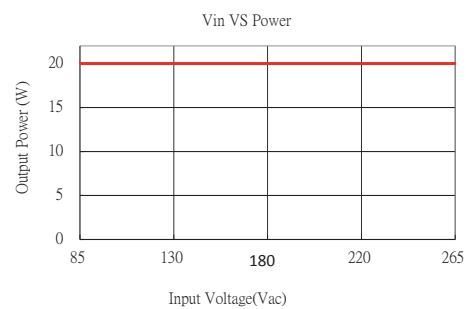
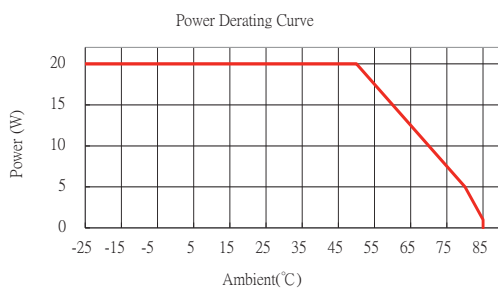

DIMENSIONS and PINOUT

4 pins
pins 1 & 5 : AC or DC Input
pin 7 : DC output +V
pin 9 : DC output 0V

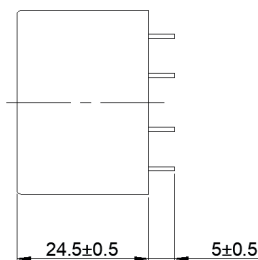
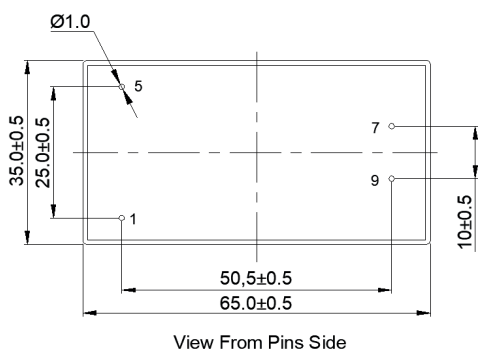

@ pending certification

Model: 20 Watt		Specification
AC Input Characteristics	Rated input Voltage	100~240Vac Or 140VDC-340VDC
	Input Voltage Range	85~265Vac Or 120VDC-370VDC
	AC Input Frequency	47Hz~63Hz
	Rated AC Input Frequency	50/60Hz
	Input Current	0.6A Max@85Vac~265Vac, at full load
	Standby Power	0.15W Max (Meets requirements Of Energy Star And EC Code Of Conduct)
DC Output Characteristics	Output Voltage Accuracy	± 3% (9V, 12V, 15V, 18V, 24V Types)
		± 4% (3.3V Type, 5V Type)
	Output Voltage Line Regulation	± 2% (9V, 12V, 15V, 18V, 24VTypes)
		± 3% (3.3V and 5V Types)
	Output Voltage Load Regulation	± 3% (9V, 12V, 15V, 18V, 24V Types) ± 4% (3.3V Type, 5V Type)
Ripple & Noise	Max 180mVp-p @Rated AC input (The measuring will be terminated with a 47uF AL E-Cap and a 0.1uF Cer-Cap. An oscilloscope set at 20MHz bandwidth)	
Efficiency	Meets requirements Of Energy Star And EC Code Of Conduct	
Protection Characteristics	Over Current Protection	The power supply shall automatically protect. The power supply shall auto-recover normal operation after the deformation is removed. No excessive heat, odor, or plastic deformation shall occur, no safety hazard
	Output Short Circuit Protection	The power supply shall withstand a continuous output short without damage in 24 hours; The short may be applied before power on, or after power on; The power supply shall resume normal operation after the short is removed, no excessive heat, odor, or plastic deformation shall occur, no safety hazard
Environmental	Operation Temperature	-25°C ~+50°C (see derating curve)
	Operation Humidity	10~ 90% RH (No Condensing) @ full load
	Storage Temperature	-40°C~ +85°C
	Storage Humidity	5%~95%
Safety & EMC Requirement	Dielectric Strength	Primary to Secondary: 4000Vac 5mA, 3 sec .
	Radiation	Meeting EN55032, EN55014, FCC part 15, Class B. under 3dB margin
	Conduction	Meeting EN55032, EN55014, FCC part 15, Class B. under 3dB margin
	Safety Standards	Meet all requirements of : UL/CUL62368 - IEC/EN60335 - IEC/EN61558-2-16 - IEC/EN62368 -
Reliability Requirement	MTBF	Calculated by MIL-HDBK-217-F2 200K Hours Minimum @230VAC input, 50deg.C
	Burn-In Test	The unit shall be burned in for 2~ 5hours under 230Vac input and DC with full load at an ambient temperature of 30~45 degrees C
Mechanical	Physical Size	The units do not including PINs of input and output , and dimension is : (L)65*(W)35*(H)24.5± 0.5mm (see appearance drawing)
	Net Weight	Approximately 92 grams per product unit.
Guarantee	This product meets RoHS standard	

ONE OUTPUT 40W

MAIN FEATURES

- Small Compact Size - PCB Mount
- Single Output
- Output Range : 5VDC - 24VDC
- Input Range : 85VAC - 265VAC/47 - 63Hz Or 120VDC - 370VDC
- Very Low Standby Power Consumption = 0.1W
- Better Energetic Efficiency : Meet Requirements Of Energy Star And EC Code Of Conduct
- Encapsulated Design
PCB Total Power Solution

- Safety : Complies with IEC/EN61558-2-16, IEC/EN60950, IEC/EN60335, UL/CUL60950, CE.
- Materials : Uses UL 94-V0 Plastic And Resin
- EMC : Conducted And Radiated Emissions Conform To EN55014 CLASS B, EN55032 CLASS B And FCC Part 15
- Immunity Conform To:
EN61000-3-2 CLASS A, EN61000-3-3,
IEC61000-4-2, IEC61000-4-3, IEC61000-4-4,
IEC61000-4-5, IEC61000-4-6, IEC61000-4-11

Part Number	Output Power (W)	Output Voltage (Vdc)	Output Current (mA)	Output Load Regulation (%)	Max.Operating Ambient (°C)	Min. Part Efficiency (%)
47231	30	5	6000	± 5	50	82
47232	36	9	4000	± 3		85
47233	40	12	3300			
47234		15	2700			
47235		18	2200			
47236		24	1700			



DIMENSIONS and PINOUT

4 pins
pins 1 & 5 : AC or DC Input
pin 7 : DC output +V
pin 9 : DC output 0V

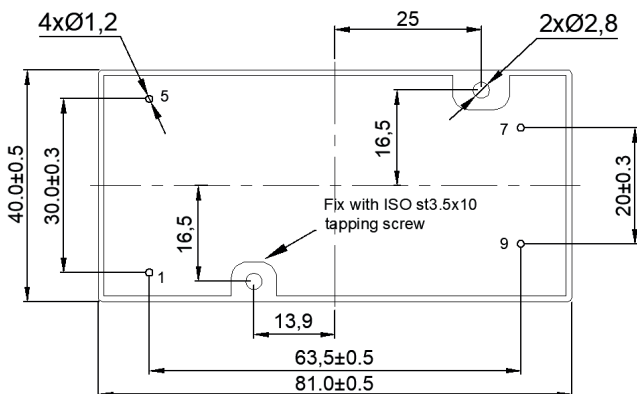

View From Pins Side



@ pending certification

Model: 40 Watt		Specification
AC Input Characteristics	Rated input Voltage	100~240Vac Or 140VDC-340VDC
	Input Voltage Range	85~265Vac Or 120VDC-370VDC
	AC Input Frequency Range	47Hz~63Hz
	Rated AC Input Frequency	50/60Hz
	Input Current	0.8A Max@85Vac~265Vac, at full load
	Standby Power	0.15W Max (Meet Requirements Of Energy Star And EC Code Of Conduct)
DC Output Characteristics	Output Voltage Accuracy	± 3% (9V, 12V, 15V, 18V, 24V Types) ± 5% (5V Type)
	Output Voltage Line Regulation	± 2% (9V, 12V, 15V,18V, 24V Types) ± 3% (5V Types)
	Output Voltage Load Regulation	± 3% (9V, 12V, 15V,18V, 24V Types) ± 5% (5V Type)
	Ripple & Noise	Max 200mVp-p @Rated AC input (The measuring will be terminated with a 47uF AL E-Cap and a 0.1uF Cer-Cap. An oscilloscope set at 20MHz bandwidth)
	Efficiency	See table (Meet Requirements Of Energy Star And EC Code Of Conduct)
Protection Characteristics	Over Current Protection	The power supply shall automatic protection. The power supply shall auto-recovery normal operation after the deformation is removed. No excessive heat, odor, or plastic deformation shall occur, no safety hazard
	Output Short Circuit Protection	The power supply shall withstand a continuous output short without damage in 24 hours; The short may be applied before power on, or after power on; The power supply shall resume normal operation after the short is removed, no excessive heat, odor, or plastic deformation shall occur, no safety hazard
Environmental	Operation Temperature	-25°C ~ + 50°C (see derating curve)
	Operation Humidity	10~ 90% RH (Non Condensing) @ full load
	Storage Temperature	-40°C~ +85°C
	Storage Humidity	5%~95%
Safety & EMC Requirement	Dielectric Strength	Primary to Secondary : 4000Vac 5mA, 3 sec.
	Radiation	Meeting EN55032, EN55014, FCC part 15, Class B. under 3dB margin
	Conduction	Meeting EN55032, EN55014, FCC part 15, Class B. under 3dB margin
	Safety Standards	Meet all requirements of:UL/CUL62368 - IEC/EN60335 - IEC/EN61558-2-16 - IEC/EN62368
Reliability Requirement	MTBF	Calculated by MIL-HDBK-217-F2 200K Hours minimum @230VAC input, 50deg.C
	Burn-In Test	The unit shall be burned in for 2~ 5hours under 230Vac input and DC with full load at an ambient temperature of 30~45 degrees C
	Net Weight	Approximately 150 grams per product unit.
Guarantee	This product meet to RoHS standard	

we reserve the right to change specifications in this document without notice

ONE OUTPUT 60W

MAIN FEATURES

- Small Compact Size - PCB Mount
- Single Output
- Output Range : 5VDC - 24VDC
- Input Range : 85VAC - 265VAC/47 - 63Hz Or 120VDC - 370VDC
- Very Low Standby Power Consumption = 0.1W
- Better Energetic Efficiency : Meet Requirements Of Energy Star And EC Code Of Conduct
- Encapsulated Design
PCB Total Power Solution

- Safety : Complies with IEC/EN61558-2-16, IEC/EN60950, IEC/EN60335, UL/CUL60950, CE.
- Materials : Uses UL 94-V0 Plastic And Resin
- EMC : Conducted And Radiated Emissions Conform To EN55014 CLASS B, EN55032 CLASS B And FCC Part 15
- Immunity Conform To:
EN61000-3-2 CLASS A, EN61000-3-3, IEC61000-4-2, IEC61000-4-3, IEC61000-4-4, IEC61000-4-5, IEC61000-4-6, IEC61000-4-11

Part Number	Output Power (W)	Output Voltage (Vdc)	Output Current (mA)	Output Load Regulation (%)	Max.Operating Ambient (°C)	Min. Part Efficiency (%)
47261	50	5	10000	± 5	50	82
47262	60	9	6600	± 3		85
47263		12	5000			
47264		15	4000			
47265		18	3300			
47266		24	2500			



4 pins
pins 1 & 5 : AC or DC Input
pin 7 : DC output +V
pin 9 : DC output 0V

DIMENSIONS and PINOUT

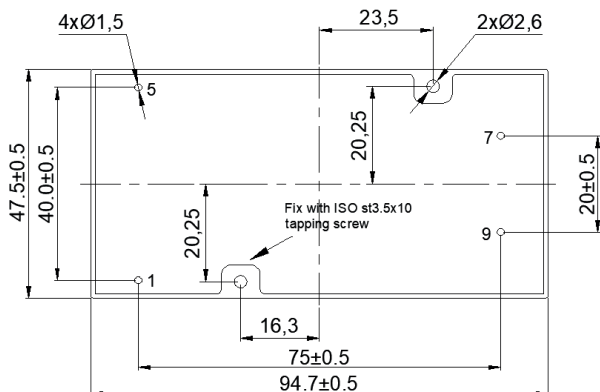

View From Pins Side

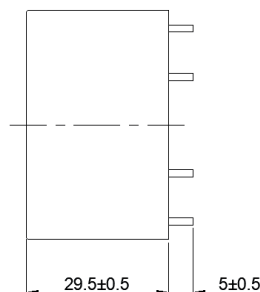

@ pending certification

Model: 60 Watt		Specification
AC Input Characteristics	Rated input Voltage	100~240Vac Or 140VDC-340VDC
	Input Voltage Range	85~265Vac Or 120VDC-370VDC
	AC Input Frequency Range	47Hz~63Hz
	Rated AC Input Frequency	50/60Hz
	Input Current	1.5A Max@85Vac~265Vac, at full load
	Standby Power	0.15W Max (Meet Requirements Of Energy Star And EC Code Of Conduct)
DC Output Characteristics	Output Voltage Accuracy	± 3% (9V, 12V, 15V, 18V, 24V Types) ± 5% (5V Type)
	Output Voltage Line Regulation	± 3% (9V, 12V, 15V, 18V, 24V Types) ± 5% (5V Types)
	Output Voltage Load Regulation	± 3%(9V,12V,15V,18V,24V Types) ± 5% (5V Type)
	Ripple & Noise	Max 200mVp-p @Rated AC input (The measuring will be terminated with a 47uF AL E-Cap and a 0.1uF Cer-Cap. An oscilloscope set at 20MHz bandwidth)
	Efficiency	See table (Meet Requirements Of Energy Star And EC Code Of Conduct)
Protection Characteristics	Over Current Protection	The power supply shall automatic protection. The power supply shall auto-recovery normal operation after the deformation is removed. No excessive heat, odor, or plastic deformation shall occur, no safety hazard
	Output Short Circuit Protection	The power supply shall withstand a continuous output short without damage in 24 hours ; The short may be applied before power on, or after power on; The power supply shall resume normal operation after the short is removed, no excessive heat, odor, or plastic deformation shall occur, no safety hazard
Environmental	Operation Temperature	-25°C ~ + 50°C (see derating curve)
	Operation Humidity	10~ 90% RH (Non Condensing) @ full load
	Storage Temperature	-40°C~ +85°C
	Storage Humidity	5%~95%
Safety & EMC Requirement	Dielectric Strength	Primary to Secondary : 4000Vac 5mA, 3 sec.
	Radiation	Meeting EN55032, EN55014, FCC part 15, Class B. under 3dB margin
	Conduction	Meeting EN55032, EN55014, FCC part 15, Class B. under 3dB margin
	Safety Standards	Meet all requirements of : UL/CUL62368 - IEC/EN60335 - IEC/EN61558-2-16 - IEC/EN62368
Reliability Requirement	MTBF	Calculated by MIL-HDBK-217-F2 200K Hours minimum @230VAC input, 50deg.C
	Burn-In Test	The unit shall be burned in for 2~ 5hours under 230Vac input and DC with full load at an ambient temperature of 30~45 degrees C
	Net Weight	(TBA)
Guarantee	This product meet to RoHS standard	

we reserve the right to change specifications in this document without notice

Application notes for 47000 & 48000 Series

1 – Storage Guide:

Storage temperature : -40°C to +85°C, Storage humidity : 5% to 95%

2 – Shelf life Guide :

To ensure best power supply reliability and life, we would recommend clients to keep the shelf life less than 6 months.

If the power supply is not used or is kept in stock more than 12 months, it is recommended that the Power Supply should be subject to a 2 hour burn-in process.

3- Safety and recommend wiring : linewidth A≥2mm, B≥5mm.

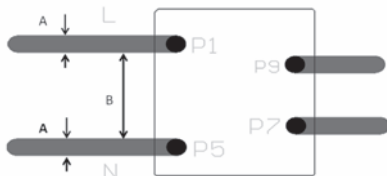

4- Recommended circuit for applications requiring higher EMC performance :

The 47/48 series are already certified as compliant to EN55022 and EN55014 CLASS B for emc. For this compliance no additional external components are required. Should a more stringent emc performance be required the circuit below can be proposed

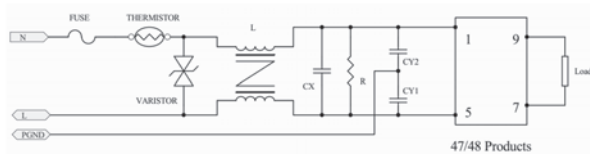

Fuse: recommended parameters : 5A to 10A/250Vac, Time-lag type.
THERMISTOR: recommended parameters : 2A, 5Ω, 1.8W to 5A D10, 2.5Ω, 2.4W.
Varistor: recommended parameters : 14D471, 300Vac, maximum energy 118 Joule.
L is a common mode inductor : recommended parameters : 10mH to 30mH
CX is a X2 capacitor : recommended parameters : 0.1uF to 0.22uF/275Vac
CY1 and CY2 are Y capacitors : recommended parameters : 1000pF to 2200pF/400V
R is a resistor : recommended parameters: 1.0MΩ to 3.0 MΩ.

5 – Application of the connection to ground :

This application is not supported for 47 / 48 products

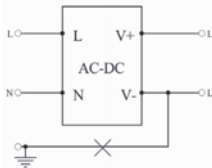

The following proposed circuit may assist :

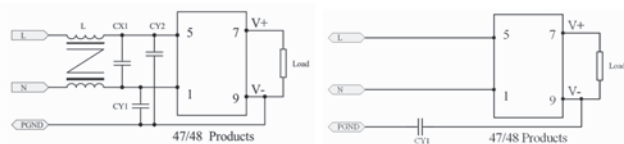

L : is a common mode inductor, the recommended parameters: 10mH to 30mH

CX1 : is an X2 capacitor, the recommended parameters : 0.1uF to 0.22uF/275Vac

CY1 and CY2 are Y capacitors, the recommended parameters : 1000pF to 2200pF/400V

6 – High surge circuit :

The 47 / 48 Series is tested and certified for a surge level in accordance with IEC61000-4-5 as standard without requiring any additional external components. To extend the surge level to 6KV the external circuit below can be proposed.

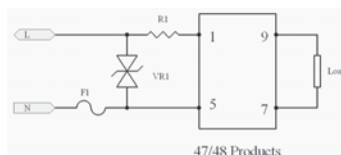

VR1 is a varistor, the recommended parameters : 14D471, 300Vac, maximum energy 118 Joule.

R1 is a wire-wound resistor, the recommended parameters : 10R/1W to 10R/3W, resistance wire Φ0.1 to

0.23mm. **F1** is a fuse, the recommended parameters : 6.3A to 10A/250Vac, Time-lag type.

The information contained in this document is subject to change without notice.

Modified and Custom Solutions

TECHNICAL SERVICES :

- Alternative DC Output Voltages
- Single, Dual or Triple Output Voltages
- Addition of Signal Pins for AC OK, Remote on/off, sense etc.
- Alternative Power Rating
- Revised 'Hold-up' timing to suit System needs
- Customer specific product 'Branding/Labelling'
- Specific Power Supply Manufacturing Functional Test Profile
- Integrating the Power Supply on the System PCB
- Alternative Power Supply Housing
- Revised DC Output Filtering

CUSTOMER SERVICES :

- Existing Designs for Modified Standards
- Flexible Manufacturing Batch Sizes
- European Stock-holding locations
- European Engineering and Logistics Support
- Country Specific Distribution Partners
- Manufacturing dynamics for Volume Fluctuations
- Myrra Quality Controlled Design and Manufacturing
- Fast Sample Service

Contact us for your Power Needs powersupply@myrra.com



A Reliable Brand for your Application



www.myrra.com

***MYRRA SAS
2 Bd de la Haye
Parc Gustave Eiffel
77600 Bussy St Georges
France***

***MYRRA Deutschland GmbH
Marie-Curie-Straße 4/1
71083 Herrenberg
Germany***

powersupply@myrra.com

X-ON Electronics

Largest Supplier of Electrical and Electronic Components

Click to view similar products for [Modular Power Supplies](#) category:

Click to view products by [Myrra](#) manufacturer:

Other Similar products are found below :

[73-147-000](#) [73-270-000](#) [73-316-4020](#) [73-317-0005](#) [73-495-0333](#) [73-961-4086-G2](#) [GLD150-48-103-G](#) [PS3E-B12F](#) [PS3E-E12F](#) [AS300-MLF](#)
[OVS-12E](#) [OVS-12F](#) [OVS-12J](#) [OVS-15F](#) [OVS-15J](#) [IVS13Q2Q1F4LL030ANJCUNR32](#) [LB115S48KH](#) [FP2-PSA1](#) [PS3E-F12F](#) [IMP4-3O1-](#)
[2J1-05-B-662](#) [UPS40-3003](#) [LB240S48KH](#) [LMM409](#) [CHASSIS](#) [LPM615-CHAS](#) [ADNB008-48-1PM-C](#) [ADNB017-24-1PM-C](#) [ADNB040-24-](#)
[1PM-C](#) [VAS003ZG](#) [ADNB050-12-1PM-C](#) [ADNB040-15-1PM-C](#) [ADNB034-12-1PM-C](#) [73-166-000](#) [73-271-000](#) [73-961-4085-G2](#) [73-962-](#)
[0001](#) [OVS-15G](#) [1-155777G](#) [OVS-24F](#) [OVS-5F](#) [73-551-5086](#) [73-554-4047](#) [73-670-0001I](#) [73-713-001](#) [73-769-003](#) [73-954-0001C-G2](#) [73-](#)
[951-0001S-G2](#) [73-560-434](#) [73-180-0001I](#) [73-554-4045](#) [73-956-0001S-G2](#)