

INFORMATION

NEC/TOKIN

**MINIATURE SIGNAL RELAYS
EA2 SERIES
TECHNICAL DATA**

INFORMATION

NEC/TOKIN

MINIATURE SIGNAL RELAYS
EA2 SERIES
TECHNICAL DATA

No part of this document may be copied or reproduced in any form or by any means without the prior written consent of NEC/TOKIN Corporation. NEC/TOKIN Corporation assumes no responsibility for any errors which may appear in this document.

NEC/TOKIN Corporation does not assume any liability for infringement of patents, copyrights or other intellectual property rights of third parties by or arising from use of a device described herein or any other liability arising from use of such device. No license, either express, implied or otherwise, is granted under any patents, copyrights or other intellectual property rights of NEC /TOKIN Corporation or others.

While NEC/TOKIN Corporation has been making continuous effort to enhance the reliability of its electronic components, the possibility of defects cannot be eliminated entirely. To minimize risks of damage or injury to persons or property arising from a defect in an NEC/TOKIN electronic component, customers must incorporate sufficient safety measures in its design, such as redundancy, fire-containment, and anti-failure features. NEC/TOKIN devices are classified into the following three quality grades:

"Standard," "Special," and "Specific". The Specific quality grade applies only to devices developed based on a customer designated "quality assurance program" for a specific application. The recommended applications of a device depend on its quality grade, as indicated below. Customers must check the quality grade of each device before using it in a particular application.

Standard: Computers, office equipment, communications equipment, test and measurement equipment, audio and visual equipment, home electronic appliances, machine tools, personal electronic equipment and industrial robots

Special: Transportation equipment (automobiles, trains, ships, etc.), traffic control systems, anti-disaster systems, anti-crime systems, safety equipment and medical equipment (not specifically designed for life support)

Specific: Aircrafts, aerospace equipment, submersible repeaters, nuclear reactor control systems, life support systems or medical equipment for life support, etc.

The quality grade of NEC/TOKIN devices is "Standard" unless otherwise specified in NEC/TOKIN's Data Sheets or Data Books. If customers intend to use NEC/TOKIN devices for applications other than those specified for Standard quality grade, they should contact an NEC/TOKIN sales representative in advance.

(Note)

- (1) "NEC/TOKIN" as used in this statement means NEC/TOKIN Corporation and also includes its majority-owned subsidiaries.
- (2) "NEC/TOKIN electronic component products" means any electronic component product developed or manufactured by or for NEC/TOKIN (as defined above).

CONTENTS

1. Preface	1
2. Structure	2
3. Basic Characteristics	3
3.1 Switching power	3
3.2 Life curve	3
3.3 Maximum coil voltage	4
3.4 Coil temperature rise	4
3.5 Driving power vs. timing	5
3.6 Driving pulse width vs. set & reset voltages	6
3.7 Thermal characteristics	7
3.8 Magnetic interference	8
3.9 High-frequency characteristics	9
3.10 Coil inductance	10
3.10.1 Measurement by LCR meter	10
3.10.2 Measurement by coil current waveform	10
3.11 Capacitance	11
3.12 Resistance to surge voltage	12
3.13 Resistance to surge current	12
3.14 Resistance to carrying current	13
4. Distribution of Characteristics	14
4.1 Operate & release voltages (set & reset voltages)	14
4.2 Operate & release times (set & reset times)	15
4.3 Transfer time	16
4.4 Timing and details	17
4.5 Contact resistance	21
4.6 Breakdown voltage	22
4.7 Thermal EMF (offset voltage between contacts)	22
5. Test Data	23
5.1 Environmental tests	24
5.1.1 High-temperature test	24
5.1.2 Low-temperature test	26
5.1.3 Moisture resistance test	27
5.1.4 Heat shock test	28
5.1.5 Vibration test	29
5.1.6 Shock test	30
5.1.7 Resistance to solder heat test	31
5.1.8 Terminal strength test	32

5.2	Contact life tests	33
5.2.1	Non-load test A (Mechanical life test, $T_a = 25^\circ\text{C}$)	33
5.2.2	Non-load test B (Mechanical life test, $T_a = 85^\circ\text{C}$)	34
5.2.3	Resistive load test A (10 m Vdc, 10 μA , $T_a = 25^\circ\text{C}$)	34
5.2.4	Resistive load test B (10 Vdc, 10 mA, $T_a = 85^\circ\text{C}$)	35
5.2.5	Resistive load test C (28 Vdc, 100 mA, $T_a = 85^\circ\text{C}$)	35
5.2.6	Resistive load test D (50 Vdc, 100 mA, $T_a = 25^\circ\text{C}$)	36
5.2.7	Resistive load test E (50 Vdc, 100 mA, $T_a = 85^\circ\text{C}$)	36
5.2.8	Inductive load test (48 Vdc, 110 mA, $T_a = 25^\circ\text{C}$)	37
5.2.9	Resistive load test F (220 Vdc, 0.14 A, $T_a = 25^\circ\text{C}$)	37
5.2.10	Resistive load test G (125 Vdc, 0.5 A, $T_a = 25^\circ\text{C}$)	38
5.2.11	Resistive load test H (30 Vdc, 1 A, $T_a = 25^\circ\text{C}$)	38

1. Preface

Miniature signal relays are used in a wide range of application fields including communication, measurement, and factory automation. This document gives the basic characteristics and test data of NEC's EA2 series miniature signal relays.

- Notes**
1. The symbol \top shown in the graphs throughout this document indicates the maximum value of the data. Likewise, \perp indicates the minimum value, and \blacklozenge indicates the mean value.
 2. When a relay is driven by an IC, a protective element such as a diode may be connected in parallel with the relay coil to protect the IC from damage caused by the counter-electromotive force (EMF) due to the inductance of the coil. However, unless otherwise specified, the operate time and release time (set and reset times) shown in this document are measured without such a protective element.

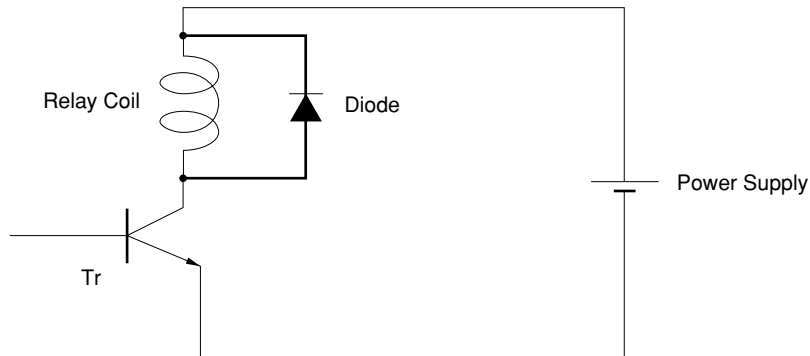

For Right Use of Miniature Relays

DO NOT EXCEED MAXIMUM RATINGS.

Do not use relays under exceeding conditions such as over ambient temperature, over voltage and over current. Incorrect use could result in abnormal heating, damage to related parts or cause burning.

READ CAUTIONS IN THE SELECTION GUIDE.

Read the cautions described in NEC/TOKIN's "Miniature Relays" (0123EMDD03VOL01E) when you choose relays for your application.

2. Structure

Figure 2.1 shows the structure of the EA2 series relay that has a terminal configuration called dual in-line leads (DIL). Table 2.1 lists the parts constituting the relay.

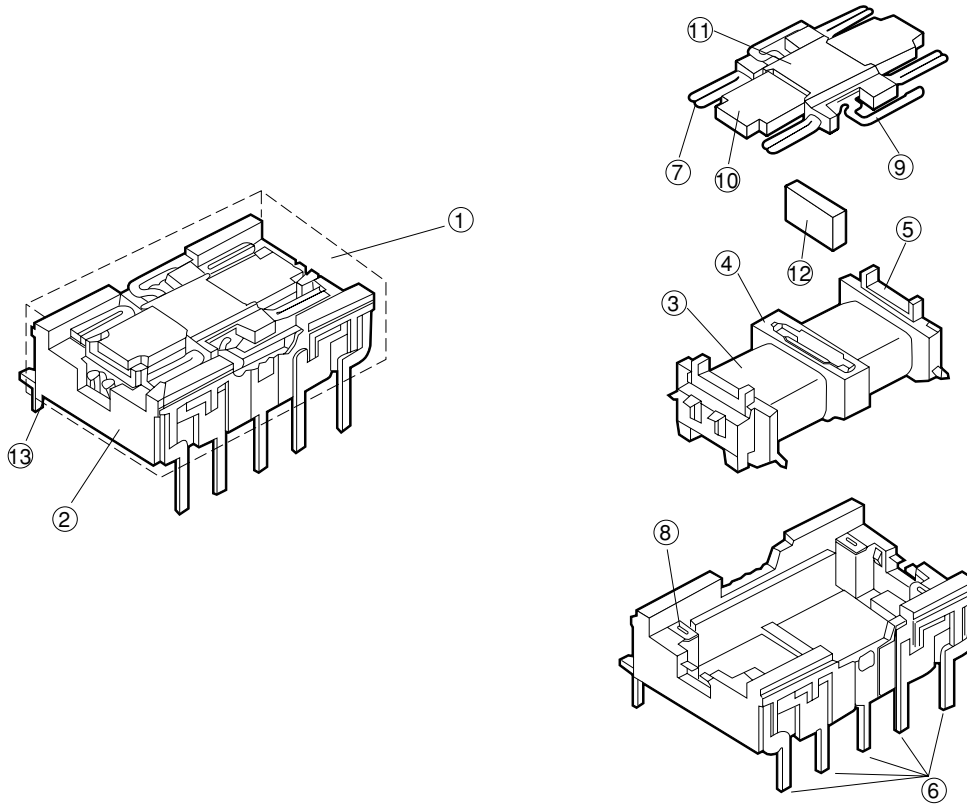

Figure 2.1 Structure of the EA2 Series Relay

Table 2.1 Parts of EA2 Series Relay

No.	Parts	Material
1	Cover	Polybutylene telephthalate [#]
2	Base	Liquid crystalline polymer [#]
3	Coil wire	Polyurethane copper wire
4	Coil spool	Polyphenylene sulfide [#]
5	Core	Pure iron
6	Terminal	Phosphor bronze (surface is treated with preparatory solder)
7	Moving contact	Au-alloy + AgNi [*]
8	Stationary contact	Au-alloy + AgNi [*]
9	Contact spring	Phosphor bronze
10	Armature	Pure iron
11	Armature block mold	Polyether sulfone [#]
12	Magnet	Cobalt magnet
13	Sealing material	Epoxy resin

Note: *: Standard type

#: Conforms to UL94V-0

3. Basic Characteristics

This section provides data necessary for designing an external circuit that uses the relay.

3.1 Switching power

If the contact load voltage and current of the relay are in the region enclosed by the solid and dotted lines in the figure below, the relay can perform stable switching operation. If the relay is used at a voltage or current exceeding this region, the life of the contacts may be significantly shortened.

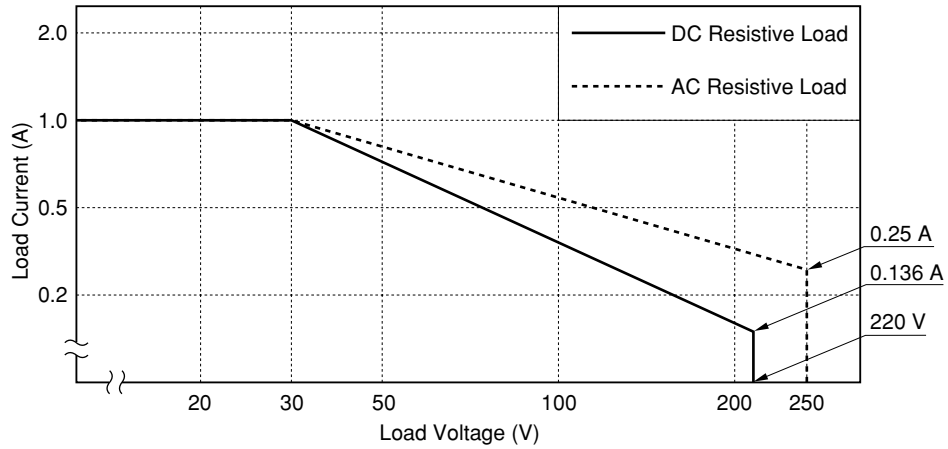

Figure 3.1 Switching Power

3.2 Life curve

The life expectancy of the relay can be roughly estimated from the switching voltage and current of the contact load shown in Figure 3.2.

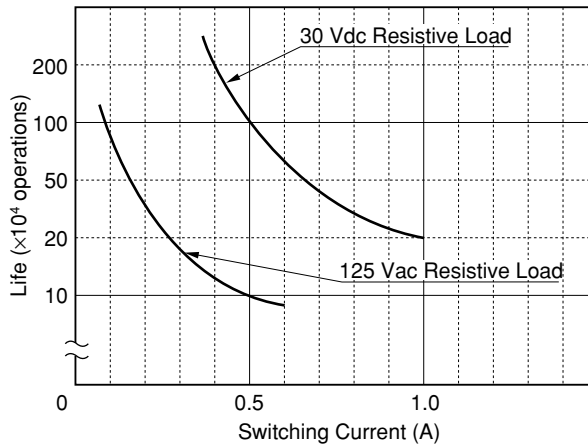

Figure 3.2 Life Curve

3.3 Maximum coil voltage

Figure 3.3 shows the ratio of maximum voltage that can be continuously applied to the coil of the relay to the nominal voltage. As long as the relay is used in the enclosed region in this figure, the coil is not damaged due to burning and the coil temperature does not rise to an abnormally high level.

(* Rated Coil Voltage: 3 to 24 Vdc)

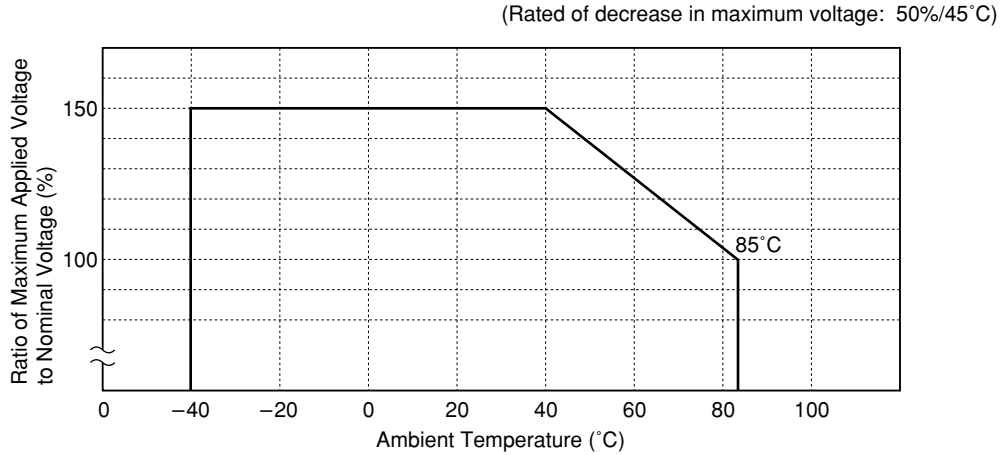

Figure 3.3 Maximum Voltage Applied to Coil

3.4 Coil temperature rise

Figure 3.4 shows the relation between the rise in coil temperature and the power (product of the coil voltage and current) dissipated by the coil. This figure shows the difference between the temperature before the power is applied to the coil and the saturated temperature after application of power to the coil.

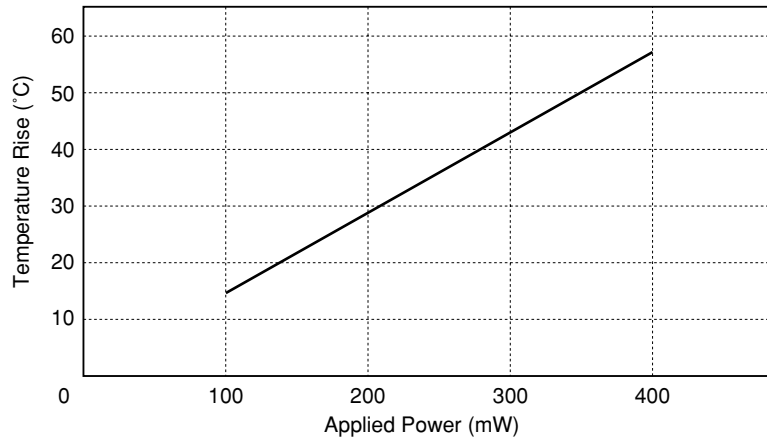
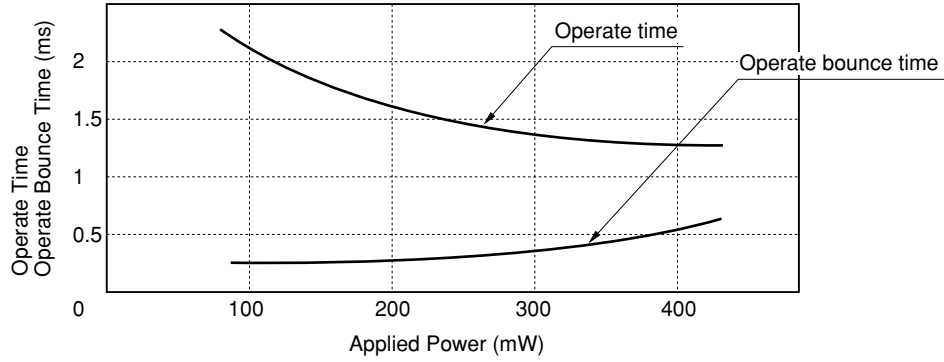

Figure 3.4 Coil Temperature Rise

3.5 Driving power vs. timing

Figure 3.5 (1) shows the relations among the power applied to drive the relay, the operate time, and the bounce time. Figure 3.5 (2) shows the relations among the supplied power, the release time, and the bounce time, and Figure 3.5 (3) shows the relations among the supplied power, the release time, and the bounce time when a diode is connected to the coil to absorb surges.

(1) Operate time



(2) Release time

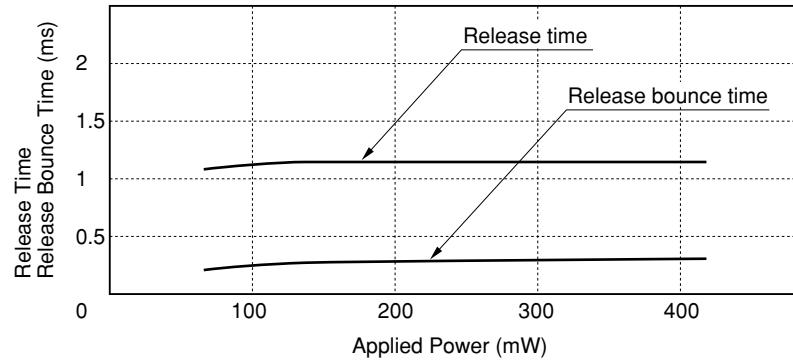

(3) Release time (with diode)

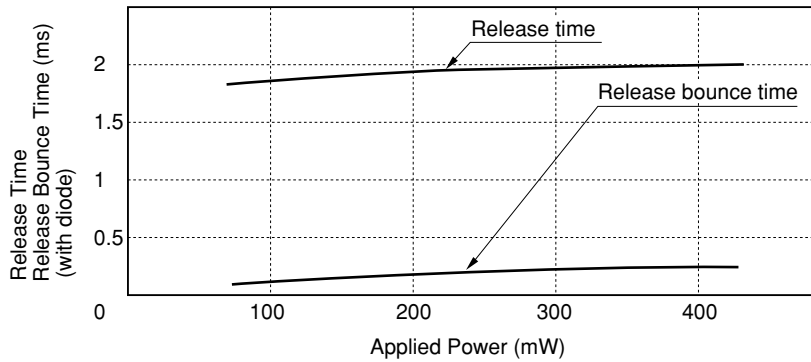

Figure 3.5 Driving Power vs. Timing

3.6 Driving pulse width vs. set & reset voltages

Because the latching type relay can be driven on a pulse voltage, it can save power. However, if the pulse width is too narrow, the relay does not operate correctly.

Figure 3.6 shows the relations among the width of the pulse voltage applied to the coil, the set voltage, and the reset voltage of the latching type relay.

(1) Set voltage

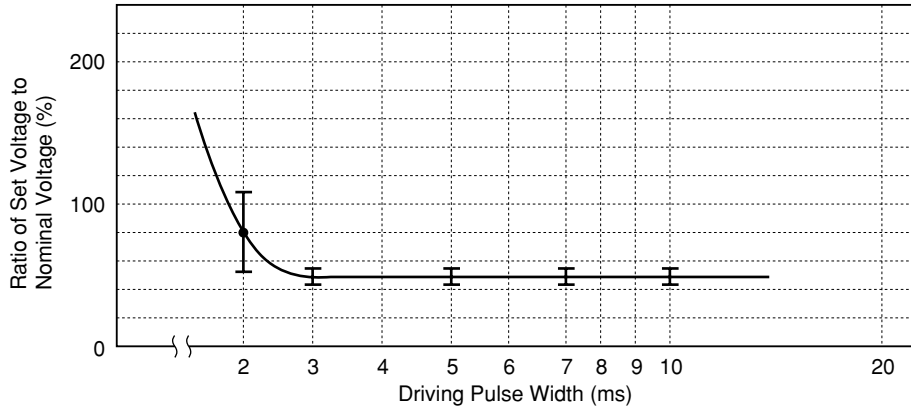

(2) Reset voltage

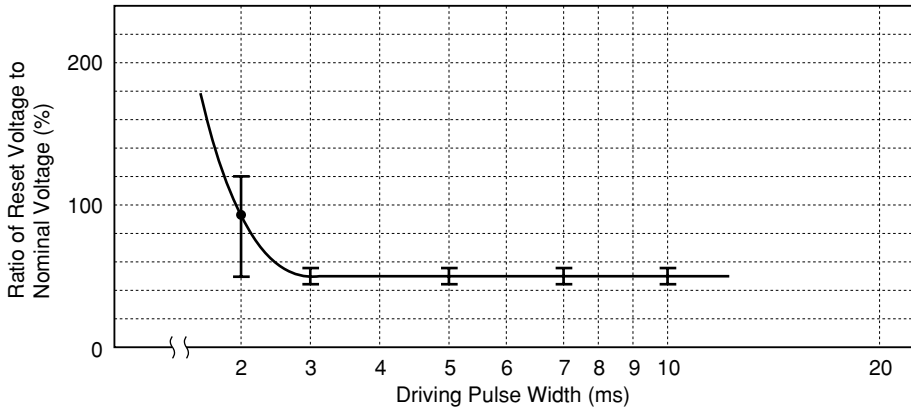

Figure 3.6 Driving Pulse Width vs. Set & Reset Voltages

(Hints on correct use)

If the driving pulse width is too narrow, the relay cannot be driven at the nominal voltage. Hence, in actual applications, apply a pulse with a width of 10 ms or more to the relay.

3.7 Thermal characteristics

The general characteristics of a relay gradually change with the ambient temperature. Figure 3.7 shows the typical characteristics of the EA2 series relay.

(1) Operate & release voltages

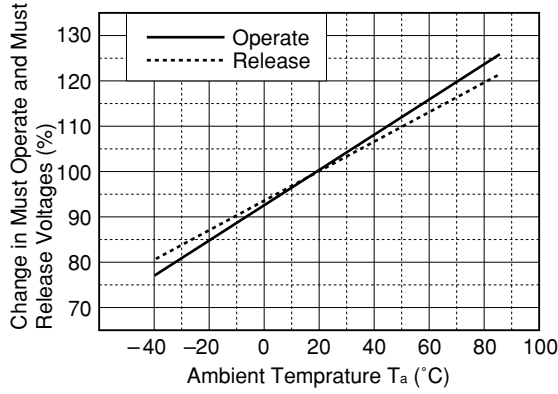

(2) Contact resistance*

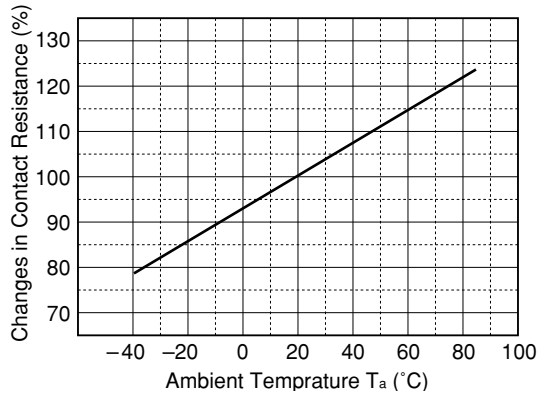

(4) Transfer time

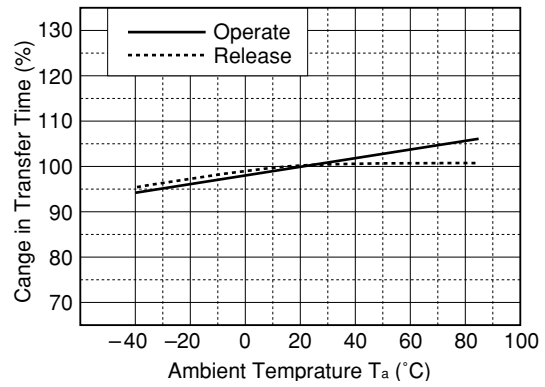

(3) Operate & release times

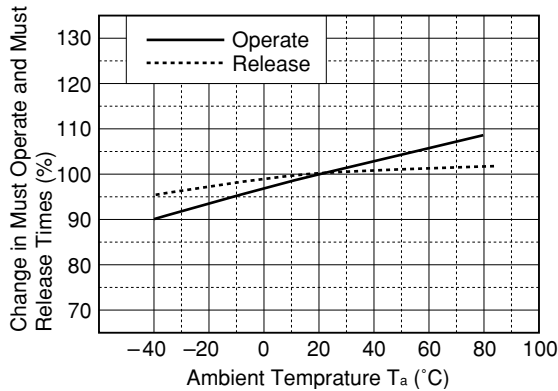

(5) Coil resistance

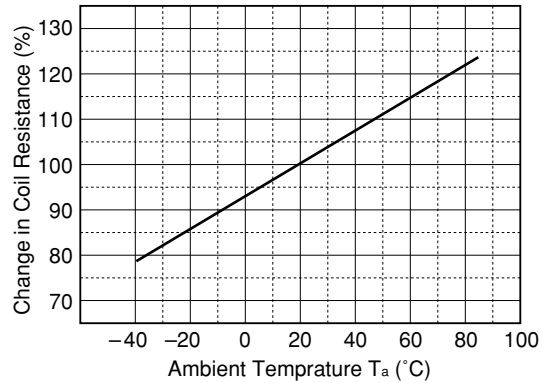

Figure 3.7 Temperature Characteristics

* The contact resistance includes the conductive resistance of the terminals. It is this conductive resistance component that changes with the temperature.

3.8 Magnetic interference

This section describes changes in the operate voltage caused by mutual magnetic interference when several relays are closely mounted on a printed circuit board (PCB). Figure 3.8 (1) shows the distance among the relays mounted on the PCB. As shown, the pin pitch of each relay is 2.54 mm. Figure 3.8 (2) shows the relay that is subject to interference. In this figure, the hatched relay shown in the center of each relay arrangement is subject to interference, and the surrounding relays influence the center relay. The condition under which the center relay suffers interference and the surrounding relays affect the center relay differs depending on whether power is supplied to each relay. Figure 3.8 (3) shows the deviation in percent of the operate and release voltages of the center relays in Figure 3.8 (2).

(1) Mounting pitch (mm)

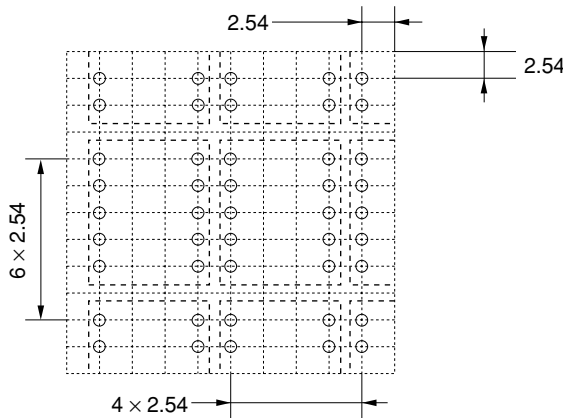

(2) Relay arrangement

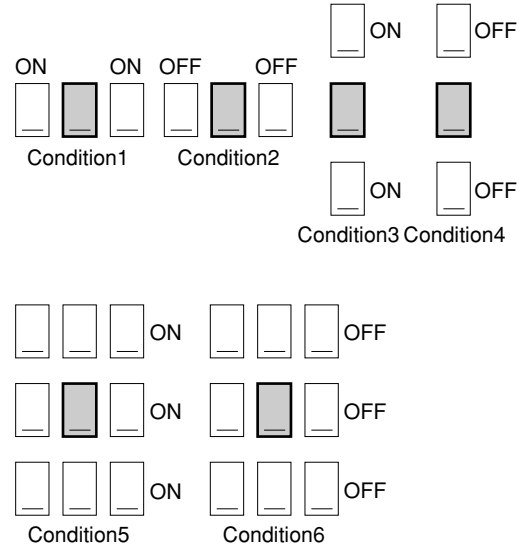

(3) Deviation of must operate and must release voltages

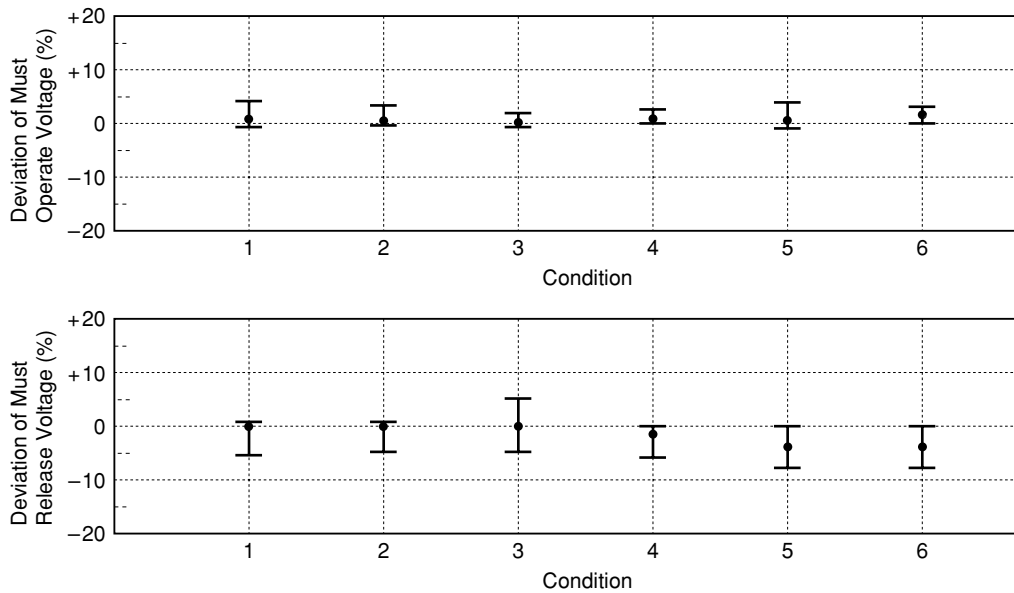

Figure 3.8 Magnetic Interference

3.9 High-frequency characteristics

Figure 3.9 shows the performance of the EA2 series relay when a high-frequency signal is switched by the contacts of the relay. Figure 3.9 (1) shows the test circuit. Figure 3.9 (2) shows the isolation loss of the relay. Figure 3.9 (3) and Figure 3.9 (4) respectively show the insertion loss and return loss.

(1) Test circuit

Test equipment: HP8505A Network Analyzer (characteristic impedance: 50 Ω)

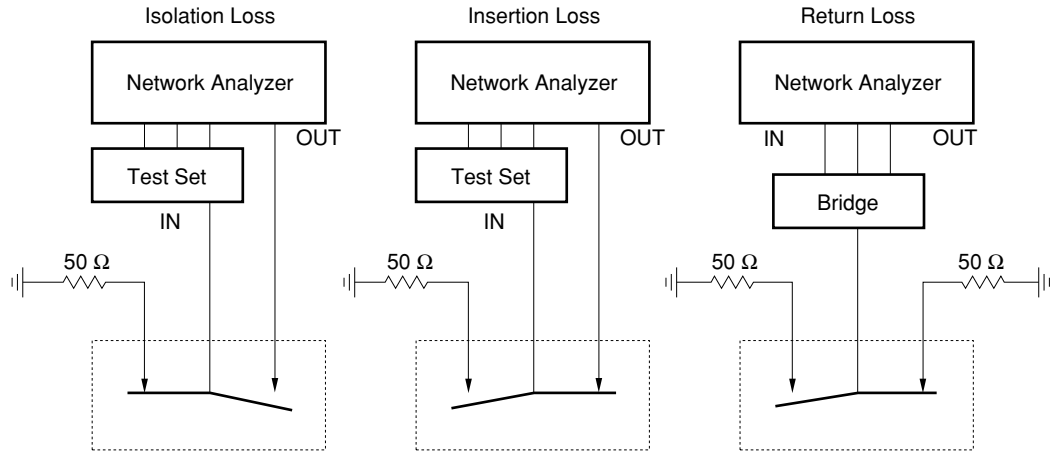

(2) Isolation loss

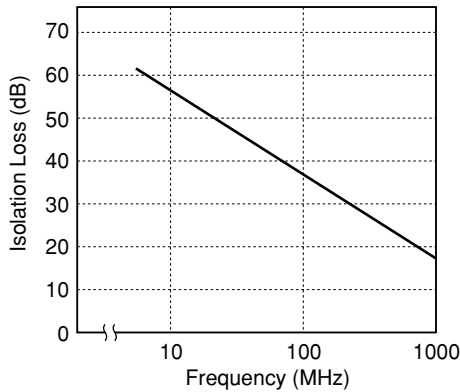

(3) Insertion loss

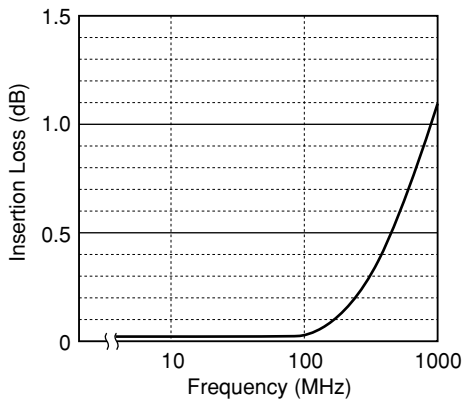

(4) Return loss

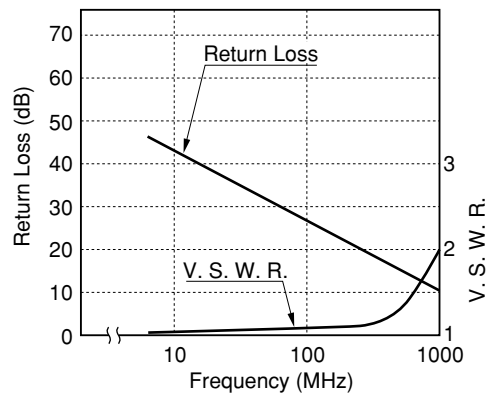

Figure 3.9 High-frequency characteristics

3.10 Coil inductance

The control input of a relay is the coil. The coil inductance can be measured using the following two methods. Either method may be used based on preference. Table 3.1.1 and 3.1.2 show the results of measurement.

3.10.1 Measurement by LCR meter

Table 3.1.1 Coil Inductance

(Unit: mH)

Part Number (Non-latching Type) (Standard type)	Inductance	Part Number (Single Coil Latching Type)	Inductance	Part Number (Double Coil Latching Type)	Inductance
EA2-3	40	EA2-3S	60	EA2-3T	20
EA2-4.5	90	EA2-4.5S	110	EA2-4.5T	45
EA2-5	110	EA2-5S	130	EA2-5T	60
EA2-6	140	EA2-6S	170	EA2-6T	70
EA2-9	300	EA2-9S	380	EA2-9T	140
EA2-12	440	EA2-12S	600	EA2-12T	220
EA2-24	1010	EA2-24S	1500	EA2-24T	510

(Measurement frequency: 1 kHz)

3.10.2 Measurement by coil current waveform

The inductance is calculated by observation of τ equaling 63.2% of maximum value.

τ : Determined by current waveform $I = I_{\max} (1 - e^{-t/\tau})$.

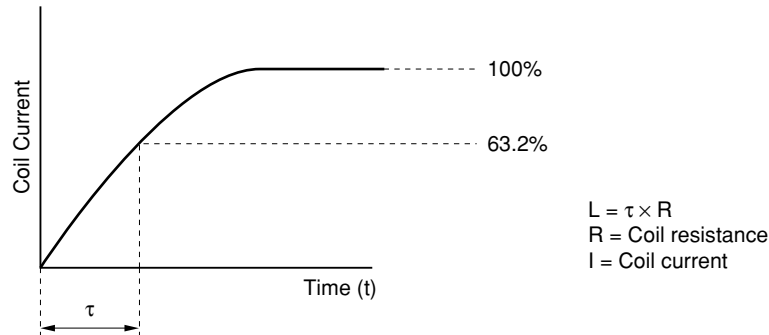

Table 3.1.2 Coil Inductance

(Unit: mH)

Part Number (Non-latching Type) (Standard type)	Inductance	Part Number (Single Coil Latching Type)	Inductance	Part Number (Double Coil Latching Type)	Inductance
EA2-3	14	EA2-3S	33	EA2-3T	8
EA2-4.5	67	EA2-4.5S	67	EA2-4.5T	21
EA2-5	83	EA2-5S	80	EA2-5T	27
EA2-6	122	EA2-6S	113	EA2-6T	38
EA2-9	280	EA2-9S	270	EA2-9T	91
EA2-12	447	EA2-12S	507	EA2-12T	128
EA2-24	1025	EA2-24S	1053	EA2-24T	352

(Applied voltage = Nominal D.C. voltage)

3.11 Capacitance

Table 3.2 shows the capacitance between terminals of the EA2 series relay.

Note that the terminals not tested are left open.

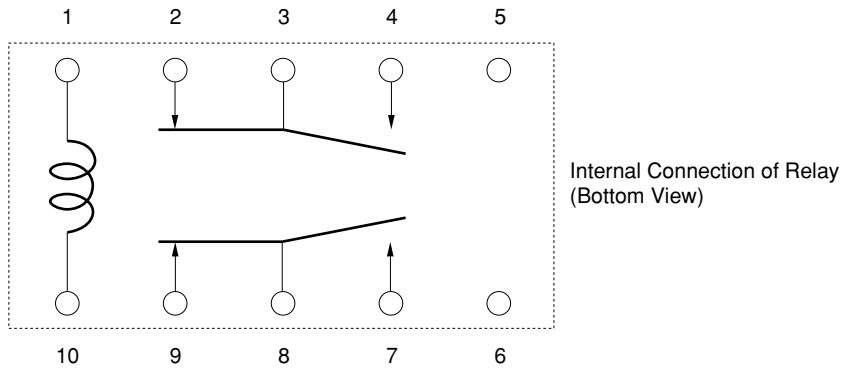

Table 3.2 Capacitance

(Unit: pF)

Parameter	Terminal Number	Capacitance
Between Coil and Contact	1, 3	1.37
	1, 8	1.37
Between Opening Contacts	3, 4	0.58
	7, 8	0.55
Between Adjacent Contacts	3, 7	0.34
	3, 8	0.59
	4, 7	0.25
	4, 8	0.32

3.12 Resistance to surge voltage

When a relay is used in a communication circuit, it may be subjected to a lightning surge via the circuit or due to induction. A surge voltage test is conducted to measure the resistance of the EA2 series relays to surge voltage.

The voltage waveform used for this test is specified by the Federal Communications Commission (FCC) Standard Part 68.

The EA2 series relay can withstand even if the surge voltage shown in Figure 3.10 is applied (1) between opening contacts, (2) between coil and contact, or (3) between adjacent contacts.

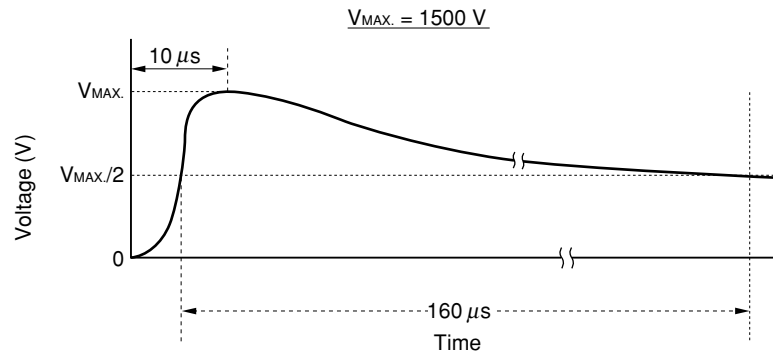

Figure 3.10 Surge Voltage Waveform

3.13 Resistance to surge current

If a lightning surge is applied between the closed contacts, a current whose value is determined by the impedance of the route connected to the contacts may flow. This current may be referred to as a “surge current”, and Figure 3.10 and Table 3.3 show the resistance of the EA2 series relay to the surge current. Figure 3.10 shows the waveform of the applied surge current. Table 3.3 shows the values of the current the relay can withstand. The relay is damaged by burning and malfunctions when a current higher than 220 A is applied to it.

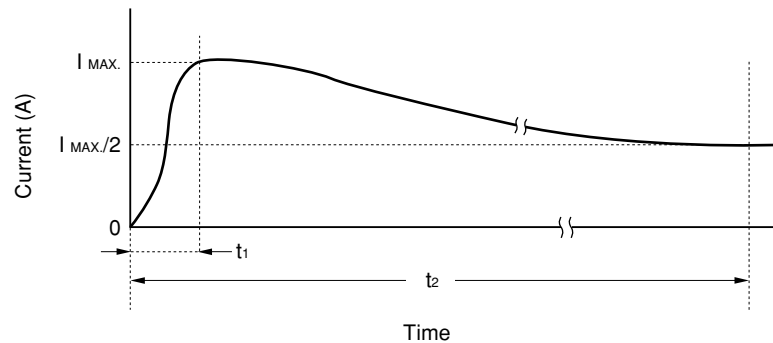

Figure 3.11 Surge Current Waveform

Table 3.3

t1/t2	I MAX.	Result
20/1000 μ s	200 A	Good
	220 A	No good
10/160 μ s	200 A	Good

3.14 Resistance to carrying current

If an abnormally high current flows continuously through the closed contacts of the relay for a long time, meltdown of the contacts or armature block mold of the relay may occur.

Figure 3.12 shows the relation between the value of the carrying current at which the relay can operate normally and time.

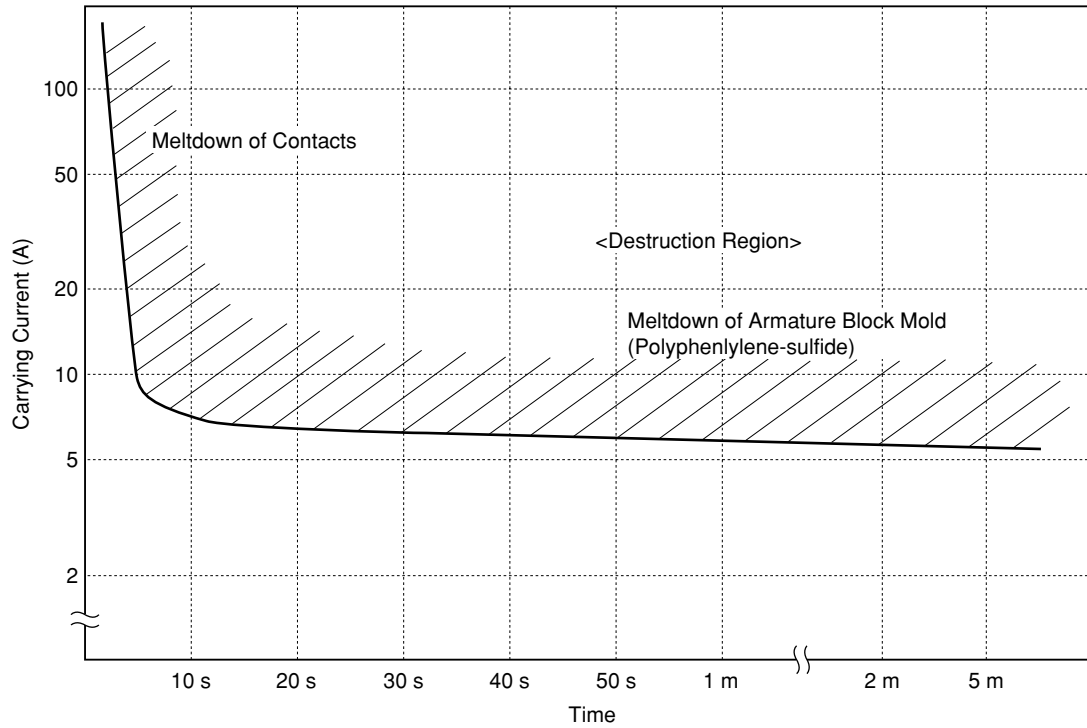

Figure 3.12 Resistance to Carrying Current

(Hints on correct use)

Limit the carrying current of the contacts to a maximum of 1.5 A to maintain the reliability of the relay.

4. Distribution of Characteristics

This chapter presents the distribution data of the general characteristic values of the EA2 series relay. The data shown in this chapter are sampled from a certain production lot, and do not necessarily guarantee the characteristics of any particular lot that is shipped. The number of samples is 40 relays for each test.

4.1 Operate & release voltages (set & reset voltages)

This section shows the distribution of the voltage at which the relay operates.

(1) Non-latching, 5-V type (sample: EA2-5)

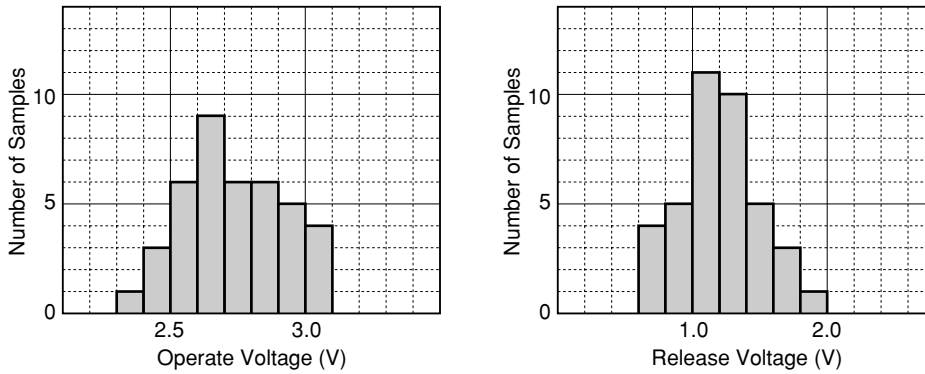

(2) Non-latching, 24-V type (sample: EA2-24)

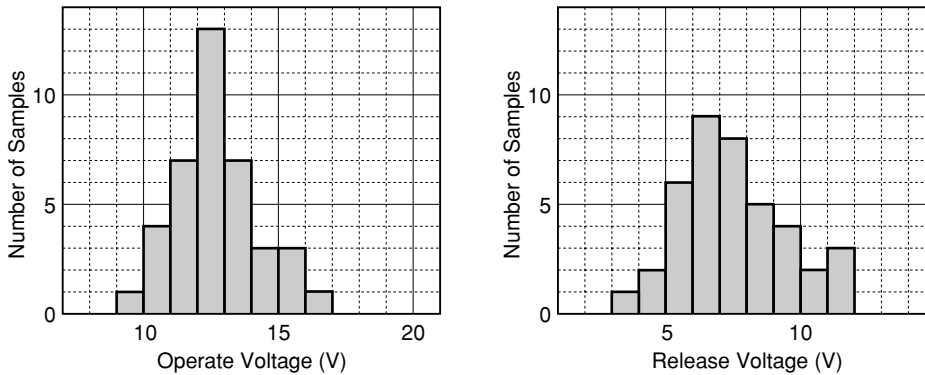

(3) Latching of single-wound coil, 5-V type (sample: EA2-5S)

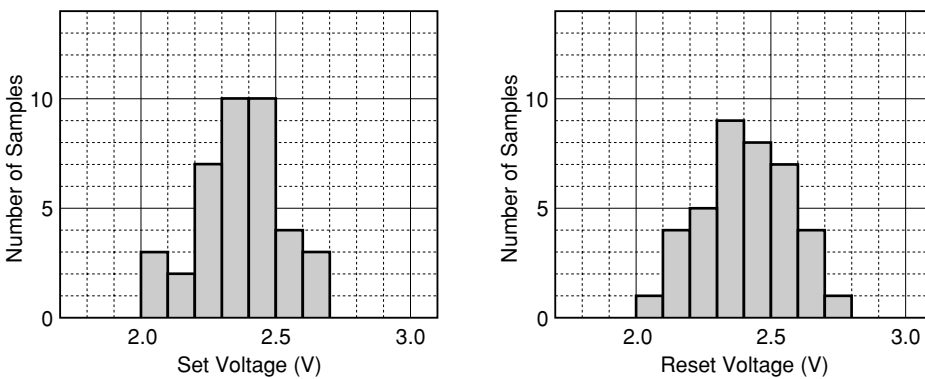

Figure 4.1 Operate & Release Voltages

4.2 Operate & release times (set & reset times)

This section shows the operate time that elapses from the time when the relay coil is energized until the relay contacts close, and the release time that elapses from the time when the relay coil is deenergized until the closed contacts open.

The number of samples used for each measurement is 40.

(1) Non-latching, 5-V type (sample: EA2-5)

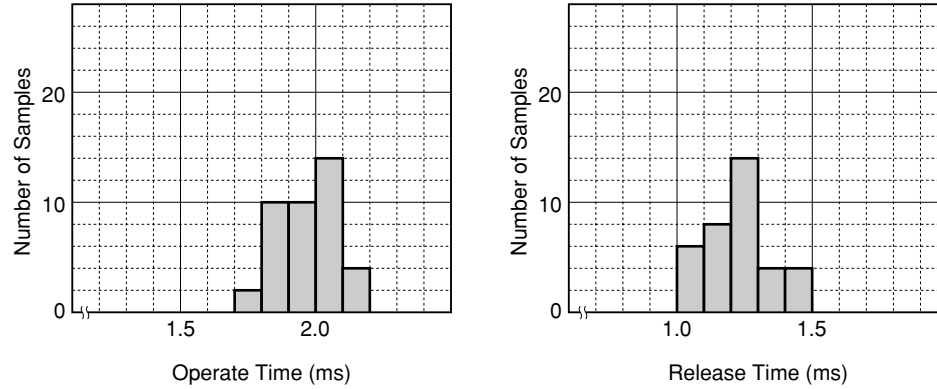

(2) Non-latching, 24-V type (sample: EA2-24)

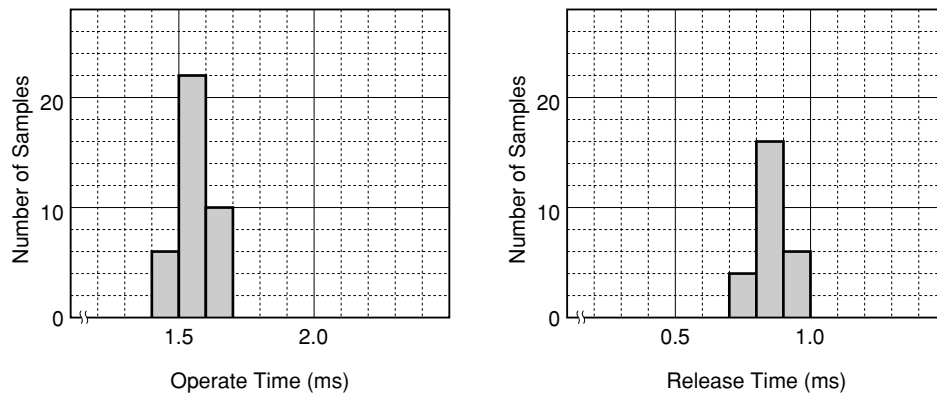

(3) Latching of single-wound coil, 5-V type (sample: EA2-5S)

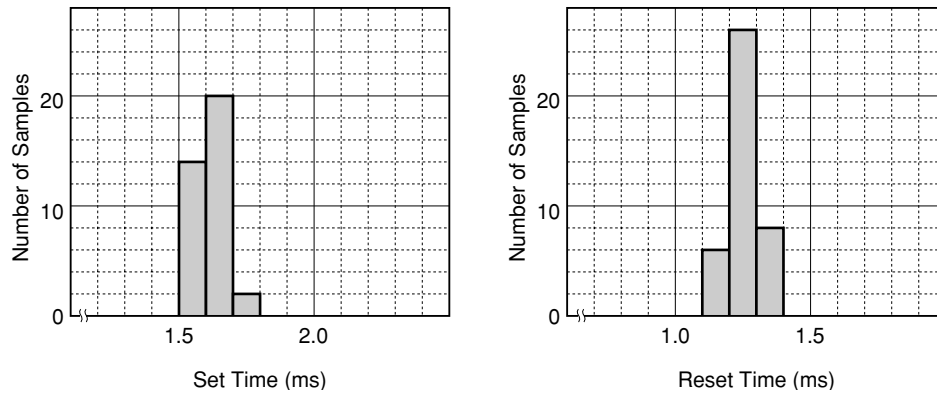
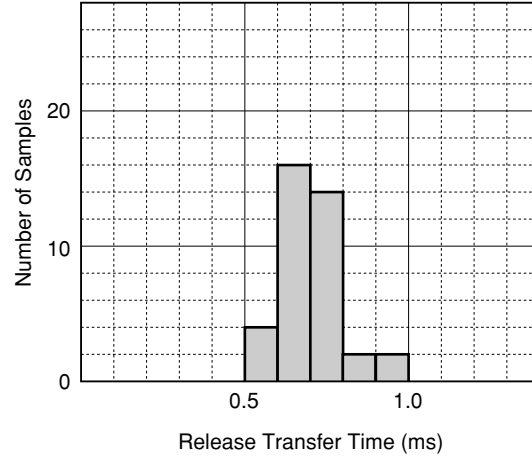
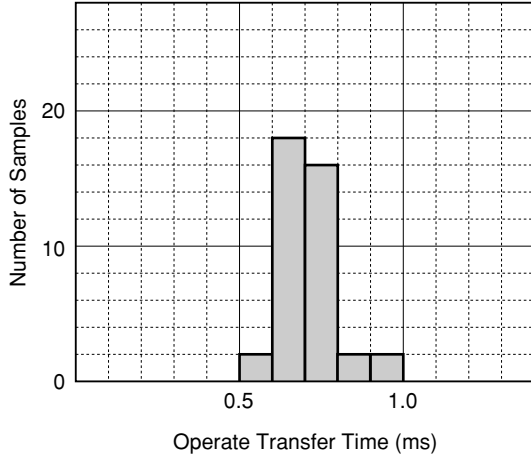

Figure 4.2 Operate & Release Times

4.3 Transfer time

This section gives data on the transfer time, which is the total time between the breaking of one set of contacts and the making of another. The number of samples used for each measurement of the transfer time is 40.

(1) Non-latching, 5-V type (sample: EA2-5)



(2) Non-latching, 24-V type (sample: EA2-24)

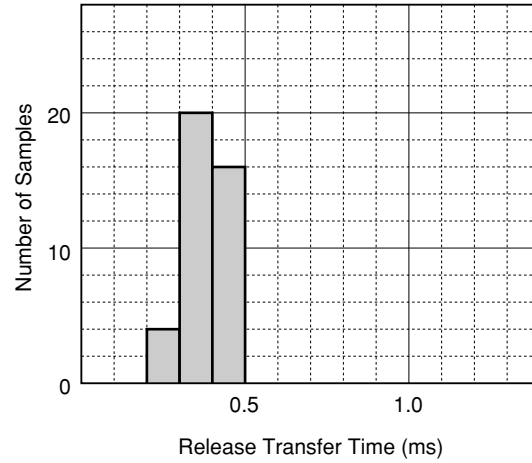
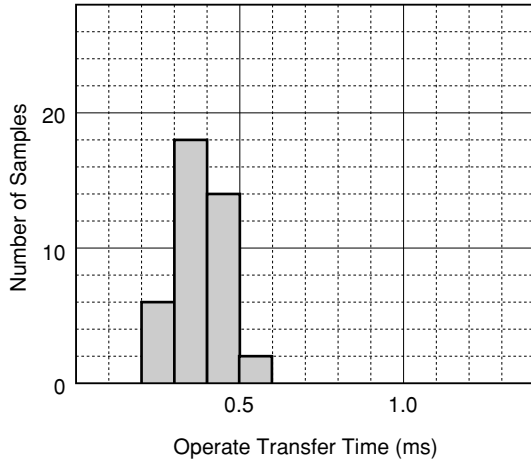

(3) Latching of single-wound coil, 5-V type (sample: EA2-5S)

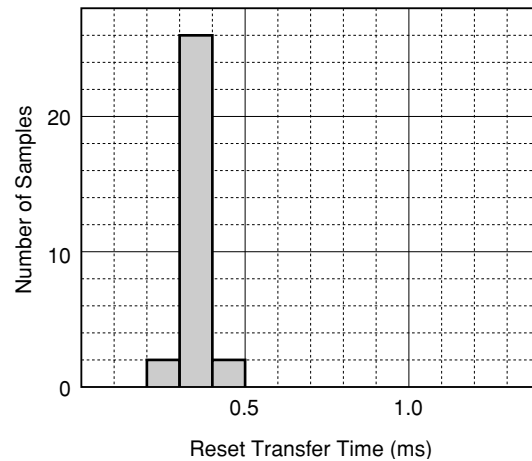
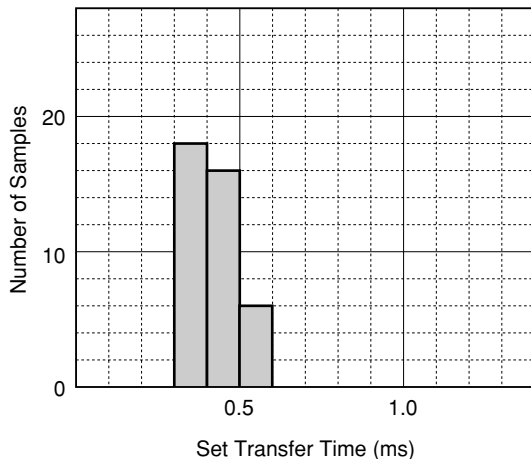

Figure 4.3 Transfer Times

4.4 Timing and details

The EA2 series relays have two sets of transfer contacts. This section shows the movements of each contact, which are not included in the timing specifications, using the timing chart shown in Figure 4.4A.

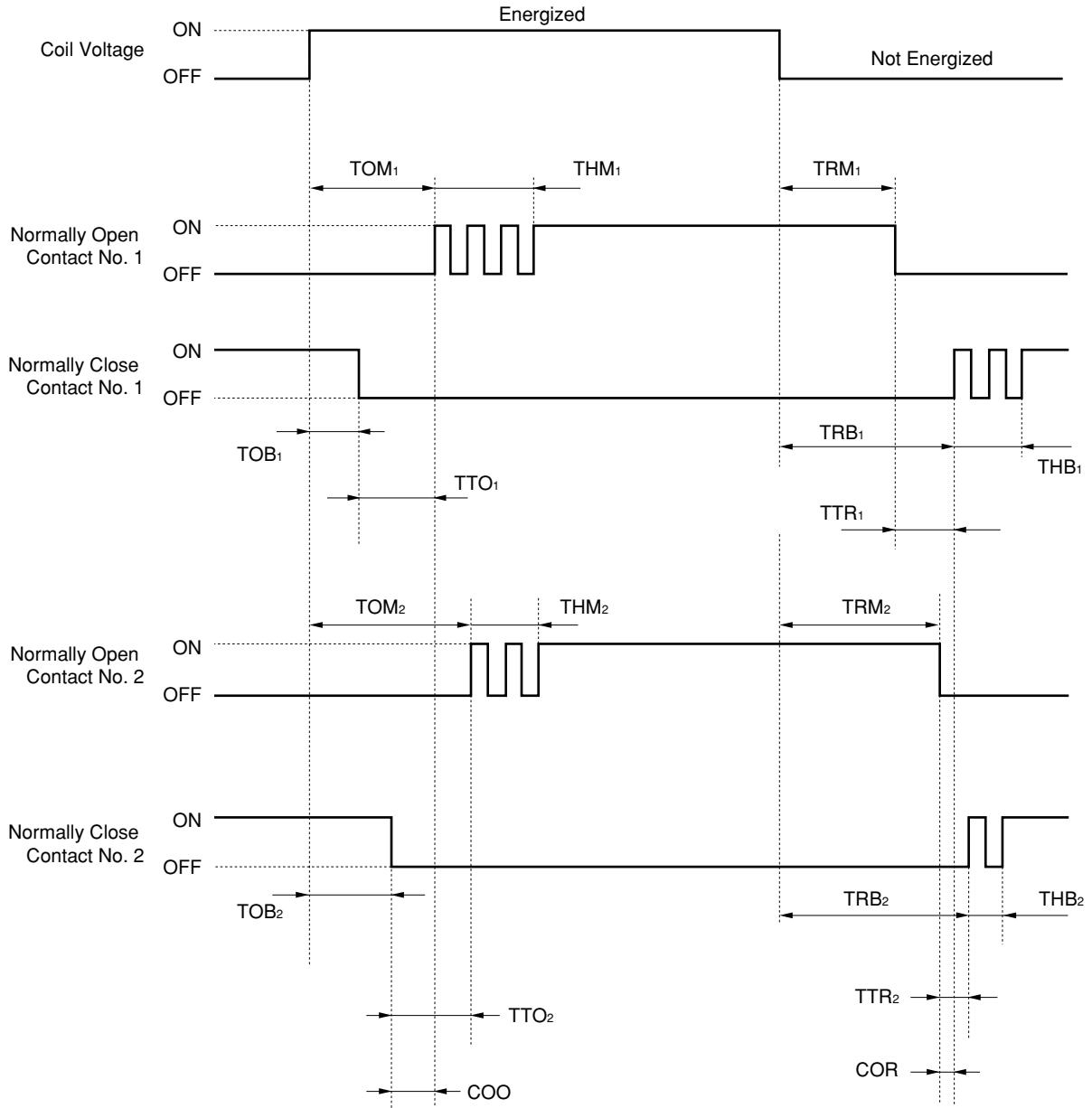

Figure 4.4A Timing Chart of Coil and Contacts

(Test results)

The timing specifications show the greater of the values of the two sets of contacts. The time difference between the two contact sets, however, is almost negligible as shown in data (1) through (8) on the following pages. Practically, therefore, the time difference can be ignored.

The following charts show the distribution of timing. Twenty EA2-5's are used as the samples.

(1) On times of make contacts at operation (TOM)

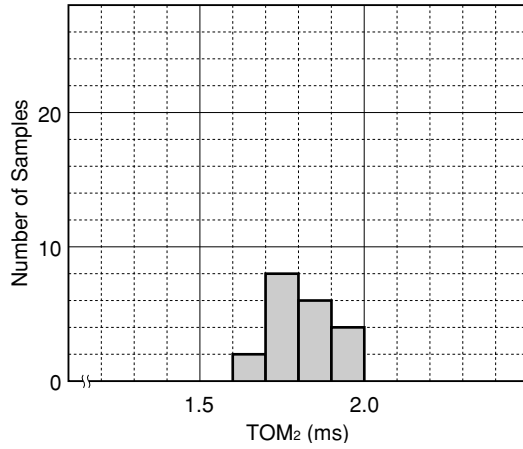
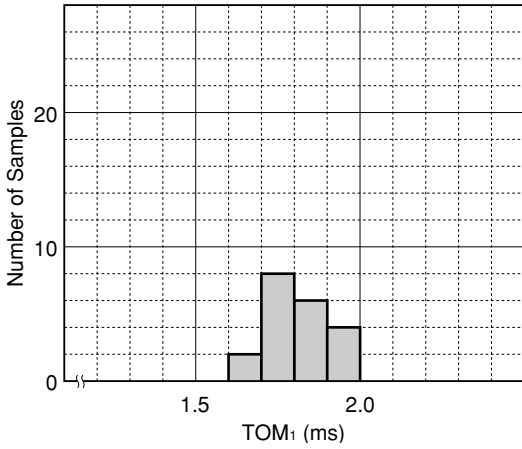

(2) Off times of break contacts at operation (TOB)

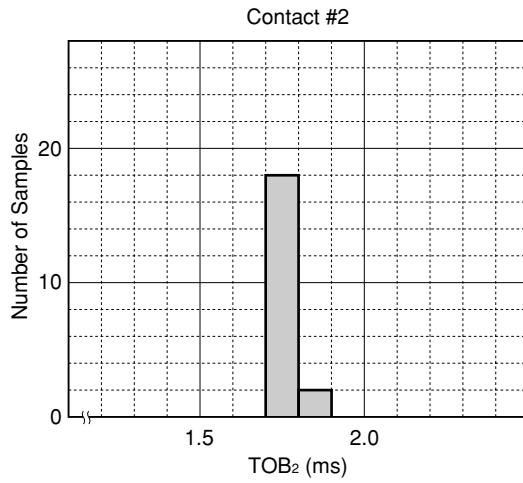
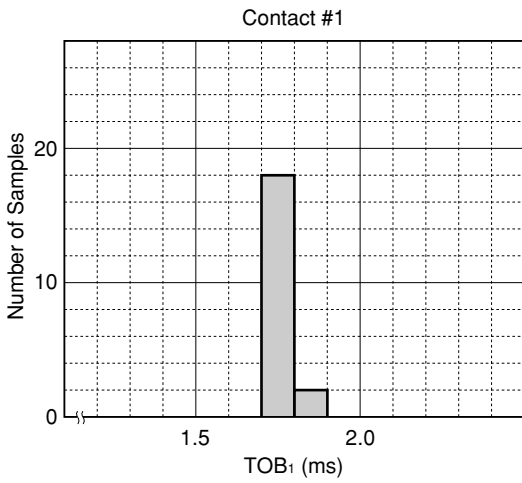

(3) Off times of make contacts at release (TRM)

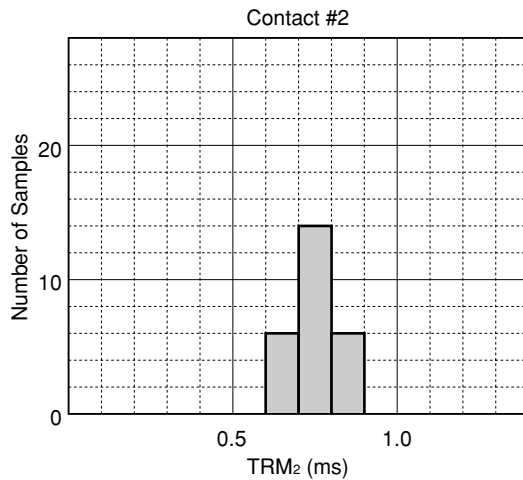
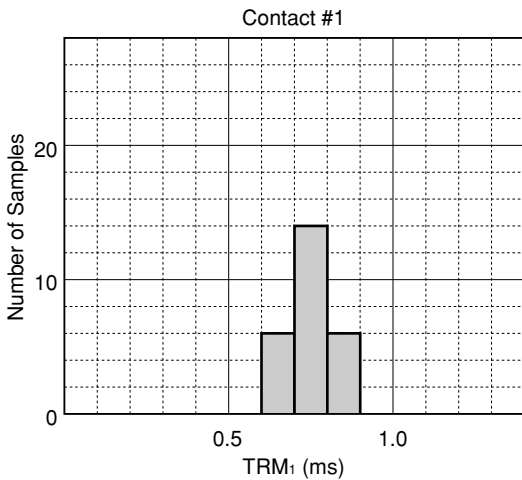
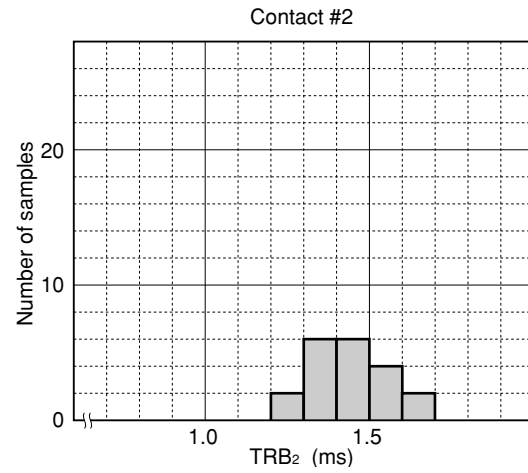
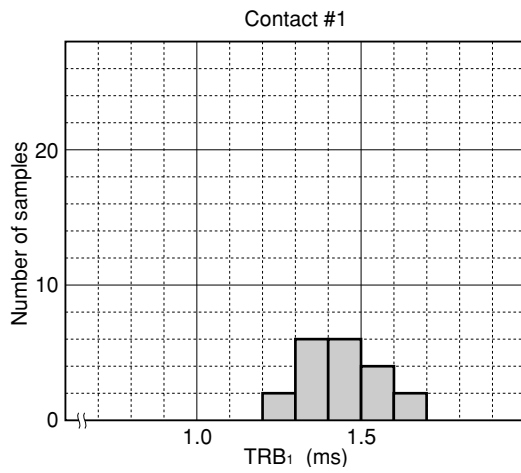
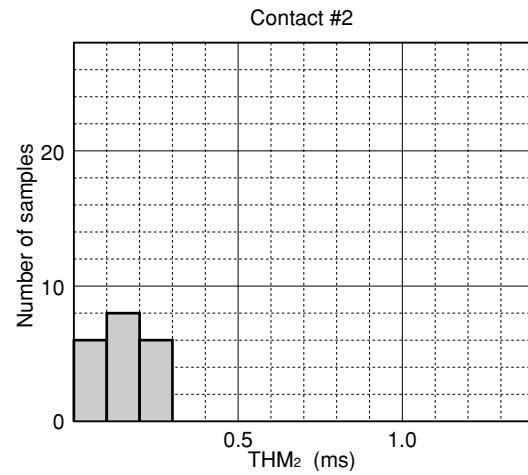
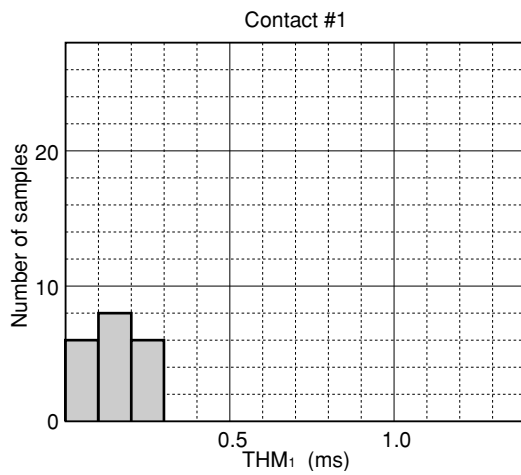

Figure 4.4B Timing

(4) On times of break contacts at release (TRB)



(5) Bounce times of make contacts at operation (THM)



(6) Bounce times of break contacts at release (THB)

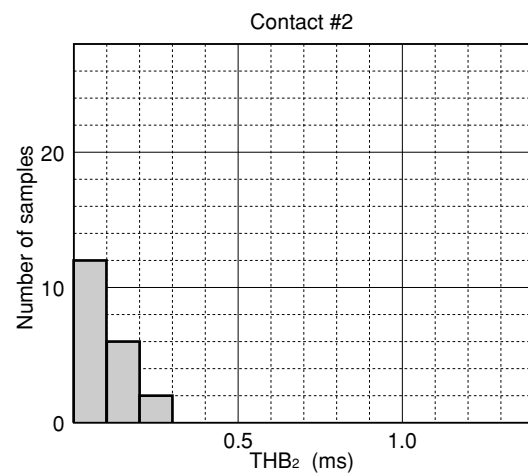
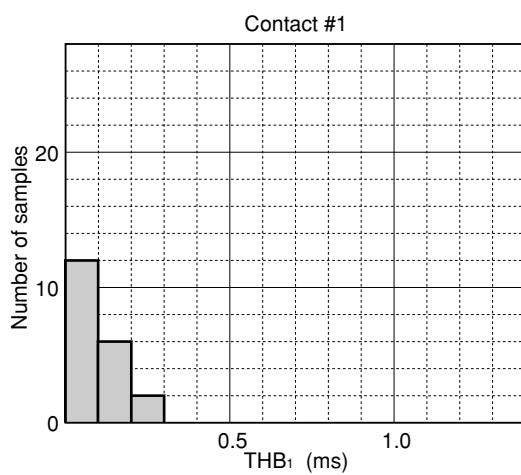
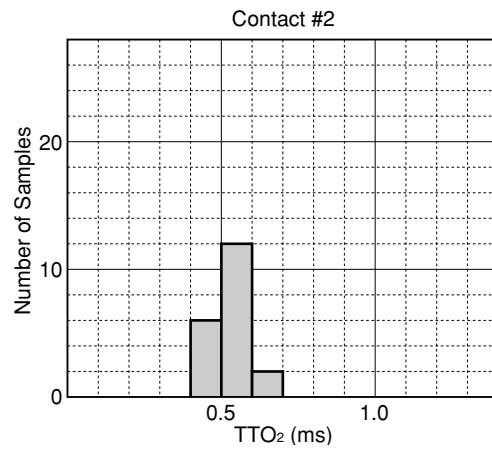
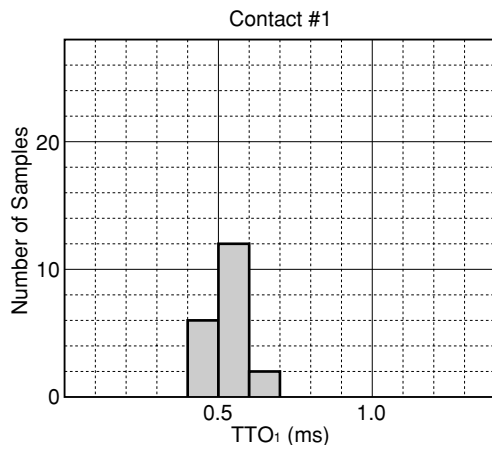
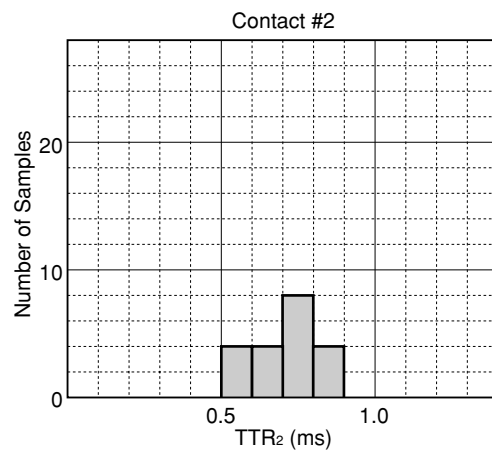
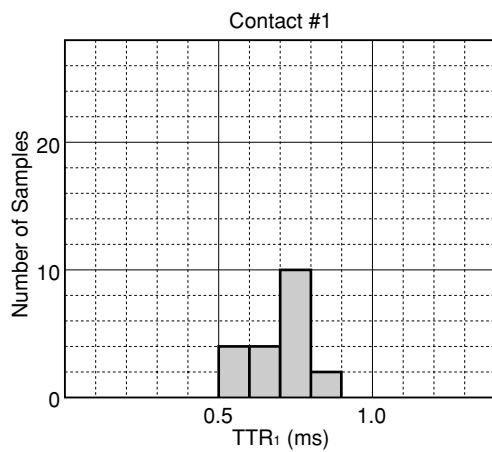

Figure 4.4C Timing

(7) Operate transfer times (TTO)



(8) Release transfer times (TTR)



(9) Common open times

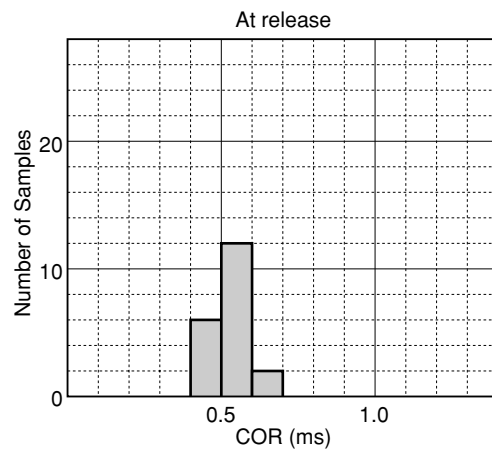
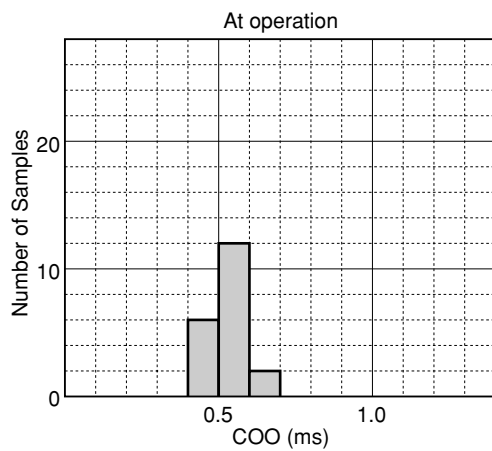
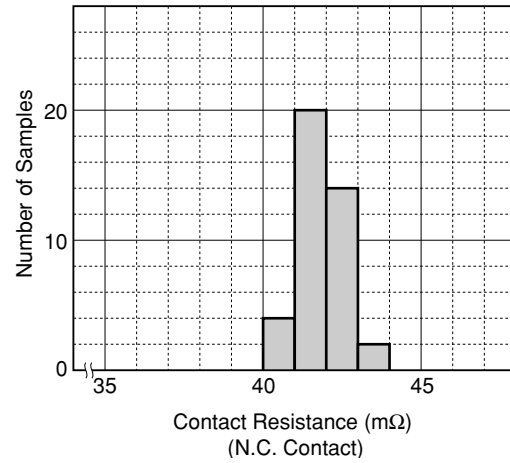
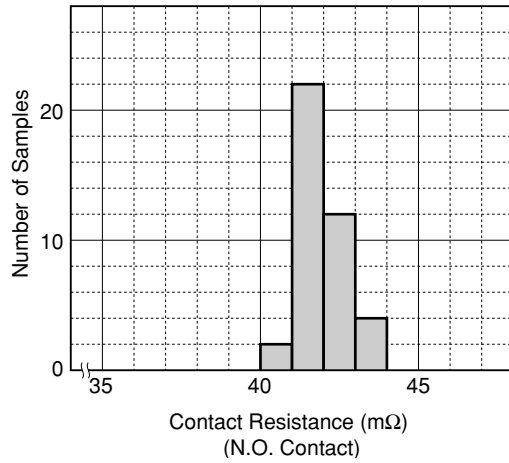

Figure 4.4D Timing

4.5 Contact resistance

This section gives data on the resistance of the contacts when the contacts are closed. The number of sample used for measurement of the contact resistance is 40 each.

(1) Non-latching, 5-V type (sample: EA2-5)



(2) Non-latching, 24-V type (sample: EA2-24)

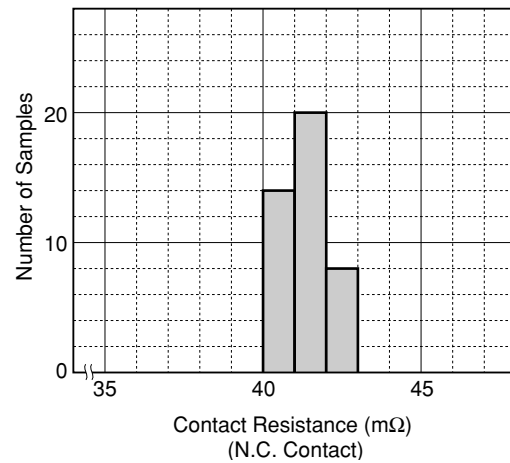
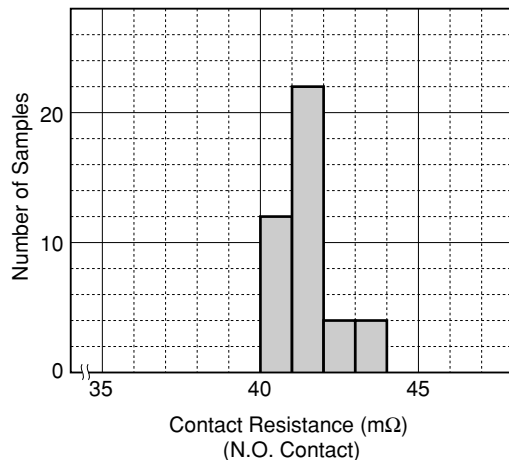

(3) Latching of single-wound coil, 5-V type (sample: EA2-5S)

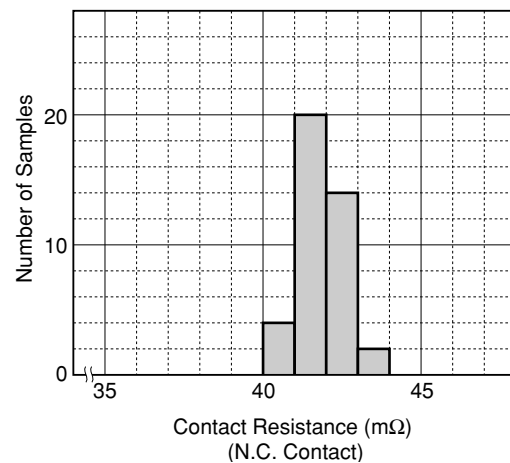
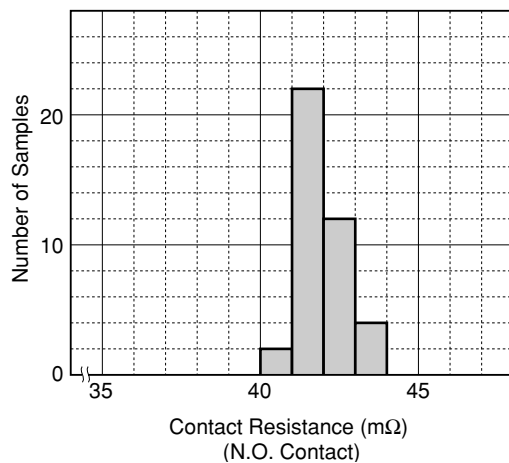

Figure 4.5 Contact Resistance

4.6 Breakdown voltage

This section gives data on the breakdown voltage between terminals of the EA2 series relay.

(Sample: EA2-5, n = 10 pcs.)

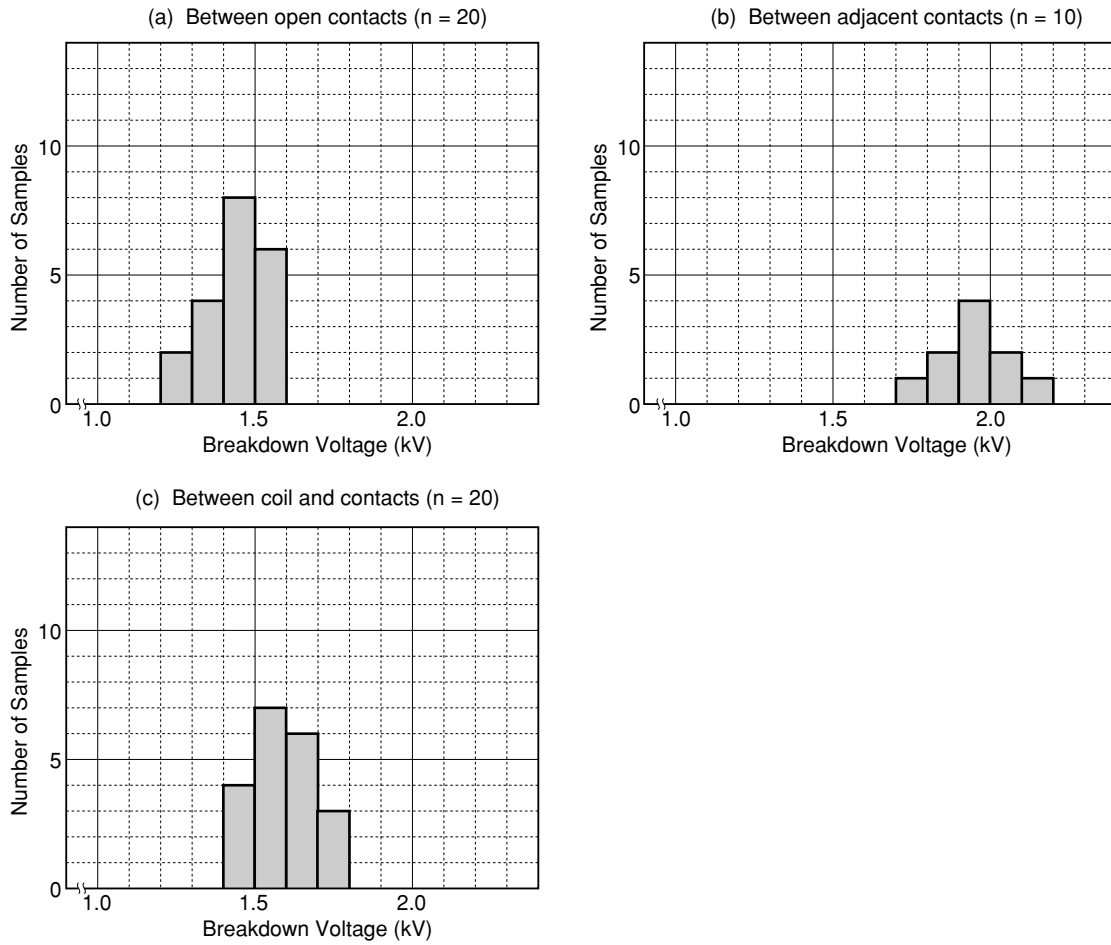

Figure 4.6 Breakdown Voltage

4.7 Thermal EMF (offset voltage between contacts)

This section gives data on the thermal EMF which is a voltage that appears when the contacts are closed.

(Sample: EA2-5, number of samples = 10 pcs., number of data = 20)

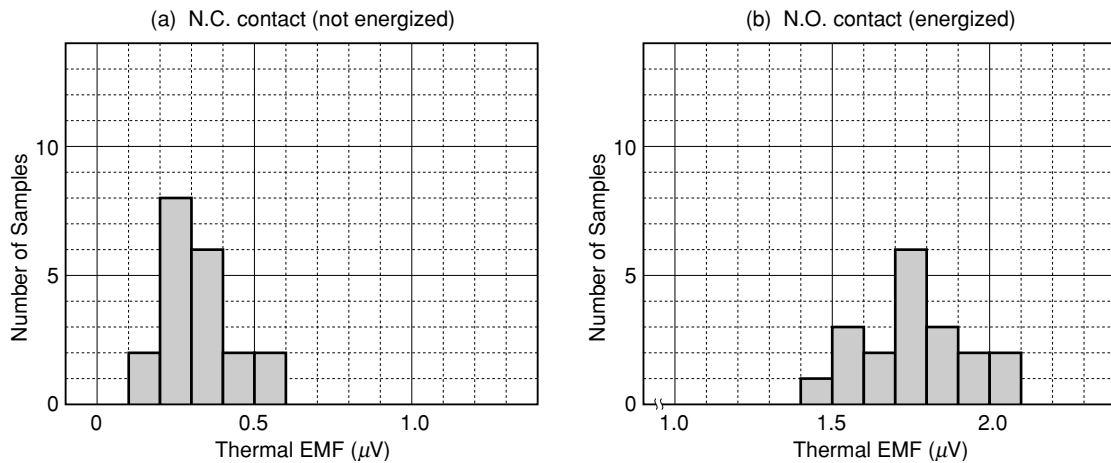

Figure 4.7 Thermal EMF

5. Test Data

This chapter shows examples of the results of environmental tests (refer to 5.1 for details) and contact life tests (refer to 5.2). The table below lists the types of tests, conditions, and data. As the sample, the EA2-5 and EA2-5S are used for the environmental tests, and the EA2-5 is used for the contact life tests.

Table 5 Types of Tests, Conditions, and Data

Test		Test Conditions	Refer to Page:
Environmental test	High-temperature test	Ambient temperature: +105°C Duration: 672 hours	24, 25
	Low-temperature test	Ambient temperature: -40°C Duration: 672 hours	26
	Moisture resistance test	Ambient temperature: -10 to +65°C Humidity: 95% RH, test cycles: 10	27
	Heat shock test	Ambient temperature: -55/+85°C Test cycles: 100	28
	Vibration test	Amplitude: 1.52 mm, Test time: 2 hours each in X, Y, and Z directions Frequency: 10 to 500 Hz, Peak acceleration: 20 G	29
	Shock test	Waveform: Half sine wave, 75 G max. 6 Times each in X, Y, and Z directions, totaling 36 times	30
	Resistance to solder heat test	Solder temperature: 260 ± 10°C Immersion time: 10 seconds	31
	Terminal strength	Ambient temperature: 25°C, Tensile strength: 1.36 kg Number of times of bending: 2	32
Contact life test	Non-load test A	25°C	33
	Non-load test B	85°C	34
	Resistive load test A	10 mA, 10 μA, 25°C	34
	Resistive load test B	10 Vdc, 10 mA, 85°C	35
	Resistive load test C	28 Vdc, 100 mA, 85°C	35
	Resistive load test D	50 Vdc, 100 mA, 25°C	36
	Resistive load test E	50 Vdc, 100 mA, 85°C	36
	Inductive load test	48 Vdc, 110 mA, 25°C	37
	Resistive load test F	220 Vdc, 0.14 A, 25°C	37
	Resistive load test G	125 Vdc, 0.5 A, 25°C	38
Resistive load test H	30 Vdc, 1 A, 25°C	38	

5.1 Environmental tests

This section shows the results of environmental tests to be conducted to evaluate the performance of the relay under specific storage and operating environmental conditions. No abnormality was found after all the tests had been conducted.

- * The operate and release voltages, contact resistance, operate and release times, and transfer time of the sample before and after each test were compared, but no major change in these parameters was observed, and the sample still satisfied the initial standard values of the parameters after the test. For details, refer to the graph for each test.
- * The initial standard value of the insulation resistance of $10^9 \Omega$ or higher was still satisfied after the test.
- * The initial standard value of the breakdown voltage of 1000 Vac was satisfied for 1 minute after the test.
- * After each test, no abnormality was found in the appearance. The cover of the relay was removed and the internal mechanism was also inspected visually for dirt, deformation, and other abnormalities, but no such abnormalities was found.
- * After each test, a sealability test was conducted to examine the sealability of the relay by immersing the relay into a fluorocarbon solution and checking to see if the internal gas of the relay leaked out. No abnormality was observed as a result of this sealability test.

5.1.1 High-temperature test (test conditions: temperature: +105°C, duration: 672 hours, sample: 10 pcs. each)

This test was conducted to check whether the performance of the relay is degraded after the relay has been left at the upper-limit value of the rated ambient temperature for the specified duration.

(1) Non-latching, 5-V type

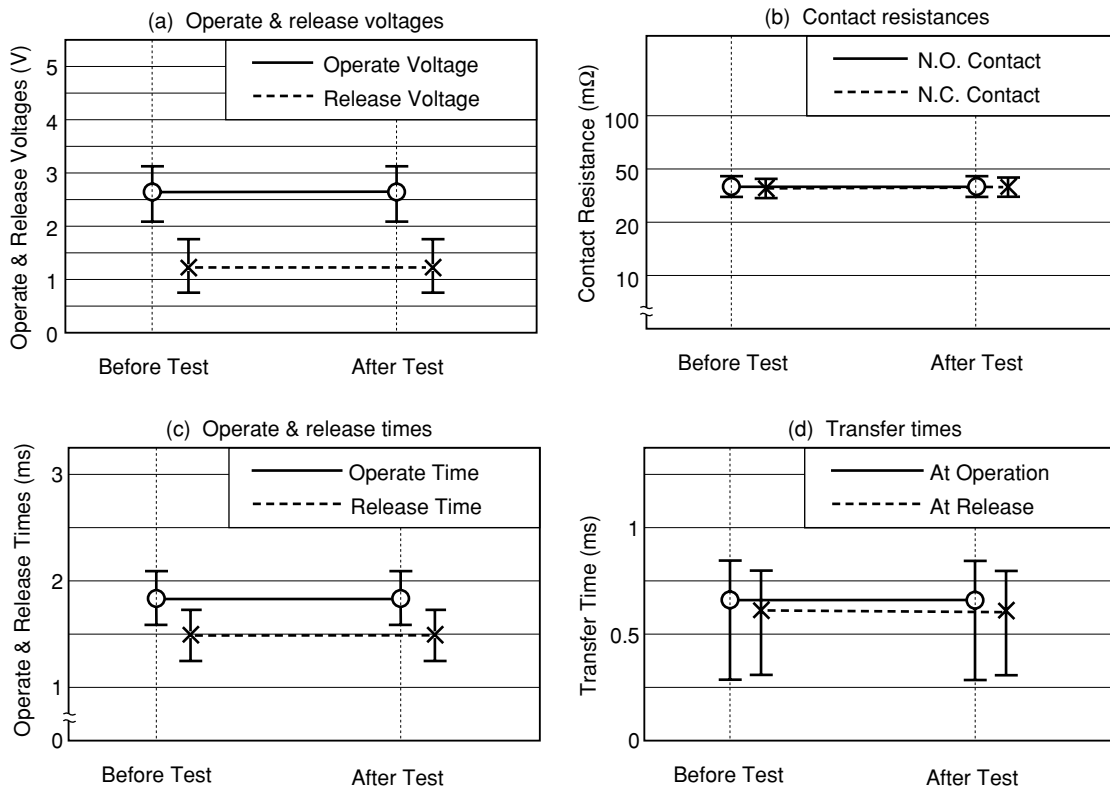

Figure 5.1 (1) High-temperature Test

(2) Latching of single-wound coil, 5-V type

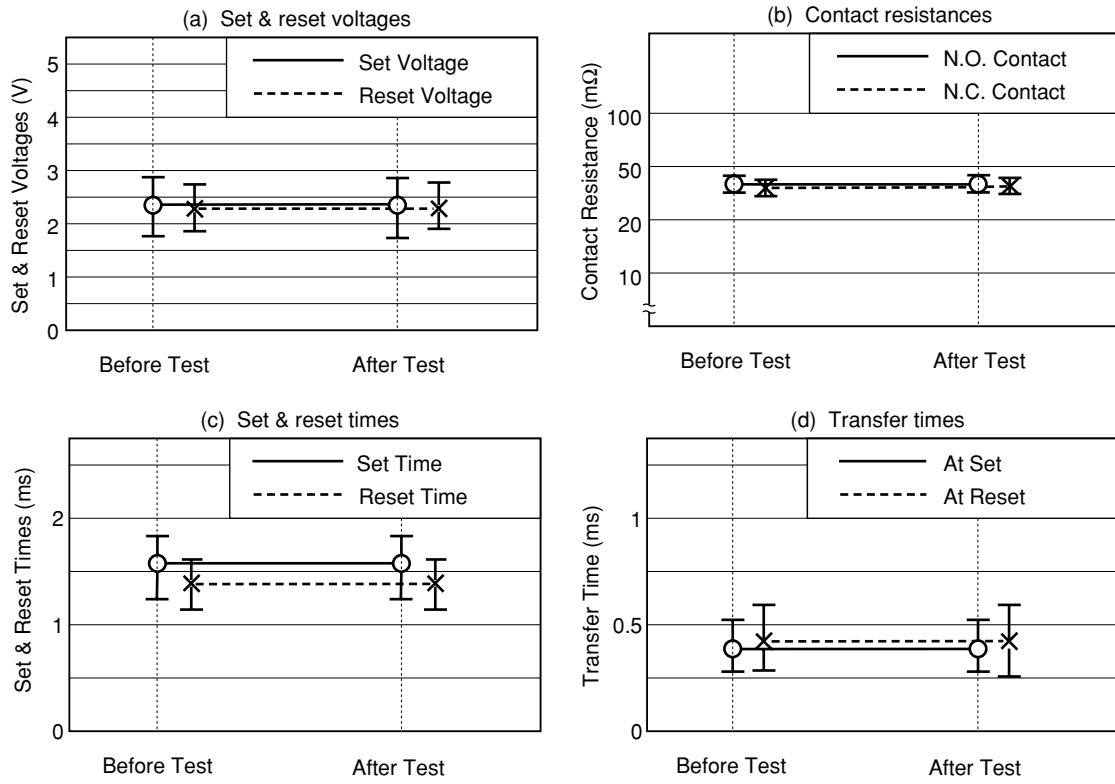

Figure 5.1 (2) High-temperature Test

5.1.2 Low-temperature test (test conditions: temperature: -40°C , duration: 672 hours, sample: 10 pcs. each)

This test was conducted to check whether the performance of the relay is degraded after the relay has been left at the lower-limit value of the rated ambient temperature for the specified duration.

(1) Non-latching, 5-V type

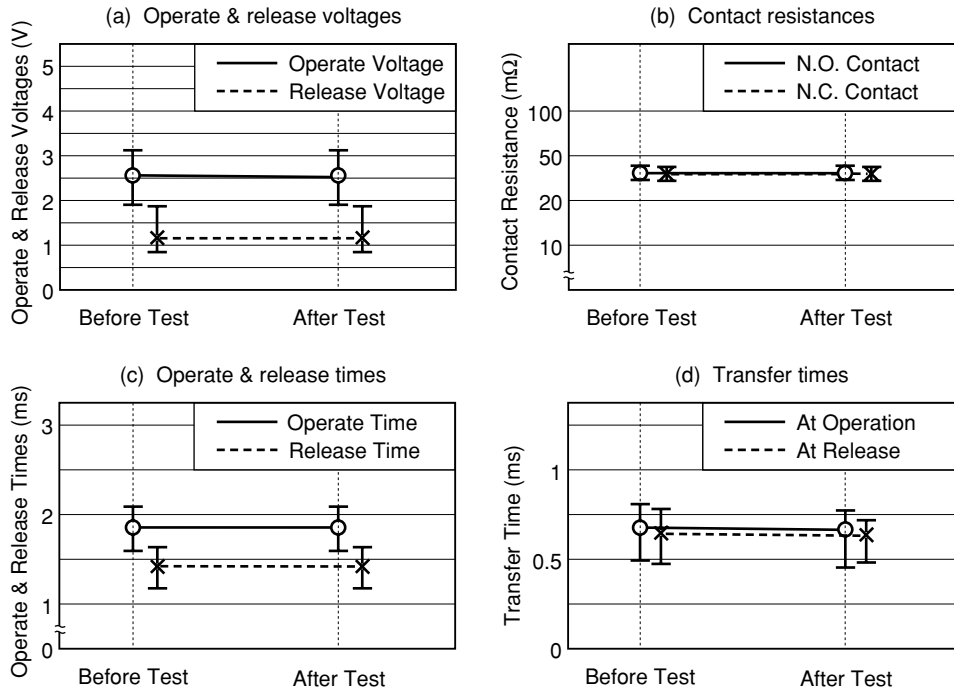

Figure 5.2 (1) Low-temperature Test

(2) Latching of single-wound coil, 5-V type

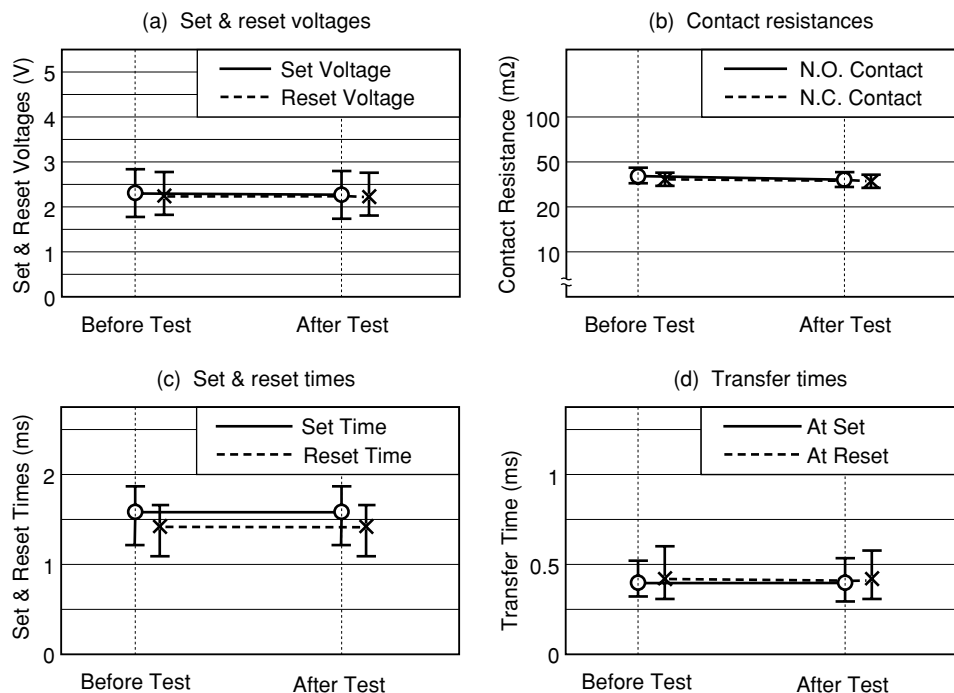

Figure 5.2 (2) Low-temperature Test

5.1.3 Moisture resistance test (test conditions: temperature: -10 to 65°C , humidity: 90 to 98% RH, test cycles: 10, sample: 10 pcs. each)

This test was conducted to check whether the performance of the relay is degraded after the relay has been left in a highly humid atmosphere for the specified duration.

(1) Non-latching, 5-V type

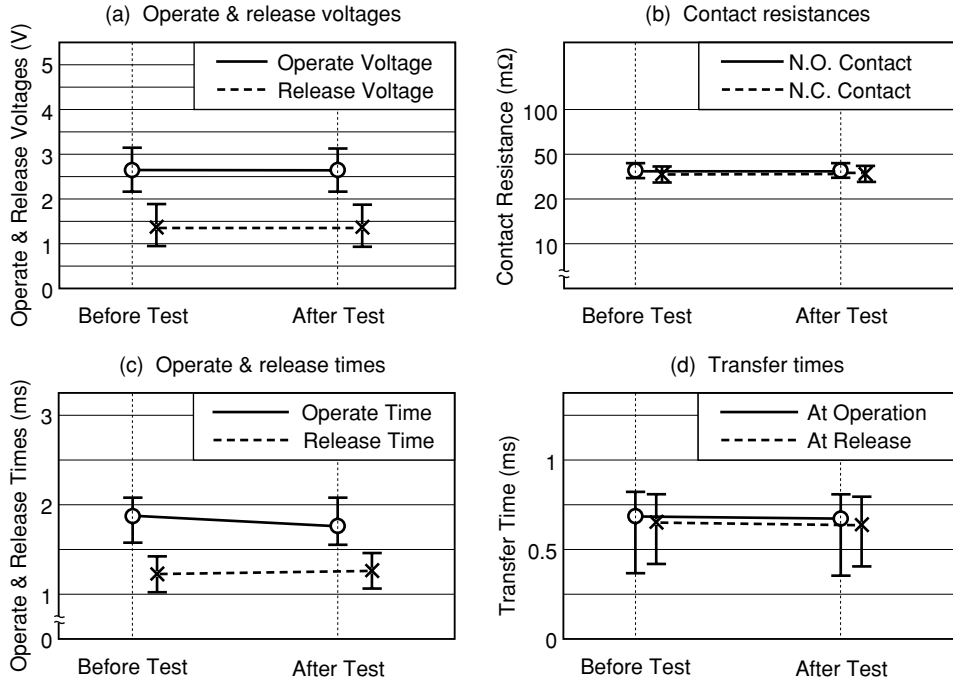

Figure 5.3 (1) Moisture Resistance Test

(2) Latching of single-wound coil, 5-V type

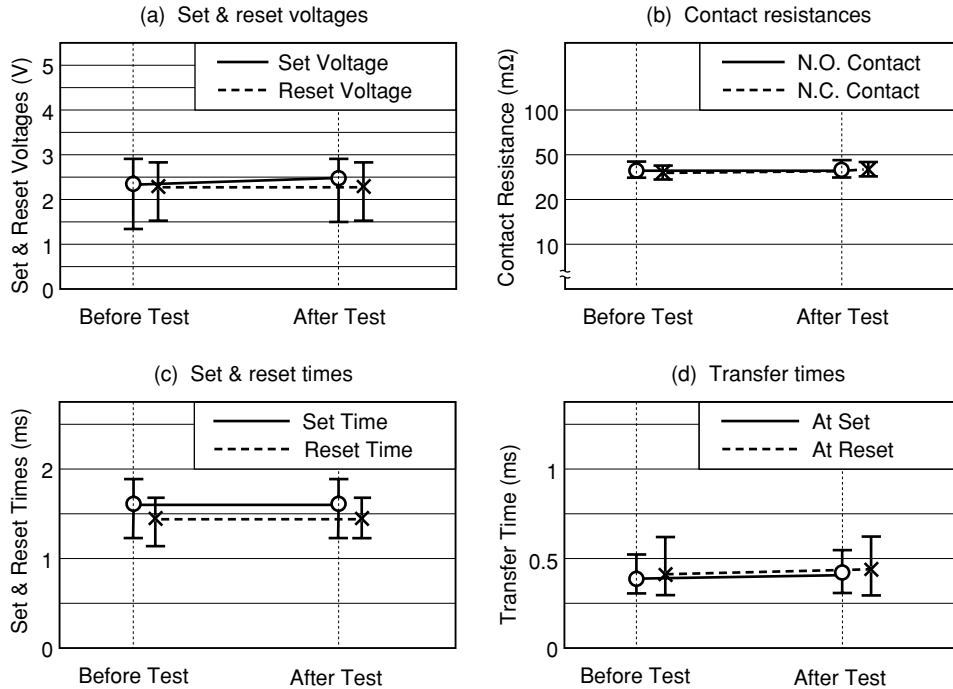

Figure 5.3 (2) Moisture Resistance Test

5.1.4 Heat shock test (test conditions: temperature: -55°C to 85°C , test cycles: 100, sample: 10 pcs, each)
 This test is to check whether the performance of the relay is degraded if the ambient temperature abruptly changes.

(1) Non-latching, 5-V type

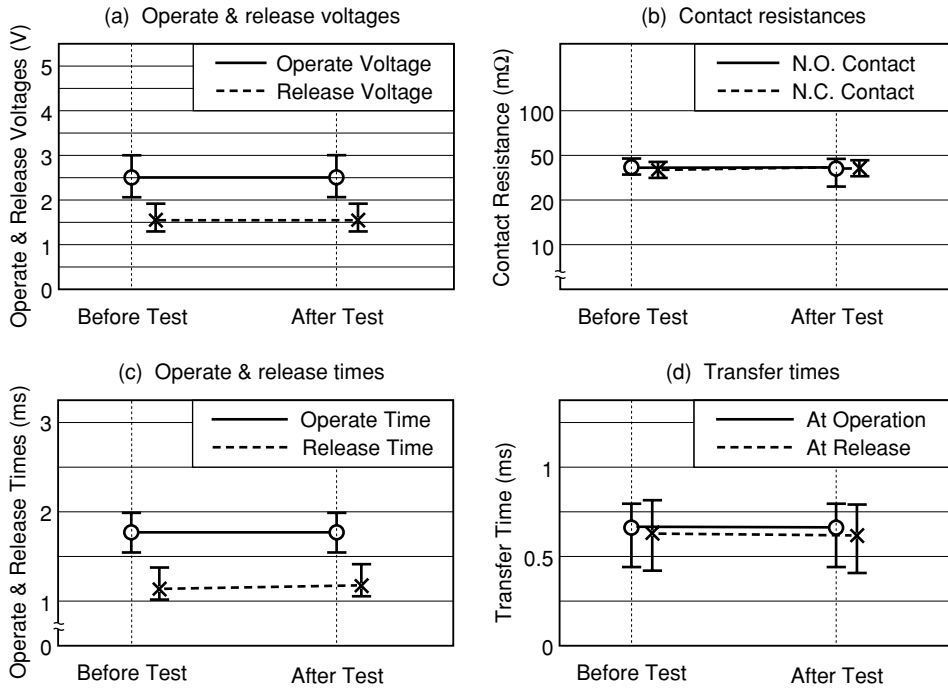

Figure 5.4 (1) Heat Shock Test

(2) Latching of single-wound coil, 5-V type

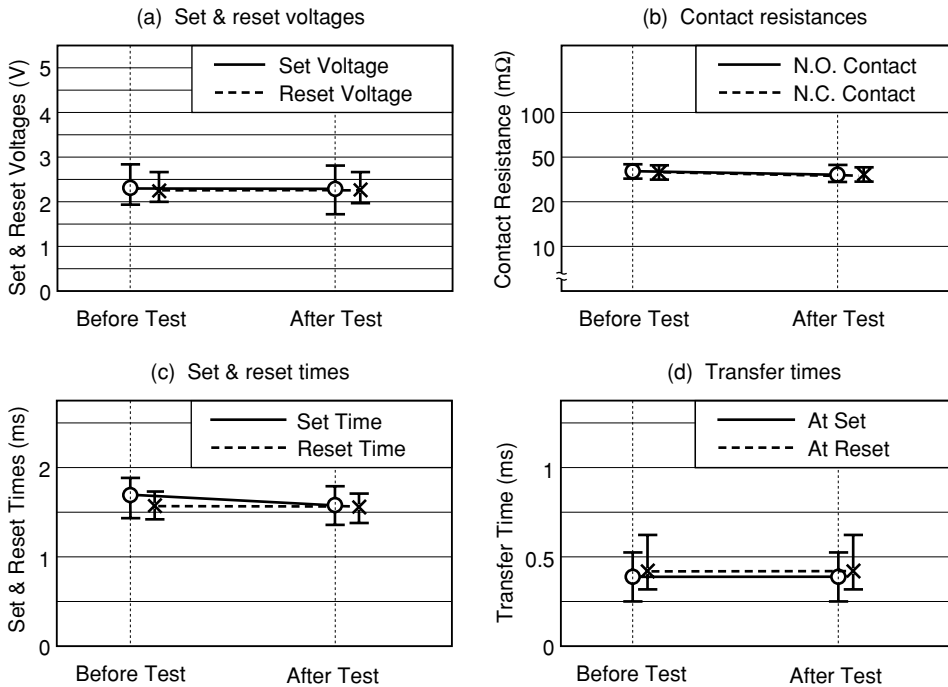

Figure 5.4 (2) Heat Shock Test

5.1.5 Vibration test (test conditions: amplitude: 1.52 mm, frequency: 10 to 500 Hz, 20 G peak, test time: 2 hours each in X, Y, and Z directions, totaling 6 hours, sample: 10 pcs. each)

This test is conducted to check whether the performance of the relay is degraded after vibration is continuously applied to the relay while the relay is being transported.

(1) Non-latching, 5-V type

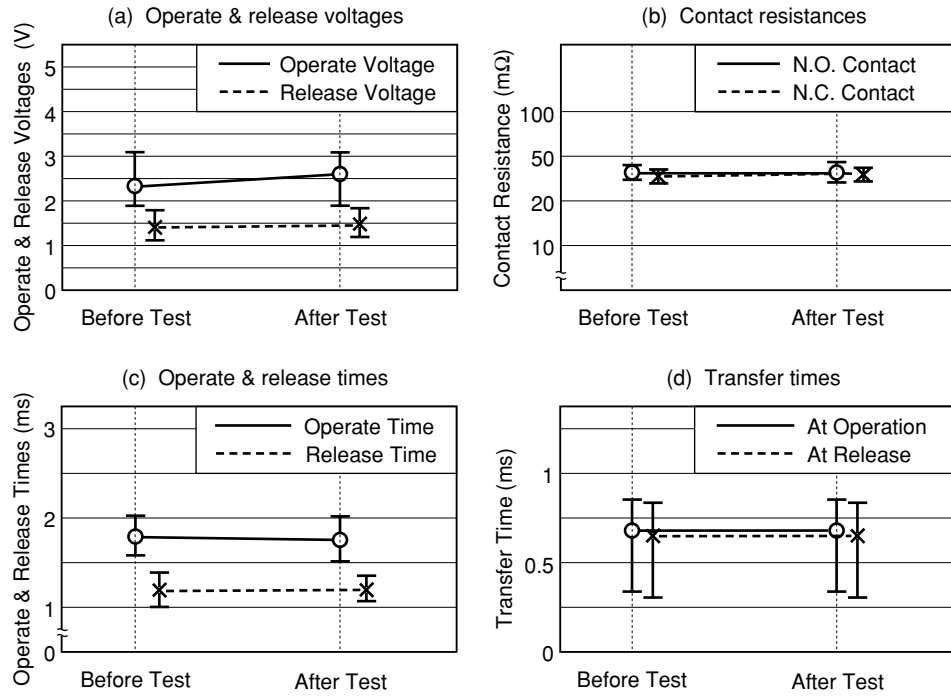

Figure 5.5 (1) Vibration Test

(2) Latching of single-wound coil, 5-V type

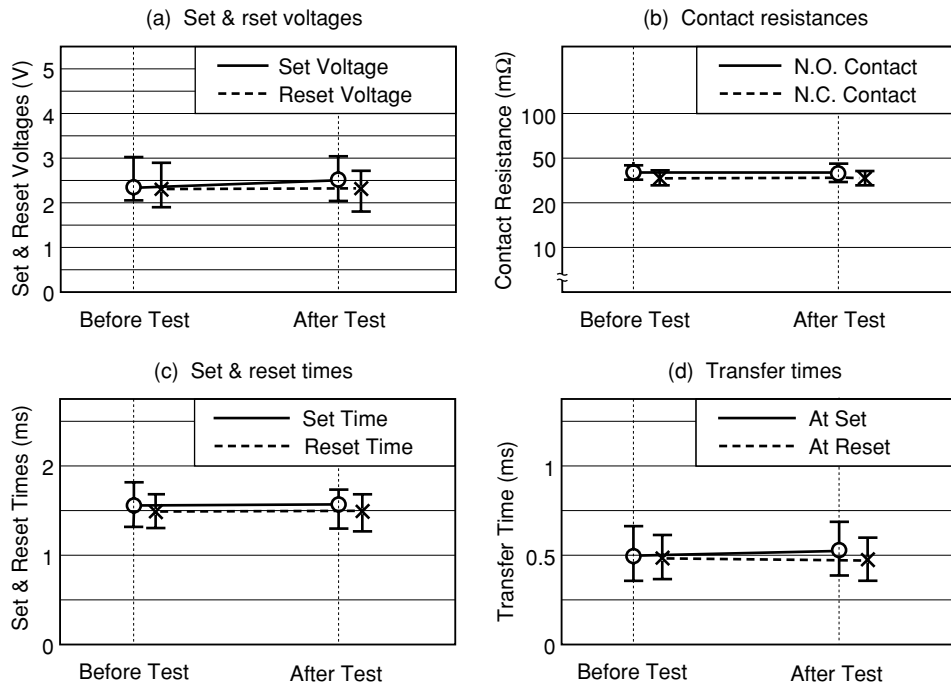

Figure 5.5 (2) Vibration Test

5.1.6 Shock test (test conditions: waveform: half sine wave, peak acceleration: 75 G, 6 times each in X, Y, and Z directions, totaling 36 times, sample: 10 pcs. each)

This test is conducted to check whether the performance of the relay is degraded after an abrupt shock is applied to the relay while the relay is being transported.

(1) Non-latching, 5-V type

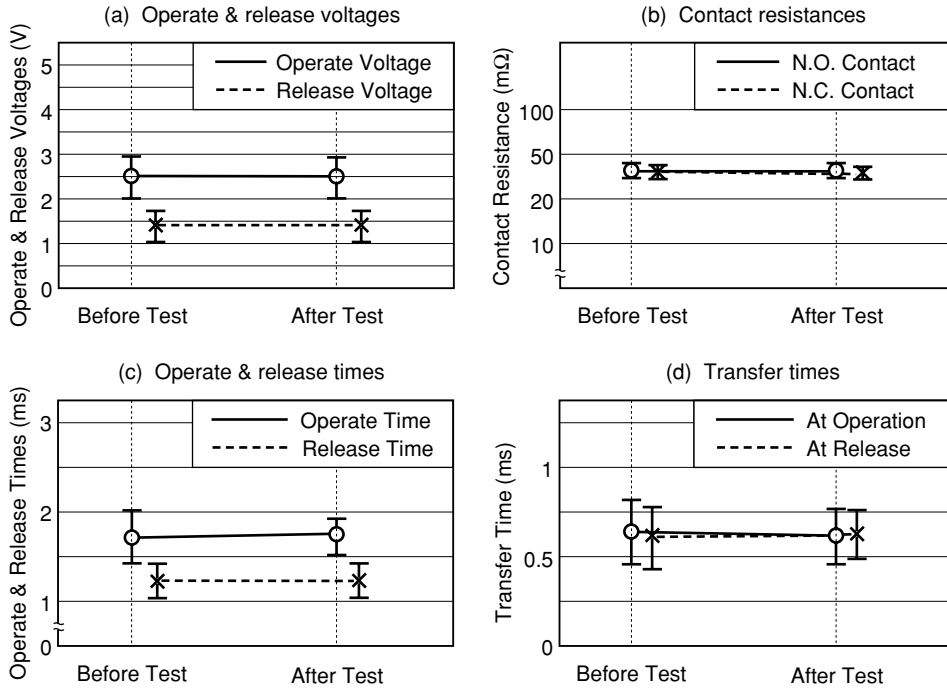

Figure 5.6 (1) Shock Test

(2) Latching of single-wound coil, 5-V type

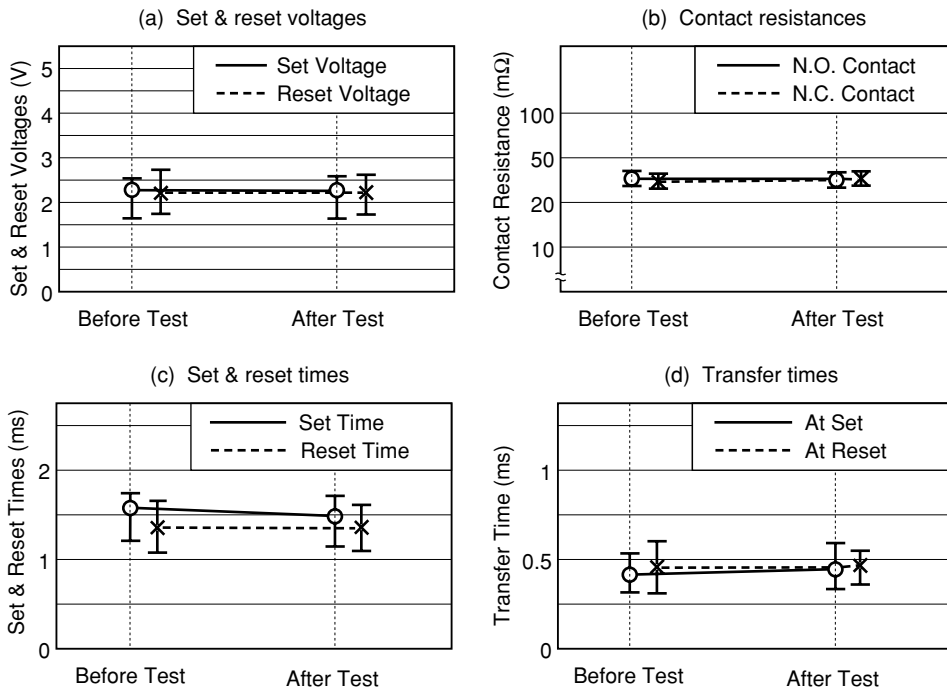

Figure 5.6 (2) Shock Test

5.1.7 Resistance to solder heat test (test conditions: solder temperature = $260 \pm 10^\circ\text{C}$, immersion time: 10 seconds, sample: 10 pcs. each)

This test is conducted to check whether the performance of the relay is degraded after the relay has been exposed to heat when it is soldered to a printed circuit board (PCB).

(1) Non-latching, 5-V type

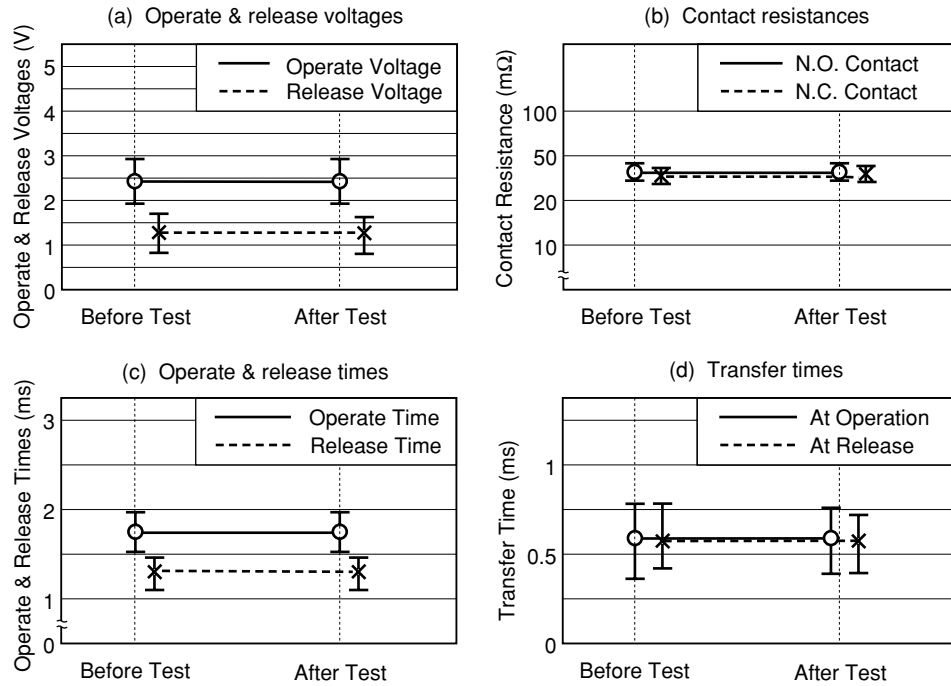

Figure 5.7 (1) Resistance to Solder Heat Test

(2) Latching of single-wound coil, 5-V type

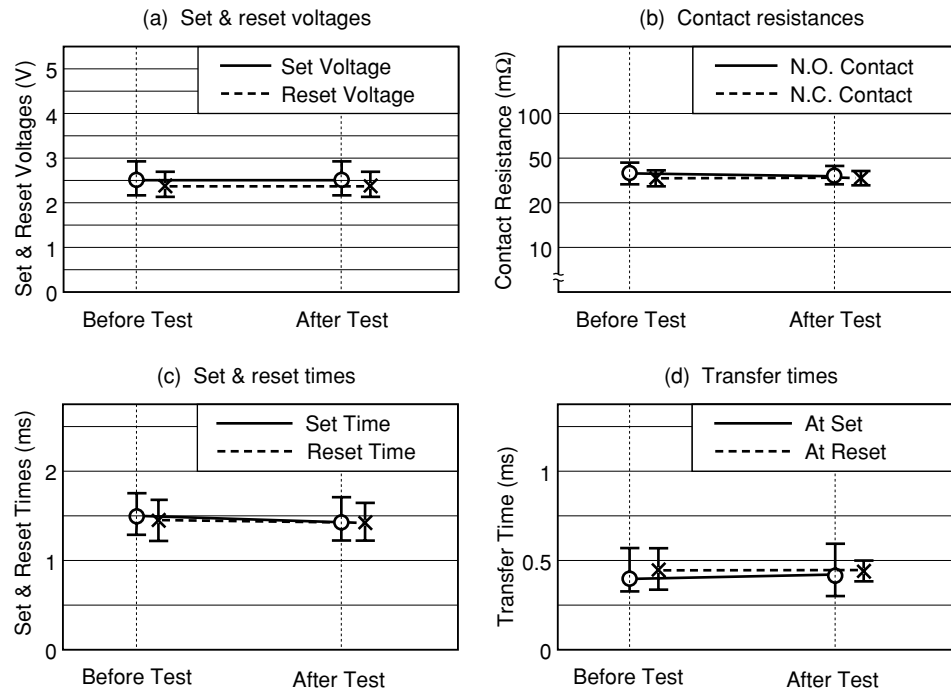

Figure 5.7 (2) Resistance to Solder Heat Test

5.1.8 Terminal strength test (test conditions: ambient temperature: 25°C, tensile strength: 1.36 kg, number of times of bending: 2, sample: 10 pcs. each)

The purpose of this test is to check whether the performance of the relay is degraded after an excessive force is applied to the terminals of the relay when the relay is mounted on a PCB.

(1) Non-latching, 5-V type

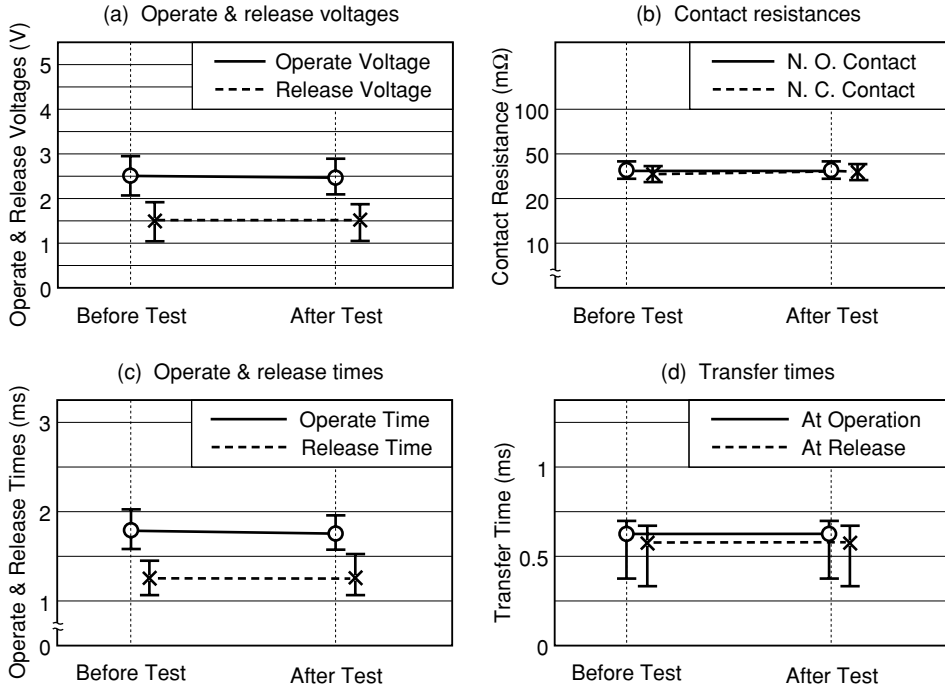

Figure 5.8 (1) Terminal Strength

(2) Latching of single-wound coil, 5-V type

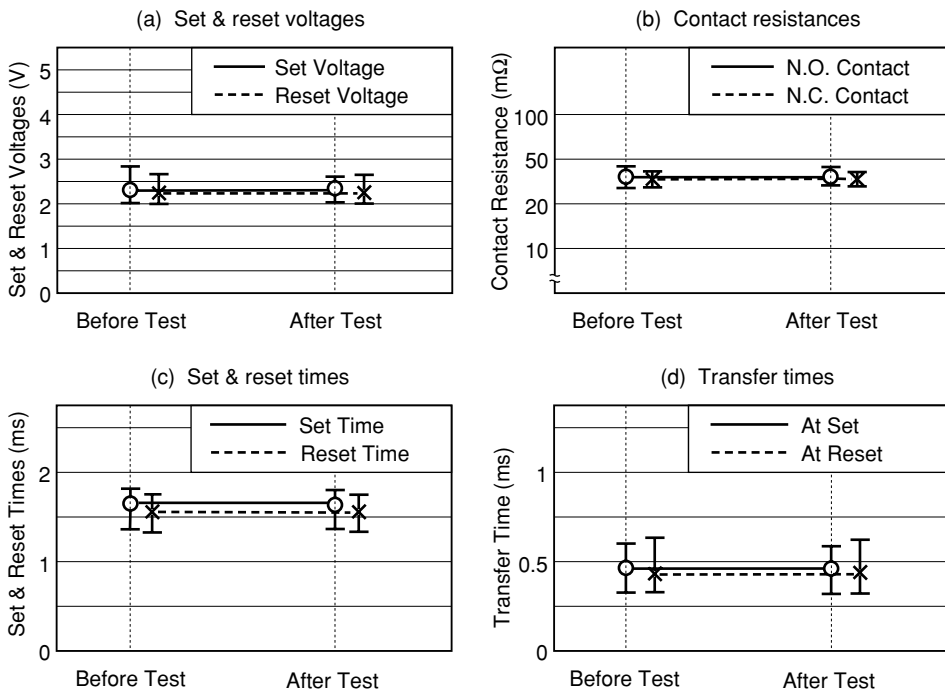

Figure 5.8 (2) Terminal Strength

5.2 Contact life tests

This section shows the results of tests conducted to examine the service life of the contacts, which has a significant influence on the life of the relay.

To test the service life of the contacts, the operate and release voltages, contact resistance, operate and release times, and transfer time of each relay is measured each time the relay has performed the specified number of operations under the specified conditions.

For changes in the characteristics, refer to the graphs shown below.

5.2.1 Non-load test A (driving frequency: 50 Hz, ambient temperature: +25°C, sample: 10 non-latching types (rated at 5 V))

The cleanness of the contact surfaces influences the result of this test because no electric load is applied to the relay.

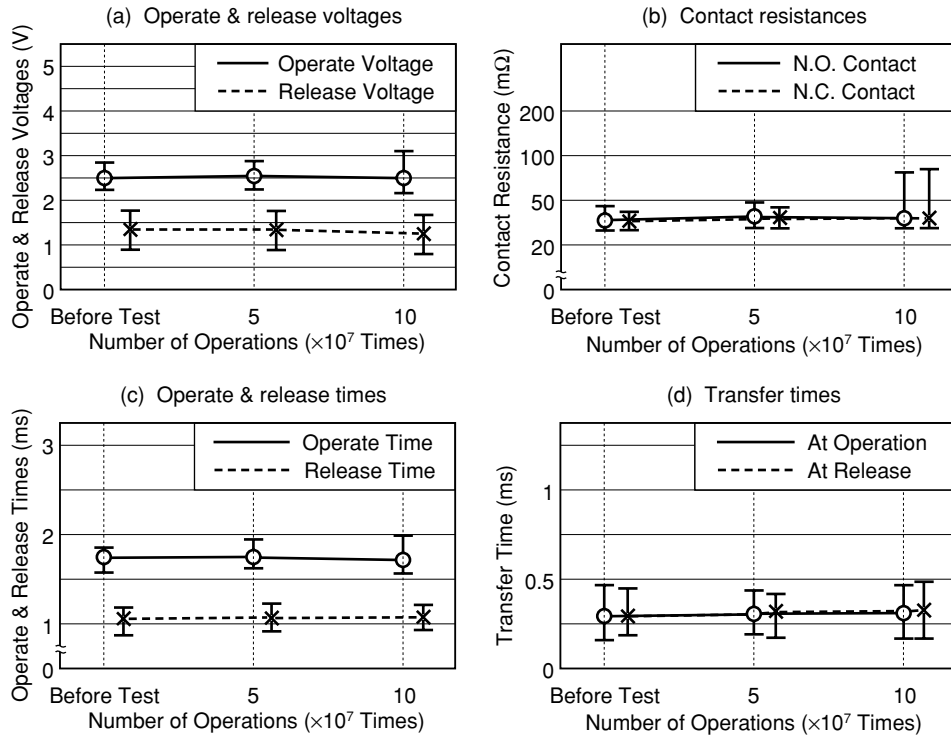

Figure 5.9 Non-load Test A

5.2.2 Non-load test B (driving frequency: 50 Hz, ambient temperature: +85°C, sample: 10 non-latching types (rated at 5 V))

The conditions of this test are more stringent than those of the test in 5.2.1 because the relay is exposed to a higher ambient temperature and consequently organic gas is more likely to be generated inside the relay housing.

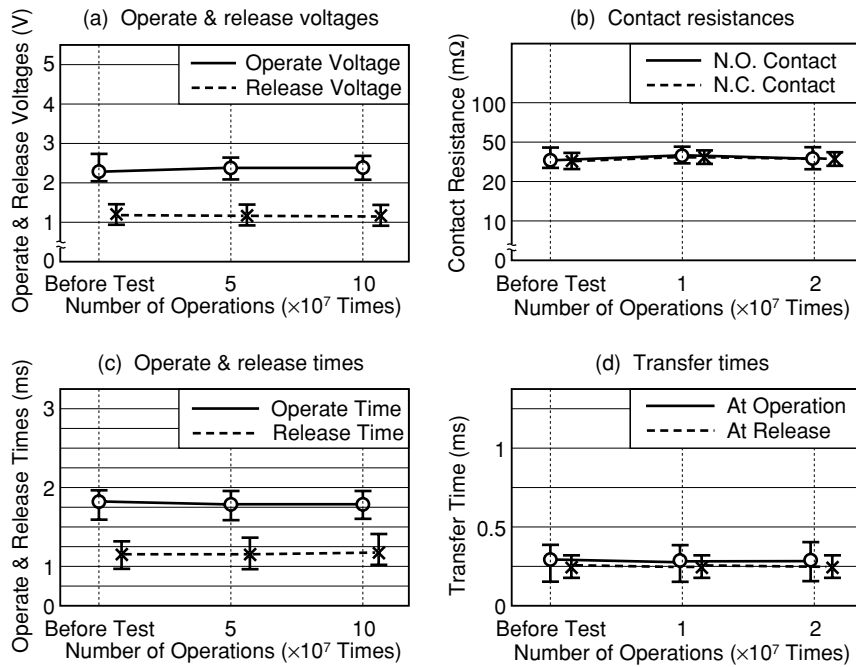

Figure 5.10 Non-load Test B

5.2.3 Resistive load test A (contact load: 10 mVdc, 10 μ A, resistive, driving frequency: 25 Hz, ambient temperature: +25°C, sample: 10 non-latching types (rated at 5 V))

This test is conducted with the relay under the minimum applied load condition.

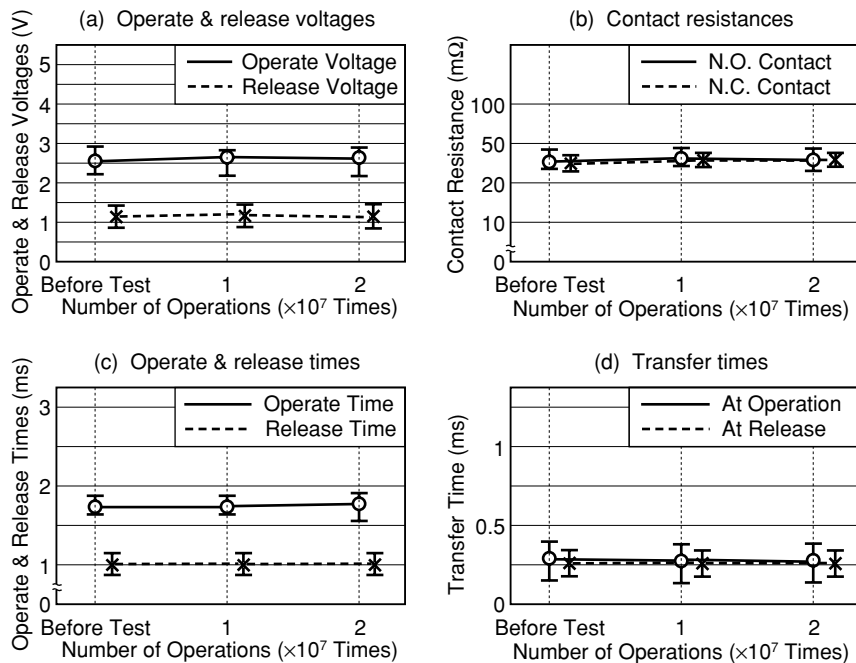

Figure 5.11 Resistive Load Test A

5.2.4 Resistive load test B (contact load: 10 Vdc, 10 mA, resistive, driving frequency: 2 Hz, ambient temperature: +85°C, sample: 10 non-latching types (rated at 5 V))

This test is conducted with a load equivalent to the signal level of an IC applied to the relay.

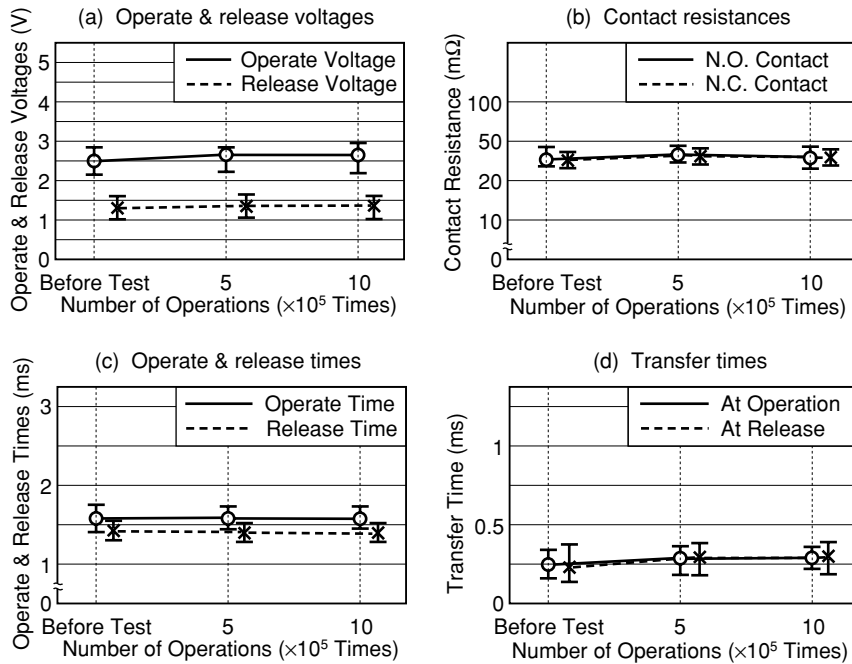

Figure 5.12 Resistive Load Test B

5.2.5 Resistive load test C (contact load: 28 Vdc, 100 mA, resistive, driving frequency: 2 Hz, ambient temperature: +85°C, sample: 10 non-latching types (rated at 5 V))

This test is conducted with a load of medium level applied to the relay contacts.

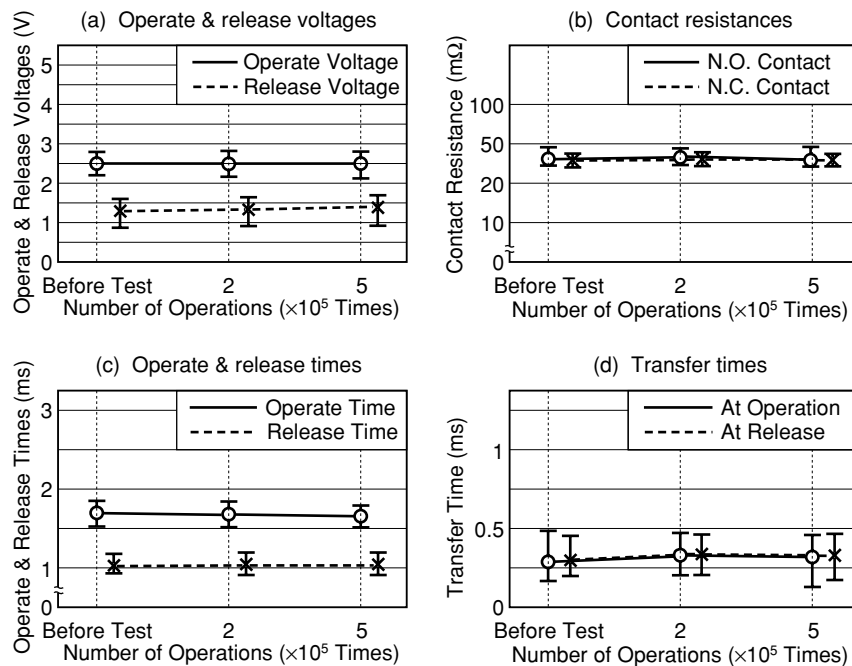

Figure 5.13 Resistive Load Test C

5.2.6 Resistive load test D (contact load: 50 Vdc, 100 mA, resistive, driving frequency: 5 Hz, ambient temperature: +25°C, sample: 10 non-latching types (rated at 5 V))

The load conditions of this test are equivalent to the voltage and current levels of a public telephone circuit.

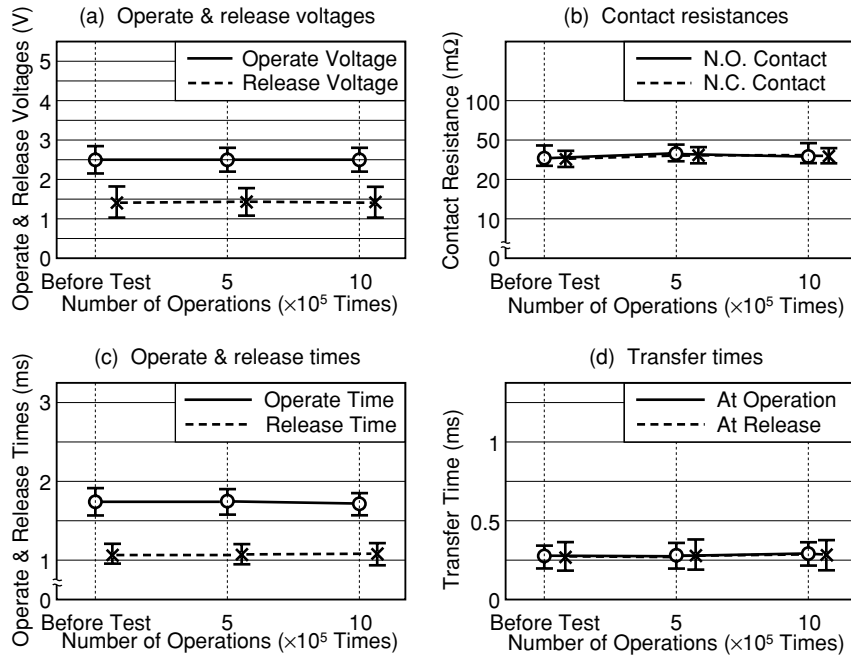

Figure 5.14 Resistive Load Test D

5.2.7 Resistive load test E (contact load: 50 Vdc, 100 mA, resistive, driving frequency: 5 Hz, ambient temperature: +85°C, sample: 10 non-latching types (rated at 5 V))

The conditions of this test are more stringent for the relay than those in 5.2.6 above because the ambient temperature is higher.

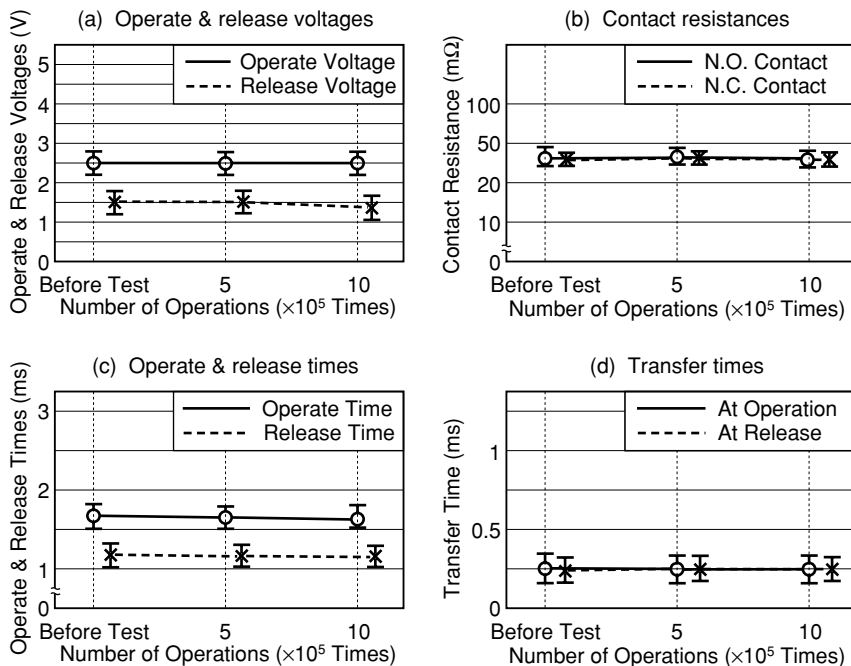

Figure 5.15 Resistive Load Test E

5.2.8 Inductive load test (contact load: 48 Vdc, 110 mA, inductive load by wire spring relay, driving frequency: 2 Hz, ambient temperature: +25°C, sample: 10 non-latching types (rated at 5 V))

The conditions of this test are practical load conditions under which the relay is used to switch a public telephone circuit.

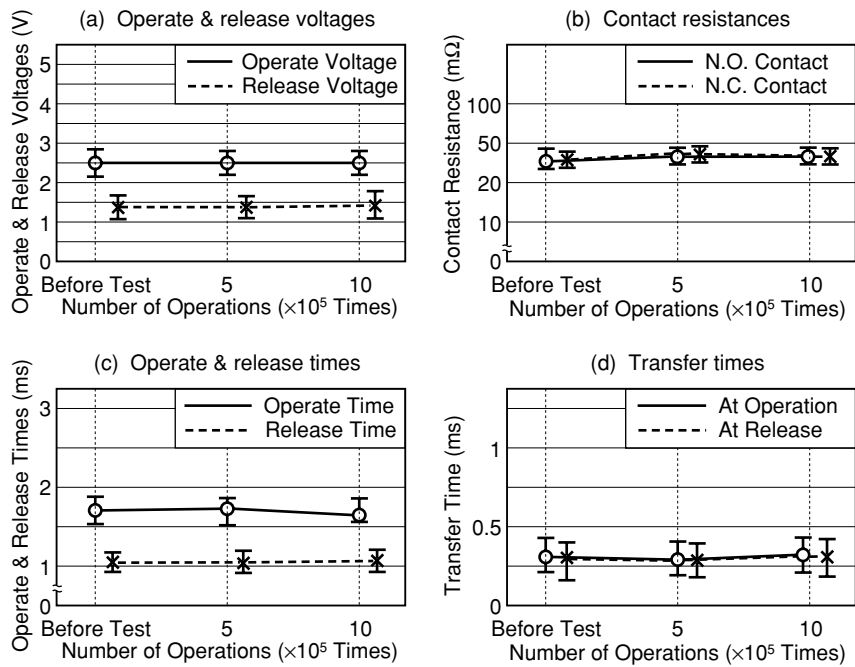

Figure 5.16 Inductive Load Test

5.2.9 Resistive load test F (contact load: 220 Vdc, 0.14 A, resistive, driving frequency: 2 Hz, ambient temperature: +25°C, sample: 10 non-latching types (rated at 5 V))

The load conditions of this test are at the maximum switching voltage and maximum switching power with the contacts switching a DC load.

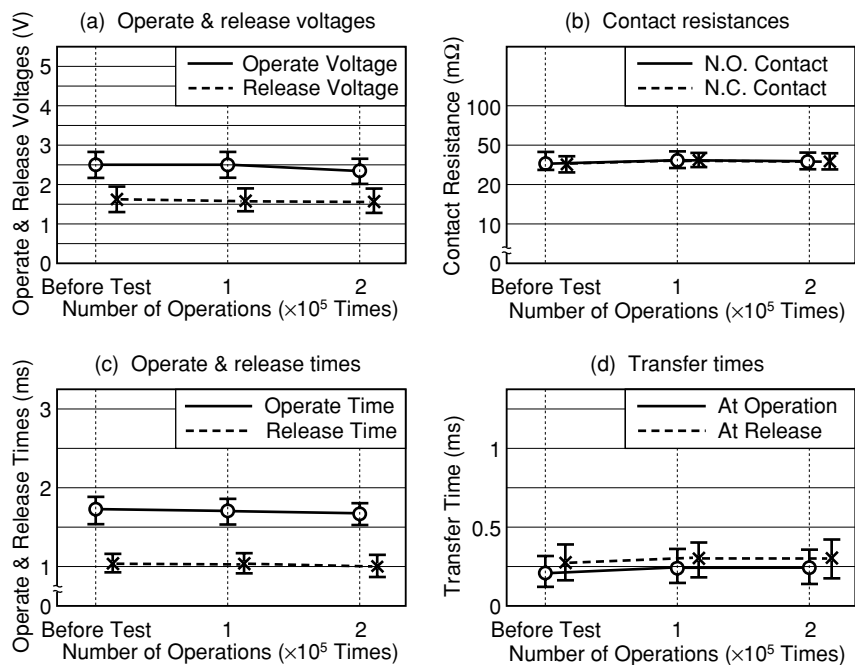

Figure 5.17 Resistive Load Test F

5.2.10 Resistive load test G (contact load: 125 Vac, 0.5 A, resistive, driving frequency: 2 Hz, ambient temperature: +25°C, sample: 10 non-latching types (rated at 5 V))

The load conditions of this test are at the maximum switching voltage and maximum switching power with the contacts switching an AC load.

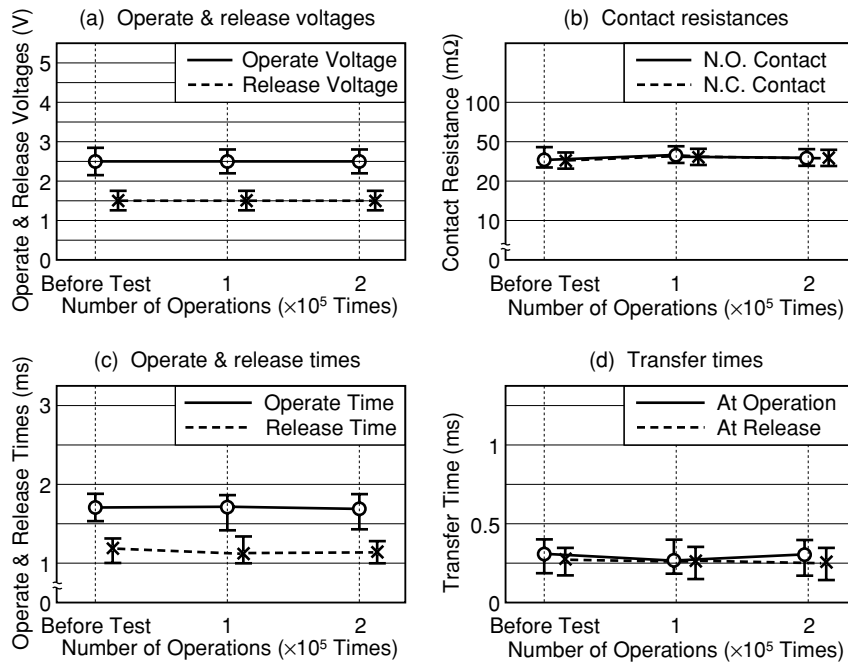

Figure 5.18 Resistive Load Test G

5.2.11 Resistive load test H (contact load: 30 Vdc, 1 A, resistive, driving frequency: 2 Hz, ambient temperature: +25°C, sample: 10 non-latching types (rated at 5 V))

The load conditions of this test are at the maximum switching current and maximum switching power with the contacts switching a DC load.

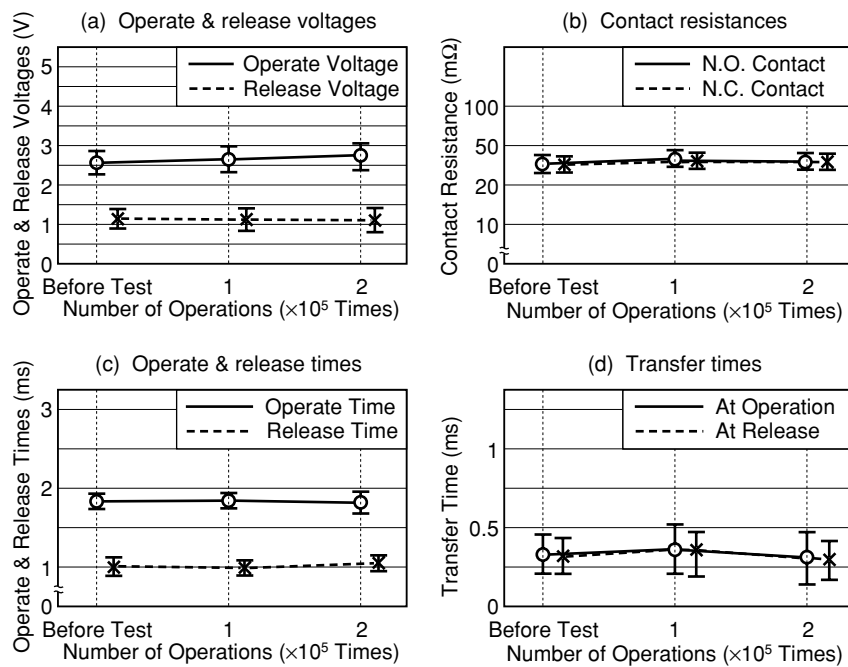
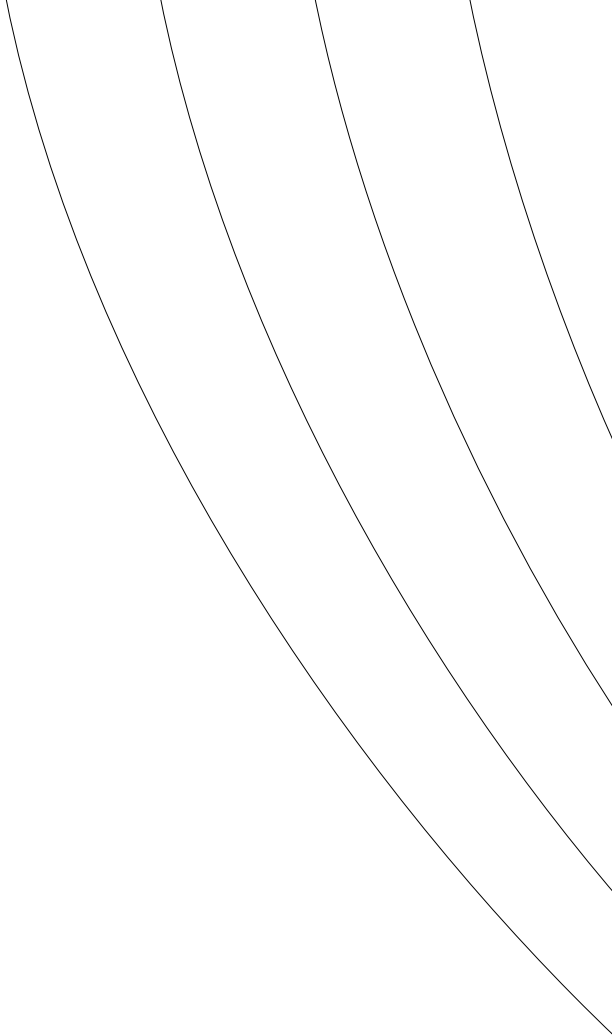

Figure 5.19 Resistive Load Test H



X-ON Electronics

Largest Supplier of Electrical and Electronic Components

Click to view similar products for [nec manufacturer](#):

Other Similar products are found below :

[NL128102AC31-01](#) [621488F](#) [NL10276AC28-02](#) [NL10276AC30-04R](#) [EE2-4.5NUH](#) [NL8060AC26-11/VIS](#) [EF2-5SNU](#) [UPC1352C](#) [EE2-24TNU](#) [UPD43256BCZ-85-LL](#) [UA2-4.5SNU](#) [QF62V1](#) [UD2-9NU](#) [EE2-3TNUX](#) [UA2-4.5NU](#) [UD2-4.5NE](#) [NL6448AC30-09](#) [UPA1572H](#) [RB06H2C12](#) [65LHS-3L](#) [EE2-5SNU](#) [MN41C4256A-07](#) [EE2-4.5SNUX](#) [EF2-1.5SNU](#) [MR62-5SR](#) [EC2-4.5NU](#) [EF2-4.5NUX](#) [EC2-12TNU](#) [EE2-5TNU](#) [EA2-3SNU](#) [NL6448AC20-06](#) [ED2-24NU](#) [EC2-24SNJ](#) [UPD70F3102GJ-A33-8EU](#) [UD2-5NU](#) [EB2-24TNU](#) [EE2-4.5NU](#) [EE2-3TNU](#) [UA2-1.5NU](#) [UB2-5SNU](#) [UB2-1.5NU](#) [UD2-4.5SNUN](#) [EE2-12NUH](#) [UA2-9NU](#) [UPD4218165G5-60-7JF](#) [EB2-24NU-L](#) [EP2-B3G1S-1-D](#) [EE2-4.5NUX](#) [UB2-4.5SNUN](#) [UB2-4.5SNU](#)