

# FIBER OPTIC SYSTEMS



opticalCON<sup>®</sup>  
Fiber optic connection system



**NEUTRIK<sup>®</sup>**

# SETTING STANDARDS



# Content

PAGE

<b>Introduction</b> .....	4
<b>opticalCON Design Criteria</b> .....	5
<b>opticalCON ADVANCED / LITE</b> .....	6
<b>opticalCON Chassis</b> .....	7
<b>opticalCON Mobile Field Cables</b> .....	8
<b>opticalCON Custom Cable Assembly</b> .....	10
<b>opticalCON ADVANCED Cable Connectors</b> .....	12
Features & Benefits .....	13
opticalCON DUO ADVANCED .....	14
opticalCON QUAD ADVANCED .....	16
opticalCON MTP® 12 ADVANCED .....	18
opticalCON MTP® 24 ADVANCED .....	20
opticalCON SPLIT & POWER SPLIT Cables .....	22
Breakout Adapter .....	24
Accessories for opticalCON ADVANCED .....	25
<b>opticalCON LITE Cable Connectors</b> .....	26
Features & Benefits .....	27
opticalCON DUO LITE .....	28
opticalCON QUAD LITE .....	30
opticalCON MTP® 12 LITE .....	32
opticalCON MTP® 24 LITE .....	34
<b>opticalCON ADVANCED Chassis Connectors</b> .....	36
Features & Benefits .....	37
opticalCON DUO ADVANCED Chassis .....	38
opticalCON QUAD ADVANCED Chassis .....	40
opticalCON MTP® 12 ADVANCED Chassis .....	42
opticalCON MTP® 24 ADVANCED Chassis .....	44
Accessories for Chassis .....	46
<b>opticalCON Coupler</b> .....	46
<b>opticalCON Transceiver Adapter</b> .....	47
<b>opticalCON Breakout Adapter</b> .....	47
<b>opticalCON Breakout Box</b> .....	48
<b>opticalCON powerMONITOR</b> .....	50
<b>opticalCON Panel Solutions</b> .....	52
<b>Fiber Optic Measurement &amp; Cleaning Kit</b> .....	54



# The applications for fiber are extensive



A few years ago, the use of fiber optic cabling in professional AV applications was limited to such special cases as HD broadcast cameras. Since then, the AV industry's adoption of fiber optics has increased immensely. Today, fiber optics are widely used for digital signal transmission in pro audio, professional broadcast, and the touring / rental industries. As pro audio and broadcast equipment has evolved from analog to digital data transmission, the industry has attempted to adapt connectors originally designed for data communication (e.g. RJ45 connectors for electrical transmission). Today, that trend continues with fiber optic connectors. However, conventional data communication fiber optic connectors (ST, SC, LC, etc.) have a risk of failure when they are deployed in AV applications. These conventional data connectors are optimized for permanent, one-time connection. They were never designed for mobile applications or to handle high mating cycles in harsh environments. Alternative connectors, originally developed for military applications, have not been cost effective and have been deficient either in regards to dust protection and

maintenance and/or in their attenuation and return loss characteristics.

Neutrik understood these deficiencies and solved the various issues associated with mobile fiber optic connectivity when it launched its opticalCON® fiber optic line in 2005. The opticalCON® design is based on a unique concept which combines low maintenance, high mating cycles, and a safe connection in the field. As a result, opticalCON® has gained wide acceptance in the pro audio and professional broadcast industries. Both well known equipment manufacturers and key industry users have put their trust in opticalCON® for many years.

## opticalCON®

# opticalCON® Design Criteria

The need for rugged fiber optic connections continues to grow rapidly, driven by such technologies as ultra high definition (UHD) 4K or 8K television signals running at data rates of up to 24 Gb/s. To accommodate these higher bandwidth signals, the Society of Motion Picture & Television Engineers (SMPTE) has standardized opticalCON® connectors as the rugged fiber optic interface for mobile high definition television broadcasting where robust and reliable solutions are required.

Neutrik's opticalCON® system became the fiber optic standard in various markets.



**SMPTE standard ST2091-1**

**opticalCON® ADVANCED DUO** is an LC-based fiber optic connection system which is typically used for equipment connections. With built-in, automatic dust shutters and a rugged housing, the fibers are always dust protected, and high mating cycles in harsh environments are achieved. Compatibility with conventional LC connectors at both the front and the rear of the chassis connectors offers users the choice of using either cost-effective, standard LC patch cables or else ruggedized opticalCON cables.

Following on the success of opticalCON ADVANCED DUO, the **opticalCON® ADVANCED QUAD** series, also an LC-based connector system, doubles the fiber count to offer a rugged point-to-point connection. opticalCON® QUAD has been successfully deployed in applications such as data routing for touring / live rental, including especially OB (outdoor broadcast) applications.

**opticalCON® ADVANCED MTP®** increases the number of fibers in one connector up to 24 and is the ideal solution for point-to-point multi-fiber signal transmission.

As an alternative to opticalCON MTP's single 12 or 24-fiber connector, Neutrik offers a wide variety of SPLIT cable configuration. opticalCON® SPLIT offers an alternative for users of opticalCON® DUO or QUAD chassis connectors, providing advantages in regards to field assembly and potential repair cost.

Finally, Neutrik's **opticalCON® LITE** connectors offer a cost effective and lightweight solution. The unique design of opticalCON® LITE's tactical patch cable allows extreme bending without fiber breakage and absorbs high lateral forces. As a result, the opticalCON® LITE is an ideal choice for such permanent and semi-permanent installations as server rooms, patch fields, and indoor cabling.

# opticalCON® Cable Connectors

## opticalCON® LITE



## opticalCON® ADVANCED



# opticalCON®

## Chassis Connectors



### opticalCON® DUO

2-channel fiber optic connection system



### opticalCON® QUAD

4-channel fiber optic connection system



### opticalCON® MTP® 12

12-channel fiber optic connection system



### opticalCON® MTP® 24

24-channel fiber optic connection system

# opticalCON®

## Mobile Field Cable Range

### ADVANCED Cable

#### opticalCON DUO

Rugged and lightweight 2-channel mobile field cable, excellent cable retention due to aramid yarn, black PUR outer jacket, available in multi- and single mode (PC or APC), military approved.

#### opticalCON DUO X-TREME

2-channel X-TREME cable offering a cut-proof and rodent resistant double jacket glass yarn armoured cable construction, excellent cable retention due to aramid yarn, black PUR outer jacket.

#### opticalCON DUO ARMORED

Extra rugged and lightweight stainless steel, jacket absorbs lateral forces up to 200 kg/cm<sup>2</sup>. Ultra flexible due to the special spring shape construction, available in multi- and single mode (PC or APC).

#### opticalCON DUO HYBRID

Extra rugged hybrid cable with 2 multimode channels and 4 x 0.75 mm<sup>2</sup> copper conductors, GFK strength member and aramid yarn as cable retention.

#### opticalCON DUO SMPTE

SMPTE cable with 2 single mode channels (PC or APC), 2 x AWG 24 and 4 x AWG 20 stranded copper conductors, overall copperbraided shield and stainless steel strength member, 120 kg/km.

#### opticalCON DUO LOW VOLTAGE HYBRID

Ultra flexible, cost effective and lightweight (65 kg/km) low voltage hybrid cable with 2 single mode channels and 2 x AWG 16 copper conductors, aramid yarn cable retention.

2M / 2S (A)



X2M / X2S (A)

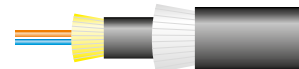

XX2M / XX2S (A)

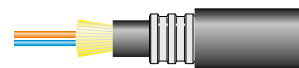

H1

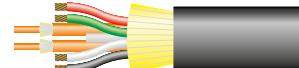

S1 (A)

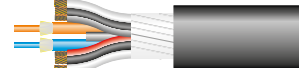

S5 (A)

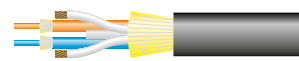

#### opticalCON QUAD

Rugged and lightweight 4-channel mobile field cable, excellent cable retention due to aramid yarn, black PUR outer jacket, available in multi- and single mode (PC or APC).

#### opticalCON QUAD X-TREME

4-channel X-TREME cable offering a cut-proof and rodent resistant double jacket glass yarn armoured cable construction, excellent cable retention due to aramid yarn, black PUR outer jacket.

#### opticalCON QUAD ARMORED

Extra rugged and lightweight stainless steel jacket absorbs lateral forces of 200 kg/cm<sup>2</sup>. Ultra flexible due to the special spring shape construction, available in multi- and single mode (PC or APC).

4M / 4S (A)



X4M / X4S (A)



XX4M / XX4S (A)

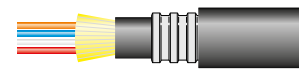



### opticalCON MTP® 12 & SPLIT

Rugged and lightweight 12-channel mobile field cable, excellent cable retention due to aramid yarn, black PUR outer jacket, available in multimode PC and singlemode APC.

### opticalCON MTP® 24 & SPLIT

24-channel mobile field cable with excellent cable PUR outer jacket, available in multimode PC and singlemode APC.

### opticalCON MTP® 12 X-TREME & SPLIT

12-channel X-TREME cable offering a cut-proof and rodent resistant double jacket glass yarn armoured cable construction, excellent cable retention due to aramid yarn, black PUR outer jacket.

### opticalCON POWER-SPLIT

Extra rugged hybrid cable up to 8 single mode channels and 2 x 1.5 mm<sup>2</sup> copper conductors, 1.5 mm<sup>2</sup> shield, 2 opticalCON cable connectors and 1 powerCON cable connector.

12M / 12S (A)



24M / 24S (A)



X12M / X12S (A)

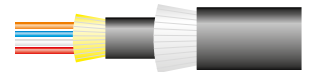

P8M / P8S (A)

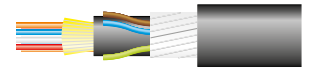

## LITE Cable

### opticalCON DUO LITE

Rugged and lightweight 2-channel patch cable, excellent cable retention due to aramid yarn, black PVC outer jacket, available in multi- and singlemode (PC or APC), suitable for permanent and temporary installation.

2M-L / 2S (A)



### opticalCON QUAD LITE

Lightweight tactical patch cable, 4 x 900/125 micron fibers, rugged cable retention due to aramid yarn, black PVC outer jacket, available in multi- and singlemode (PC or APC), designed for permanent or semi-permanent installations.

4M-L / 4S (A)



### opticalCON MTP® 12 LITE

Rugged tactical patch cable, 12x 250/125 micron fibers, aramid yarn for appropriate cable retention, black PVC outer jacket, available in multimode PC and singlemode (APC), suitable for permanent or semi-permanent installations.

12M-L / 12SA



### opticalCON MTP® 24 LITE

Rugged tactical patch cable, 24 x 250/125 micron fibers, aramid yarn for appropriate cable retention, black PVC outer jacket, available in multimode PC and singlemode (APC), suitable for permanent or semi-permanent installations.

24M-L / 12SA



# opticalCON® Custom Cable Assembly

## opticalCON® ADVANCED



## opticalCON® LITE



## opticalCON® Split





1

### Rubber protection cover

Noise cancelling rubber protection cover for opticalCON cable connectors, including front housing.



2

### Custom color coding

Color coding ring for opticalCON cable connectors.



3

### Crossed fiber wiring (A-A), (B-B)



Neutrik standard: wiring acc. IEC 11801

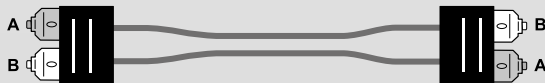

4

### Power IN / OUT

With the Neutrik powerCON mains connector NAC3MX-W-TOP (IN) / NAC3FX-W-TOP (OUT).



NAC3MX-W-TOP



NAC3FX-W-TOP

5

### Breakout assembly

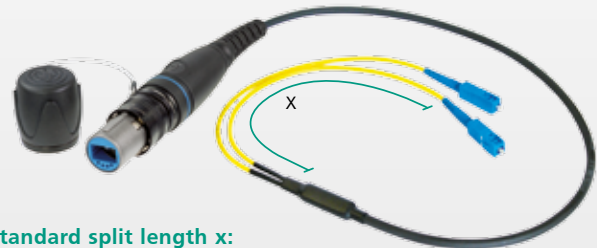

#### Standard split length x:

DUO/QUAD	30 cm (1 ft.)
MTP 12	60 cm (2 ft.)
MTP 24	1 m (3 ft.)

6

### Custom cable & Split text labeling

- Custom labeling
- 1 or 2 lines
- Split text to color

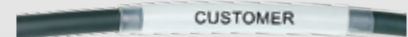

7

### Female assembly on cable drums

Cable extension solution eliminating the need for couplers.



8

### Custom split length

Standard: length 1 m

9

### Stepped split assembly

Standard: equal split length

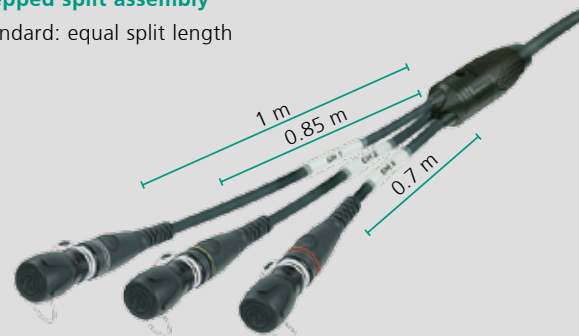

# opticalCON<sup>®</sup> ADVANCED CABLE CONNECTORS





# Features & Benefits

Mobile use

Rugged

Low maintenance

High performance



## opticalCON DUO

## opticalCON QUAD

## opticalCON MTP 12

## opticalCON MTP 24



NKO2S-A\*

- 2 fibers
- 4 copper contacts



NKO4S-A\*

- 4 fibers



NKO12SA\*

- 12 fibers



NKO24SA\*

- 24 fibers



# opticalCON® DUO ADVANCED

## Cable Connector Assembly



- Ruggedized and dirt-protected 2-channel fiber optic connection system
- Cable connector features rugged metal housing and heavy-duty cable retention
- Automatic sealing shutter with silicone gasket to protect the LC's
- Dust and water resistant according to IP65 in mated condition
- Accommodates standard optical LC-Duplex connectors
- Field repairable
- Easy to clean, no special tools required
- Reliable Push-Pull locking mechanism
- Cable connector comes pre-assembled with a choice of mobile field cables
- Range of 3 hybrid cables for powered applications:
  - SMPTE cable for indoor UHD camera routing applications<sup>1</sup>
  - Hybrid multimode cable
  - Light weight low voltage camera / SM hybrid cable for ENG / SNG applications

<sup>1</sup>... Not compatible to SMPTE 304M standard. Suitable for indoor (studio) camera links considering specific conditions acc. to IEC 60664-1 like pollution degree 1, overvoltage category 1 and rated voltage. For detailed information ask for the White Paper "opticalCON @ SMPTE Indoor Applications".

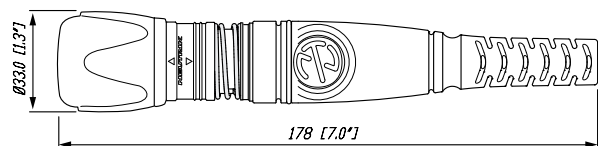
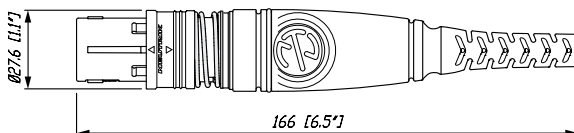

# Technical Data

## Technical Data Optical Cable Connector

Optical connector	LC-Duplex	
Fiber	Multimode, Singlemode PC / APC	•
Insertion loss	< 0.45 dB / connection	•
min. Return loss	MM PC > 25 dB	•
	SM PC > 50 dB	•
	SM APC > 60 dB	•

## MECHANICAL

Insertion / withdrawal force	< 45 N	•
Lifetime (mating cycles)	> 5'000	•
Cable retention force	Fiber only > 500 N	•
	Hybrid > 500 N	•
	SMPTE > 500 N	•

## ELECTRICAL

Number of electrical contacts	4	
Rated current	6 A	NKO2M-H1
	contact 1+4 10 A	NKO2S(A)-S1
Contact resistance	< 7 mΩ	•
Insulation resistance	- initial: > 10 GΩ	•
	- after damp heat test: > 1 GΩ	•
Dielectric strength	1500 V dc	•
Rated voltage	50 V ac	• <sup>1</sup>

## MATERIAL

Shell	Zinc diecast (ZnAl4Cu1), black chrome plating	•
Insert / Insulation	Polyamid PA 6, PBT 30% GR, PBT 50% GR	•
Insert colour	MM: black, SM PC: blue, SM APC: green	•
Contacts	- male: Brass (CuZn39Pb3)	•
Contact surface	Gold (gal 0.2 μm Au over 2 μm Ni)	•
Strain relief	Brass, Ni plated	•
Bushing	ZnAl4Cu1	•
Boot	EPDM, rubber boot	•

## ENVIRONMENTAL

Operating temp.	-40°C to +75°C	•
Flammability	UL94 HB	•
Solderability	complies with IEC 68-2-20	•
Protection class	in mated condition IP65	•

<sup>1</sup> ... Not compatible to SMPTE 304M standard. Suitable for indoor (studio) camera links considering specific conditions acc. to IEC 60664-1 like pollution degree 1, overvoltage category 1 and rated voltage. For detailed information ask for the White Paper "opticalCON @ SMPTE Indoor Applications".

## Technical Data Cables

	2M	2S (A)	2M-H1	2S (A) - S1	2S (A) - S5	X2M	X2S (A)	XX2M	XX2S (A)
Max. number of fibers	2	2	2	2	2	2	2	2	2
Mode - Multimode PC	•	-	•	-	-	•	-	•	-
- Single mode PC / APC	-	•	-	•	•	-	•	-	•
Fiber - 50 / 125-OM3	•	-	•	-	-	•	-	•	-
- 9 / 125-G657A2	-	•	-	•	•	-	•	-	•
Bend optimized fiber	•	•	-	•	•	•	•	•	•
Laser optimized fiber	•	N/A	-	N/A	N/A	•	N/A	•	N/A
Copper wires									
- AWG 16	-	-	-	-	2x	-	-	-	-
- AWG 18 (0.75 mm <sup>2</sup> )	-	-	4x	-	-	-	-	-	-
- AWG 20	-	-	-	4x	-	-	-	-	-
- AWG 24	-	-	-	2x	-	-	-	-	-
Outer shield									
- Copper braid	-	-	-	•	-	-	-	-	-
- Coated glass yarn	-	-	-	-	-	•	•	-	-
- Stainless steel Jacket	-	-	-	-	-	-	-	•	•
Strength member									
- GFK	-	-	•	-	-	-	-	-	-
- Stainless Steel	-	-	-	•	-	-	-	-	-
Cable retention									
- Aramid yarn	•	•	•	-	•	•	•	•	•
- Crimp type	-	-	-	•	-	-	-	-	-
Overall diameter (mm)	5.0	5.0	8.9	9.2	7.3	9.2	9.2	10.5	10.5
Jacket - PUR black matte	•	•	•	•	•	•	•	•	•
Optical connector									
- LC-Duplex	•	•	•	•	•	•	•	•	•
- LC based	-	-	-	-	-	-	-	-	-
Min. bending radius (cm)	5.0	5.0	8.9	10.0	7.5	9.2	9.2	10.5	10.5
Weight (kg / km)	21	23	78	120	65	79	79	131	133
Attenuation (dB / km)	@ 850 nm - 3.5 @ 1310 nm - 1.5	@ 850 nm - 3.5 @ 1310 nm - 1.5	@ 850 nm - 2.5 @ 1300 nm - 0.7	@ 1310 nm - 0.45 @ 1550 nm - 0.5	@ 1310 nm - 0.5 @ 1550 nm - 0.5	@ 850 nm - 2.5 @ 1300 nm - 0.5	@ 1310 nm - 0.35 @ 1550 nm - 0.21	@ 850 nm - 3.5 @ 1300 nm - 1.5	@ 1310 nm - 0.5 @ 1550 nm - 0.5
Bandwidth (MHz-km)	@ 850 nm > 1500 @ 1310 nm > 500	@ 850 nm > 1500 @ 1310 nm > 500	@ 850 nm > 500 @ 1300 nm > 500	@ 1310 nm - 1.468 @ 1550 nm - 1.468	@ 1310 nm - 1.468 @ 1550 nm - 1.468	@ 850 nm - 1.482 @ 1300 nm - 1.477	@ 850 nm - 1.467 @ 1550 nm - 1.467	@ 850 nm - 1.483 @ 1300 nm - 1.479	@ 1310 nm - 1.468 @ 1550 nm - 1.468
Refraction index	@ 850 nm - 1.483 @ 1310 nm - 1.479	@ 850 nm - 1.483 @ 1310 nm - 1.479	@ 850 nm - 1.482 @ 1300 nm - 1.477	@ 1310 nm - 1.468 @ 1550 nm - 1.468	@ 1310 nm - 1.468 @ 1550 nm - 1.468	@ 850 nm - 1.482 @ 1300 nm - 1.477	@ 850 nm - 1.467 @ 1550 nm - 1.467	@ 850 nm - 1.483 @ 1300 nm - 1.479	@ 1310 nm - 1.468 @ 1550 nm - 1.468
Power solution	240V ac / 16A	-	-	-	-	-	-	-	-

Ordering & Packaging options with max. cable length see on the part number generator - [www.neutrik.com](http://www.neutrik.com)



- 0... Airspool
- 1... opticalCON Case
- 2... Drum Schill GT310
- 3... Drum Schill GT380
- 4... Drum Schill HT582
- 5... Drum Schill GT450
- 6... Drum Schill SK4812



# opticalCON® QUAD ADVANCED

## Cable Connector Assembly



NKO4S-A\*

- Ruggedized and dirt-protected 4-channel fiber optic connection system
- For point-to-point multichannel routing
- Cable connector features rugged all-metal housing and heavy-duty cable retention
- Innovative special shutter guarantees low maintenance
- Dust and water resistant according to IP65 in mated condition
- Easy to clean, no special tools required
- Reliable Push-Pull locking mechanism
- Cable connector comes pre-assembled with a choice of mobile field cables
- Field repairable

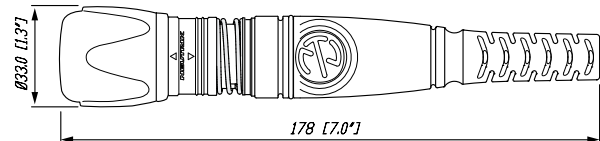
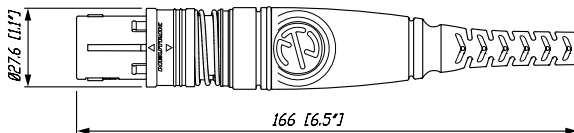



# Technical Data

## Technical Data Optical Cable Connector

Optical connector	PC
Fiber	Multimode, Singlemode PC / APC
Insertion loss	< 0.45 dB / connection
min. Return loss	MM PC > 25 dB
	SM PC > 50 dB
	SM APC > 60 dB

## MECHANICAL

Insertion / withdrawal force	< 45 N
Lifetime (mating cycles)	> 5'000
Cable retention force	Fiber only > 500 N

## MATERIAL

Shell	Zinc diecast (ZnAl4Cu1), black chrome plating
Insert / Insulation	Polyamid PA 6, PBT 30% GR, PBT 50% GR
Insert colour	MM: black, SM PC: blue, SM APC: green
Strain relief	Brass, Ni plated
Bushing	ZnAl4Cu1
Boot	EPDM, rubber boot

## ENVIRONMENTAL

Operating temp.	-40°C to +75°C
Flammability	UL94 HB
Protection class	in mated condition IP65

## Technical Data Cables

	4M	4S (A)	X4M	X4S (A)	XX4M	XX4S (A)
Max. number of fibers	4	4	4	4	4	4
Mode - Multimode PC	●	-	●	-	●	-
- Single mode PC / APC	-	●	-	●	-	●
Fiber - 50 / 125-OM3	●	-	●	-	●	-
- 9 / 125-G657A2	-	●	-	●	-	●
Bend optimized fiber	●	●	●	●	●	●
Laser optimized fiber	●	N/A	●	N/A	●	N/A
Outer shield						
- Copper braid	-	-	-	-	-	-
- Coated glass yarn	-	-	●	●	-	-
- Stainless steel Jacket	-	-	-	-	●	●
Strength member						
- GFK	-	-	-	-	-	-
- Stainless Steel	-	-	-	-	-	-
Cable retention						
- Aramid yarn	●	●	●	●	●	●
- Crimp type	-	-	-	-	-	-
Overall diameter (mm)	5.8	5.8	9.2	9.2	10.5	10.5
Jacket - PUR black matte	●	●	●	●	●	●
Optical connector						
- LC-Duplex	-	-	-	-	-	-
- LC based	●	●	●	●	●	●
Min. bending radius (cm)	5.8	5.8	9.2	9.2	10.5	10.5
Weight (kg / km)	31	31	88	88	141	141
Attenuation (dB / km)	@ 850 nm - 2.5 @ 1300 nm - 0.5	@ 1310 nm - 0.35 @ 1550 nm - 0.21	@ 850 nm - 2.5 @ 1300 nm - 0.5	@ 1310 nm - 0.35 @ 1550 nm - 0.21	@ 850 nm - 2.5 @ 1300 nm - 0.5	@ 1310 nm - 0.35 @ 1550 nm - 0.21
Bandwidth (MHz-km)	@ 850 nm ≥ 1500 @ 1300 nm ≥ 500		@ 850 nm ≥ 1500 @ 1300 nm ≥ 500		@ 850 nm ≥ 1500 @ 1300 nm ≥ 500	
Refraction index	@ 850 nm - 1.482 @ 1300 nm - 1.477	@ 1310 nm - 1.467 @ 1550 nm - 1.467	@ 850 nm - 1.482 @ 1300 nm - 1.477	@ 1310 nm - 1.467 @ 1550 nm - 1.467	@ 850 nm - 1.482 @ 1300 nm - 1.477	@ 1310 nm - 1.467 @ 1550 nm - 1.467

## Packaging options and max. cable length see on the part number generator - [www.neutrik.com](http://www.neutrik.com)

<b>0</b>	<b>1</b>	<b>2</b>	<b>3</b>	<b>4</b>	<b>5</b>	<b>6</b>	
							<ul style="list-style-type: none"> <li>-0... Airspool</li> <li>-1... opticalCON Case</li> <li>-2... Drum Schill GT310</li> <li>-3... Drum Schill GT380</li> <li>-4... Drum Schill HT582</li> <li>-5... Drum Schill GT450</li> <li>-6... Drum Schill SK4812</li> </ul>



# opticalCON® MTP® 12 ADVANCED Cable Connector Assembly



NK012SA-A\*

- Ruggedized and dirt-protected 12-channel fiber optic connection system
- For point-to-point multichannel routing based on MTP® technology
- Cable connector features rugged metal housing and heavy-duty cable retention
- Spherical shutter guarantees low maintenance
- Dust and water resistant according to IP65 in mated condition
- Easy to clean, no special tools required
- Reliable Push-Pull locking mechanism
- Cable connector comes pre-assembled with a choice of mobile field cables
- Wiring Type A

The MTP® is a multichannel fiber optic connector based on MPO (“Multifiber Push On”) technology (IEC-61754-7). Breakout / Master cables to standard connectors as LC, SC, ST are available in various length.

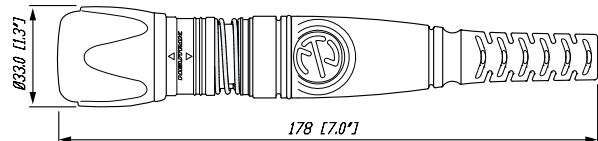
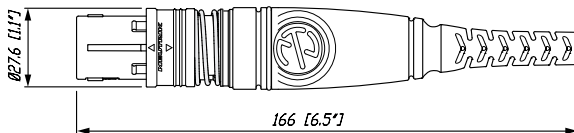

\* ... MTP® is a trademark of US Conec ([www.usconec.com](http://www.usconec.com))

# Technical Data

## Technical Data Optical Cable Connector

Optical connector	MTP®	female
Fiber	Multimode, Singlemode APC	•
Insertion loss	< 0.9 dB / connection	•
min. Return loss	MM PC > 25 dB	•
	SM APC > 60 dB	•
Wiring	Type A	•

## MECHANICAL

Insertion / withdrawal force	< 45 N	•
Lifetime (mating cycles)	> 2'500	•
Cable retention force	Fiber only > 500 N	•

## MATERIAL

Shell	Zinc diecast (ZnAl4Cu1), black chrome plating	•
Insert / Insulation	PA 6	•
	POM, PC, PEI	
Insert colour	MM: black, SM PC: blue, SM APC: green	•
Strain relief	Brass, Ni plated	•
Bushing	ZnAl4Cu1	•
Boot	EPDM, rubber boot	•

## ENVIRONMENTAL

Operating temp.	-40°C to +75°C	•
Flammability	UL94 HB	•
Protection class	in mated condition IP65	•

## Technical Data Cables

	12M	12SA	X12M	X12SA
Max. number of fibers	12	12	12	12
Mode - Multimode PC	•	-	•	-
- Single mode PC / APC	-	•	-	•
Fiber - 50 / 125-OM3	•	-	•	-
- 9 / 125-G657A2	-	•	-	•
Bend optimized fiber	•	•	•	•
Laser optimized fiber	•	N/A	•	N/A
Outer shield				
- Copper braid	-	-	-	-
- Coated glass yarn	-	-	•	•
- Stainless steel Jacket	-	-	-	-
Strength member				
- GFK	-	-	-	-
- Stainless Steel	-	-	-	-
Cable retention				
- Aramid yarn	•	•	•	•
- Crimp type	-	-	-	-
Overall diameter (mm)	8.2	8.2	10.9	10.9
Jacket - PUR black matte	•	•	•	•
Optical connector				
- LC-Duplex	-	-	•	•
- LC based	•	•	•	•
Min. bending radius (cm)	8.2	8.2	10.9	10.9
Weight (kg / km)	60	60	103	103
Attenuation (dB / km)	@850 nm - 2.5 @1300 nm - 0.5	@1310 nm - 0.5 @1550 nm - 0.3	@850 nm - 2.5 @1300 nm - 0.5	@1310 nm - 0.5 @1550 nm - 0.3
Bandwidth (MHz-km)	@850 nm ≥1500 @1300 nm ≥500		@850 nm ≥1500 @1300 nm ≥500	
Refraction index	@850 nm - 1.482 @1300 nm - 1.477	@1310 nm - 1.467 @1550 nm - 1.467	@850 nm - 1.482 @1300 nm - 1.477	@1310 nm - 1.467 @1550 nm - 1.467

## Packaging options and max. cable length see on the part number generator - [www.neutrik.com](http://www.neutrik.com)

<b>0</b>	<b>1</b>	<b>2</b>	<b>3</b>	<b>4</b>	<b>5</b>	<b>6</b>															
																					
							<table border="1"> <tr> <td>-0...</td> <td>Airspool</td> </tr> <tr> <td>-1...</td> <td>opticalCON Case</td> </tr> <tr> <td>-2...</td> <td>Drum Schill GT310</td> </tr> <tr> <td>-3...</td> <td>Drum Schill GT380</td> </tr> <tr> <td>-4...</td> <td>Drum Schill HT582</td> </tr> <tr> <td>-5...</td> <td>Drum Schill GT450</td> </tr> <tr> <td>-6...</td> <td>Drum Schill SK4812</td> </tr> </table>	-0...	Airspool	-1...	opticalCON Case	-2...	Drum Schill GT310	-3...	Drum Schill GT380	-4...	Drum Schill HT582	-5...	Drum Schill GT450	-6...	Drum Schill SK4812
-0...	Airspool																				
-1...	opticalCON Case																				
-2...	Drum Schill GT310																				
-3...	Drum Schill GT380																				
-4...	Drum Schill HT582																				
-5...	Drum Schill GT450																				
-6...	Drum Schill SK4812																				



# opticalCON® MTP® 24 ADVANCED Cable Connector Assembly



NKO24M-A\*

- Ruggedized and dirt-protected 24-channel fiber optic connection system
- For point-to-point multichannel routing based on MTP® technology
- Cable connector features rugged metal housing and heavy-duty cable retention
- Spherical shutter guarantees low maintenance
- Dust and water resistant according to IP65 in mated condition
- Easy to clean, no special tools required
- Reliable Push-Pull locking mechanism
- Cable connector comes pre-assembled with a choice of mobile field cables
- Wiring Type A

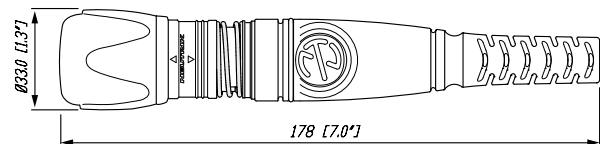
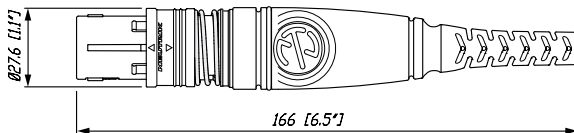

\* ... MTP® is a trademark of US Conec ([www.usconec.com](http://www.usconec.com))

# Technical Data

## Technical Data Optical Cable Connector

Optical connector	MTP® female	
Fiber	Multimode, Singlemode APC	●
Insertion loss	< 0.9 dB / connection	●
min. Return loss	MM PC > 25 dB	●
	SM APC > 60 dB	●
Wiring	Type A	●

### MECHANICAL

Insertion / withdrawal force	< 45 N	●
Lifetime (mating cycles)	> 2'500	●
Cable retention force	Fiber only > 500 N	●

### MATERIAL

Shell	Zinc diecast (ZnAl4Cu1), black chrome plating	●
Insert / Insulation	PA 6 POM, PC, PEI	●
Insert colour	MM: black, SM PC: blue, SM APC: green	●
Strain relief	Brass, Ni plated	●
Bushing	ZnAl4Cu1	●
Boot	EPDM, rubber boot	●

### ENVIRONMENTAL

Operating temp.	-40°C to +75°C	●
Flammability	UL94 HB	●
Protection class	in mated condition IP65	●

## Technical Data Cables

	24M	24SA
Max. number of fibers	24	24
Mode - Multimode PC	●	-
- Single mode PC / APC	-	●
Fiber - 50 / 125-OM3	●	-
- 9 / 125-G657A2	-	●
Bend optimized fiber	●	●
Laser optimized fiber	●	N/A
Outer shield		
- Copper braid	-	-
- Coated glass yarn	-	-
- Stainless steel Jacket	-	-
Strength member		
- GFK	-	-
- Stainless Steel	-	-
Cable retention		
- Aramid yarn	●	●
- Crimp type	-	-
Overall diameter (mm)	7.0	7.0
Jacket - PUR black matte	●	●
Optical connector		
- LC-Duplex	-	-
- LC based	●	●
Min. bending radius (cm)	8.2	8.2
Weight (kg / km)	43	43
Attenuation (dB / km)	@850 nm - 2.5 @1300 nm - 0.5	@1310 nm - 0.5 @1550 nm - 0.3
Bandwidth (MHz-km)	@850 nm ≥ 1500 @1300 nm ≥ 500	
Refraction index	@850 nm - 1.482 @1300 nm - 1.477	@1310 nm - 1.467 @1550 nm - 1.467

Packaging options and max. cable length see on the part number generator - [www.neutrik.com](http://www.neutrik.com)

<b>0</b>	<b>1</b>	<b>2</b>	<b>3</b>	<b>4</b>	<b>5</b>	<b>6</b>		
							-0... Airspool	
							-1... opticalCON Case	
							-2... Drum Schill GT310	
							-3... Drum Schill GT380	
							-4... Drum Schill HT582	
							-5... Drum Schill GT450	
							-6... Drum Schill SK4812	

# opticalCON® Split Cables

## SPLIT & POWER SPLIT Cables

opticalCON®

### SPLIT



NKOY\*

- opticalCON multichannel solution based on opticalCON DUO, QUAD or MTP® connectors
- Maximum flexibility, combining up to 12-channel
- Custom configurations available
- 1m SPLIT fanout
- Color coding for channel identification
- Field assembly possible
- XTREME version available

opticalCON®

### POWER-SPLIT



NKOYP\*

- 2-, 4-, 6- and 8-channel assembly available
- Custom made cable, optimized for ENG / SNG applications
- Hybrid fiber / copper solution
- Custom Configurations
- Up to 240 V ac (16 A) power transportation possible

# Technical Data

## Technical Data Optical Cable Connector

Optical connector	PC	
Fiber	Multimode, Singlemode PC / APC	●
Insertion loss	< 0.45 dB / connection	●
min. Return loss	MM PC > 25 dB	●
	SM PC > 50 dB	●
	SM APC > 60 dB	●

## MECHANICAL

Insertion / withdrawal force	< 45 N	●
Lifetime (mating cycles)	> 5'000	●
Cable retention force	Fiber only > 500 N	●

## MATERIAL

Shell	Zinc diecast (ZnAl4Cu1), black chrome plating	●
Insert / Insulation	Polyamid PA 6, PBT 30% GR, PBT 50% GR	●
Insert colour	MM: black, SM PC: blue, SM APC: green	●
Strain relief	Brass, Ni plated	●
Bushing	ZnAl4Cu1	●
Boot	EPDM, rubber boot	●

## ENVIRONMENTAL

Operating temp.	-40°C to +75°C	●
Flammability	UL94 HB	●
Protection class	in mated condition IP65	●

## Technical Data Cables

	12M	12S (A)	X12M	X12S (A)	P8M	P8S (A)
Max. number of fibers	12	12	12	12	8	8
Mode - Multimode PC	●	-	●	-	●	-
- Single mode PC / APC	-	●	-	●	-	●
Fiber - 50 / 125-OM3	●	-	●	-	●	-
- 9 / 125-G657A2	-	●	-	●	-	-
Bend optimized fiber	●	●	●	●	●	●
Laser optimized fiber	●	N/A	●	N/A	●	N/A
Copper wires						
- 3 x 1.5 mm <sup>2</sup>	-	-	-	-	●	●
Outer shield						
- Copper braid	-	-	-	-	●	●
- Coated glass yarn	-	-	●	●	-	-
- Stainless steel Jacket	-	-	-	-	-	-
Strength member						
- GFK	-	-	-	-	-	-
- Stainless Steel	-	-	-	-	-	-
Cable retention						
- Aramid yarn	●	●	●	●	●	●
- Crimp type	-	-	-	-	-	-
Overall diameter (mm)	8.2	8.2	10.9	10.9	11.7	11.7
Jacket - PUR black matte	●	●	●	●	●	●
Optical connector						
- LC-Duplex	-	-	●	●	●	●
- LC based	●	●	●	●	●	●
Min. bending radius (cm)	8.2	8.2	10.9	10.9	12.1	12.1
Weight (kg / km)	60	60	103	103	138	138
Attenuation (dB / km)	@850 nm - 2.5 @1300 nm - 0.5	@1310 nm - 0.5 @1550 nm - 0.3	@850 nm - 2.5 @1300 nm - 0.5	@1310 nm - 0.5 @1550 nm - 0.3	@850 nm ≤ 2.3 @1300 nm ≤ 0.6	@1310 nm ≤ 0.33 @1550 nm ≤ 0.19
Bandwidth (MHz-km)	@850 nm ≥ 1500 @1300 nm ≥ 500		@850 nm ≥ 1500 @1300 nm ≥ 500		@850 nm ≥ 1500 @1300 nm ≥ 500	
Refraction index	@850 nm - 1.482 @1300 nm - 1.477	@1310 nm - 1.467 @1550 nm - 1.467	@850 nm - 1.482 @1300 nm - 1.477	@1310 nm - 1.467 @1550 nm - 1.467	@850 nm - 1.482 @1300 nm - 1.477	@1310 nm - 1.467 @1550 nm - 1.467
Power solution 240V ac/16A	-	-	-	-	●*	●*

\* Cable must be unreeled completely before use!

Packaging options and max. cable length see on the part number generator - [www.neutrik.com](http://www.neutrik.com)



- 0... Airspool
- 1... opticalCON Case
- 2... Drum Schill GT310
- 3... Drum Schill GT380
- 4... Drum Schill HT582
- 5... Drum Schill GT450
- 6... Drum Schill SK4812



# Ordering Information

## Breakout Adapter

### MTP® Breakout / Master Cable

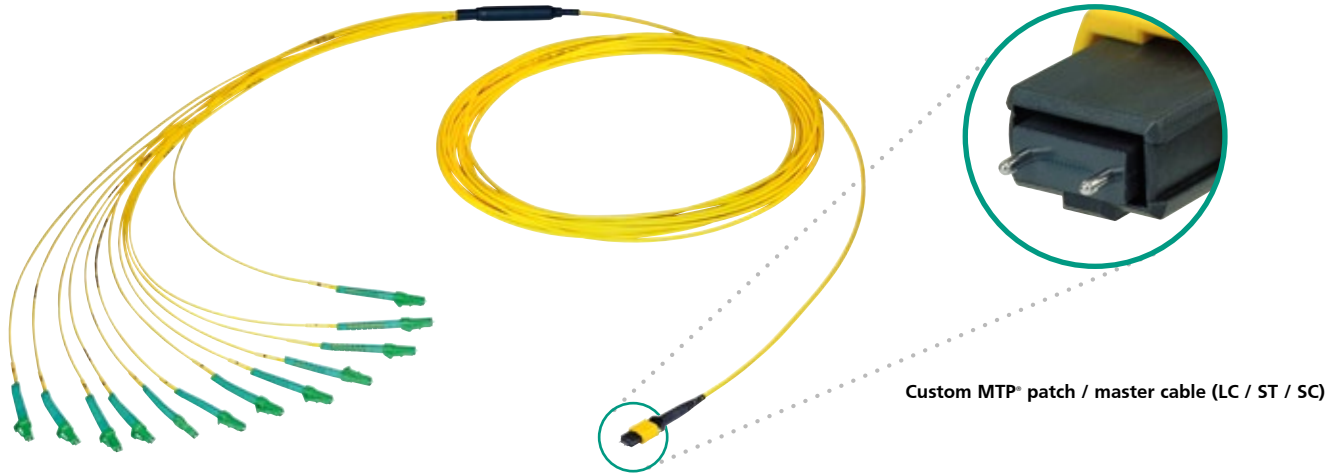

- Low loss breakout cable
- Grade A premium ferrules
- LC (APC) / SC, ST breakout connector available
- Standard split length: 61 cm
- High performance USCONEC Elite® Male MTP® ferrule
- Interferometer measurement to guarantee high ferrule performance

High performance MTP® breakout cable for permanent and temporary installations. Standard premium grade A LCs (single-mode PC; multimode PC) guarantee low insertion loss values. 61 cm long fan-out for easy fiber breakout to any opticalCON DUO or QUAD chassis.

NKOB12SA-A-0-**	MTP® 12 / LC - patch cable, Singlemode PC
NKOB12M-A-0-**	MTP® 12 / LC - patch cable, Multimode PC
NKOB24SA-A-0-**	MTP® 24 / LC - patch cable, Singlemode PC
NKOB24M-A-0-**	MTP® 24 / LC - patch cable, Multimode PC

#### Attribute:

BO [ ]	... breakout connectors (ST, SC), APC on request
*	... Fiber optic transmission parameters exceeding standard quality, suitable for measurement applications.
Notice:	Standard for out configuration comes with LC (PC) connectors.





# Accessories

## Accessories for Cable Connector



SCNO\*X-A



SCNO\*X-A-NC



NAO4ML-A



NOR-\*

SCNO*X-A	Rubber coated protection cover for opticalCON cable connectors, including black chrome front housing
SCNO*X-A-NC	Light weight noise cancelling rubber protection cover for opticalCON cable connectors, including front housing
SCNO*X-R <sup>1)</sup>	Rubber coated protection cover for opticalCON cable connectors, ruthenium plated front housing, upgrade kit old connector
NOR-*	Color coding ring for cable connector chassis
NAO4ML-A	opticalCON QUAD LOOP connector, multimode
NAO4SL-A	opticalCON QUAD LOOP connector, singlemode

\*: 0- black, 1- brown, 2- red, 3-orange, 4- yellow, 5- green, 6- blue, 7- violet, 8- grey, 9- white



<sup>1)</sup>: find part numbers on [www.neutrik.com](http://www.neutrik.com)

## opticalCON Pulling Solutions

Single pulling sock  
FOPS-SINGLE



Split pulling sock  
FOPS-SPLIT



Application example: FOPS-SPLIT

- Pulling sock simplifies installation
- Pulling force > 100 kg
- Protects connectors in mated / unmated condition

FOPS-SPLIT	Split cable pulling sock
FOPS-SINGLE	Single cable pulling sock for DUO / QUAD or MTP® cables.

# opticalCON<sup>®</sup> LITE CABLE CONNECTORS





# Features & Benefits

- Small form factor
- Tactical patch cable
- Safe connection
- Cost effective



opticalCON DUO LITE	opticalCON QUAD LITE	opticalCON MTP® 12 LITE	opticalCON MTP® 24 LITE
 <p>NKO2M-L*</p>  <ul style="list-style-type: none"><li>• 2 x 1.25 mm LC-ferrules</li></ul>	 <p>NKO4M-L*</p>  <ul style="list-style-type: none"><li>• 4 x 1.25 mm LC-ferrules</li></ul>	 <p>NKO12M-L*</p>  <ul style="list-style-type: none"><li>• 12 fiber - MTP® ferrule</li></ul>	 <p>NKO24M-L*</p>  <ul style="list-style-type: none"><li>• 24 fiber - MTP® ferrule</li></ul>



# opticalCON® DUO LITE Cable Connector Assembly



NKO2M-L\*

- 2-channel fiber optic connection system
- Cost optimized fiber connection for semi and permanent installations
- Waterproof acc. to IP65 safety standard in mated condition
- Small form factor
- Push-Pull locking mechanism for save connection
- Easy to clean, no special tools required
- Compatible with standard opticalCON DUO chassis NO2-4FDW-A\*

## Tactical Patch Cable

Conventional patch cables are sensitive in terms of under cutting the minimum bending radius and lateral pressure. Neutrik's tactical patch cables feature unique fiber design including a protection buffer which allows bendings with minimal radius and increased lateral pressure. Therefore the tactical patch cables are the right choice for permanent or semi-permanent applications.

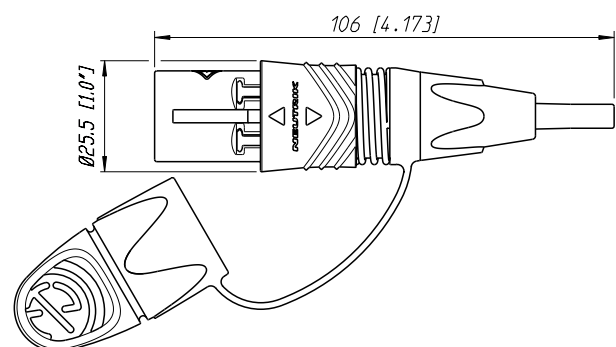
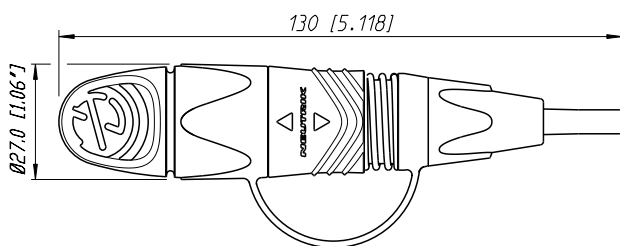
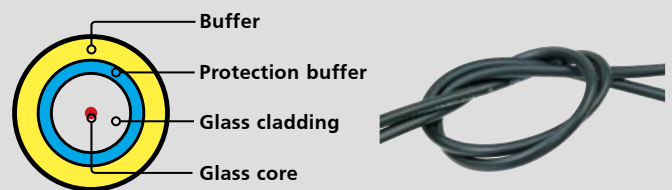

# Technical Data

Technical Data Optical Cable Connector		
Optical connector	LC-Duplex	
Fiber	Multimode, Singlemode PC / APC	●
Insertion loss	< 0.45 dB / connection	●
min. Return loss	MM PC > 25 dB	●
	SM PC > 50 dB	●
	SM APC > 60 dB	●
MECHANICAL		
Insertion / withdrawal force	< 45 N	●
Lifetime (mating cycles)	> 2'500	●
Cable retention force	Fiber only > 500 N	●
	Hybrid > 500 N	●
	SMPTE > 500 N	●
MATERIAL		
Shell	PBT 30% GR	●
Insert / Insulation	PBT 30% GR	●
Strain relief	Brass, Ni plated	●
Bushing	PA6	●
Boot	EPDM, rubber boot	●
Split sleeve	Ceramics	●
ENVIRONMENTAL		
Operating temp.	-40°C to +75°C	●
Flammability	UL94 HB	●
Protection class	in mated condition IP65	●

Technical Data Cables	2M	25(A)
Max. number of fibers	2	2
Mode - Multimode PC	●	-
- Single mode PC / APC	-	●
Fiber - 50 / 125-OM3	●	-
- 9 / 125-G657A2	-	●
Bend optimized fiber	●	●
Laser optimized fiber	●	-
Cable retention		
- Aramid yarn	●	●
- Crimp type	-	-
Overall diameter (mm)	3.0	3.0
Jacket - PUR black matte	●	●
Optical connector		
- LC-Duplex	-	-
- LC based	●	●
Min. bending radius (cm)	3.0	3.0
Weight (kg / km)	9	9
Attenuation (dB / km)	@ 850 nm ≤ 3.0 @ 1300 nm ≤ 1.0	@ 1310 nm ≤ 0.35 @ 1550 nm ≤ 0.21
Bandwidth (MHz-km)	@ 850 nm ≥ 1500 @ 1300 nm ≥ 500	@ 850 nm ≥ 1500 @ 1300 nm ≥ 500
Refraction index	@ 850 nm - 1.481 @ 1300 nm - 1.476	@ 1310 nm - 1.467 @ 1550 nm - 1.468

## Accessories for Cable Connector



SCNKO-L



NOR-\*

SCNKO-L	Rubber dirt protection for opticalCON LITE cable connector (spare part)
NOR-*	Color coding ring for cable connector chassis
*: 0- black, 1- brown, 2- red, 3- orange, 4- yellow, 5- green, 6- blue, 7- violet, 8- grey, 9- white	

## Packaging options and max. cable length see on the part number generator - [www.neutrik.com](http://www.neutrik.com)

**0**

-0... Only airspool packaging available

# opticalCON® QUAD LITE

## Cable Connector Assembly



NKO4M-L\*

- 4-channel fiber optic connection system
- Waterproof acc. to IP65 safety standard in mated condition
- Push-pull locking mechanism
- Recommended for point-to-point connection
- Easy to clean, no special tools required
- Tactical patch cable
- Compatible with standard opticalCON ADVANCED NO4FDW-A chassis

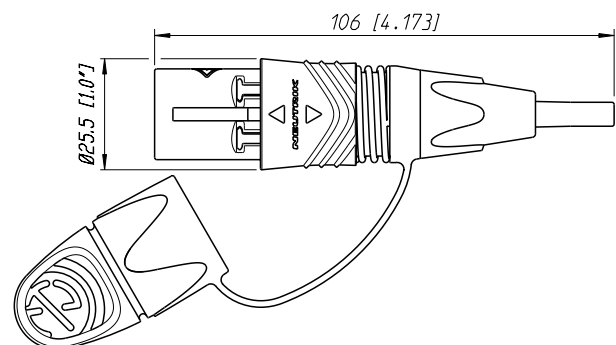
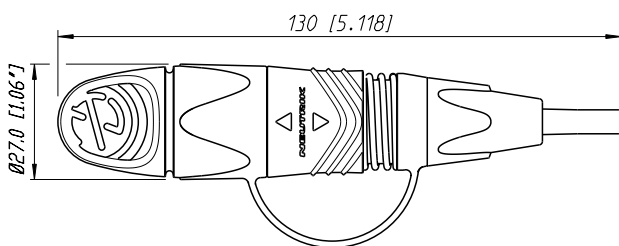

# Technical Data

Technical Data Optical Cable Connector		
Optical connector		PC
Fiber	Multimode, Singlemode PC / APC	●
Insertion loss	< 0.45 dB / connection	●
min. Return loss	MM PC > 25 dB	●
	SM PC > 50 dB	●
	SM APC > 60 dB	●
MECHANICAL		
Insertion / withdrawal force	< 45 N	●
Lifetime (mating cycles)	> 2'500	●
Cable retention force	Fiber only > 500 N	●
	Hybrid > 500 N	●
	SMPTE > 500 N	●
MATERIAL		
Shell	PBT 30% GR	●
Insert / Insulation	PBT 30% GR	●
Strain relief	Brass, Ni plated	●
Bushing	PA6	●
Boot	EPDM, rubber boot	●
Split sleeve	Ceramics	●
ENVIRONMENTAL		
Operating temp.	-40°C to +75°C	●
Flammability	UL94 HB	●
Protection class	in mated condition IP65	●

Technical Data Cables		
	4M	4S(A)
Max. number of fibers	4	4
Mode - Multimode PC	●	-
- Single mode PC / APC	-	●
Fiber - 50 / 125-OM3	●	-
- 9 / 125-G657A2	-	●
Bend optimized fiber	●	●
Laser optimized fiber	●	-
Cable retention		
- Aramid yarn	●	●
- Crimp type	-	-
Overall diameter (mm)	3.5	3.5
Jacket - PUR black matte	●	●
Optical connector		
- LC-Duplex	-	-
- LC based	●	●
Min. bending radius (cm)	3.5	3.5
Weight (kg / km)	14	12
Attenuation (dB / km)	@ 850 nm ≤ 3.0 @ 1300 nm ≤ 1.0	@ 1310 nm ≤ 3.0 @ 1550 nm ≤ 1.0
Bandwidth (MHz-km)	@ 850 nm ≥ 1500 @ 1300 nm ≥ 500	@ 850 nm ≥ 1500 @ 1300 nm ≥ 500
Refraction index	@ 850 nm - 1.481 @ 1300 nm - 1.476	@ 850 nm - 1.481 @ 1300 nm - 1.476

## Accessories for Cable Connector



SCNKO-L



NOR-\*

SCNKO-L	Rubber dirt protection for opticalCON LITE cable connector (spare part)										
NOR-*	Color coding ring for cable connector chassis										
*: 0- black, 1- brown, 2- red, 3- orange, 4- yellow, 5- green, 6- blue, 7- violet, 8- grey, 9- white											
	<table border="1"> <tr> <td>0</td><td>1</td><td>2</td><td>3</td><td>4</td><td>5</td><td>6</td><td>7</td><td>8</td><td>9</td> </tr> </table>	0	1	2	3	4	5	6	7	8	9
0	1	2	3	4	5	6	7	8	9		

## Packaging options and max. cable length see on the part number generator - [www.neutrik.com](http://www.neutrik.com)

0



-0... Only airspool packaging available



# opticalCON® MTP® 12 LITE Cable Connector Assembly



NKO12SA-L\*

- 12-channel MTP® based fiber optic connection system
- Waterproof acc. to IP65 safety standard in mated condition
- Recommended for multi-signal transmission
- Push-pull locking mechanism
- Custom color coding
- Rugged housing
- Rubber protection cap
- Compatible with standard opticalCON ADVANCED NO12FDW-A chassis

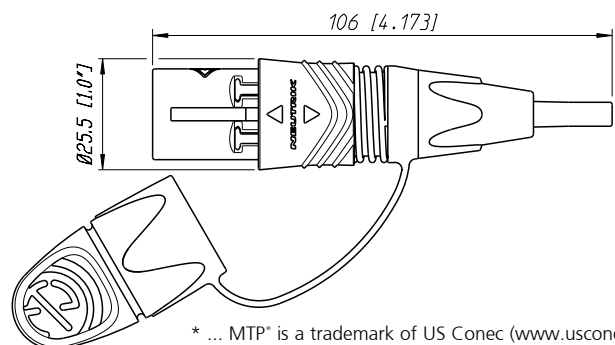
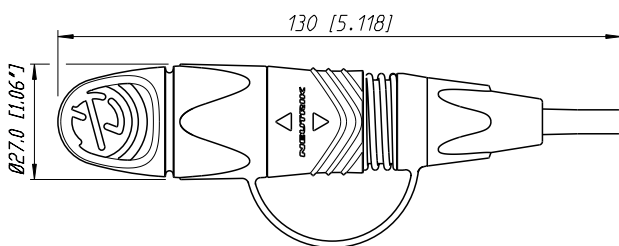

\* ... MTP® is a trademark of US Conec ([www.usconec.com](http://www.usconec.com))



# Technical Data

## Technical Data Optical Cable Connector

Optical connector	MTP® ELITE	
	female	
Fiber	Multimode, Singlemode APC	●
Insertion loss	< 0.9 dB / connection	●
min. Return loss	MM PC > 25 dB	●
	SM APC > 60 dB	●

### MECHANICAL

Insertion / withdrawal force	< 45 N	●
Lifetime (mating cycles)	> 1'500	●
Cable retention force	Fiber only > 500 N	●
	Hybrid > 500 N	●
	SMPTE > 500 N	●

### MATERIAL

Shell	PBT 30% GR	●
Insert / Insulation	PC, PEI	●
Strain relief	Brass, Ni plated	●
Bushing	PA6	●
Boot	EPDM, rubber boot	●

### ENVIRONMENTAL

Operating temp.	-40°C to +75°C	●
Flammability	UL94 HB	●
Protection class	in mated condition IP65	●

## Technical Data Cables

	12M	12SA
Max. number of fibers	12	12
Mode - Multimode PC	●	-
- Single mode PC / APC	-	●
Fiber - 50 / 125-OM3	●	-
- 9 / 125-G657A2	-	●
Bend optimized fiber	●	●
Laser optimized fiber	●	-
Cable retention		
- Aramid yarn	●	●
- Crimp type	-	-
Overall diameter (mm)	3.5	3.5
Jacket - PUR black matte	●	●
Optical connector		
- LC-Duplex	-	-
- LC based	●	●
Min. bending radius (cm)	3.5	3.5
Weight (kg / km)	12.0	12.0
Attenuation (dB / km)	@ 850 nm ≤ 3.0 @ 1300 nm ≤ 1.0	@ 1310 nm ≤ 3.0 @ 1550 nm ≤ 1.0
Bandwidth (MHz-km)	@ 850 nm ≥ 1500 @ 1300 nm ≥ 500	@ 850 nm ≥ 1500 @ 1300 nm ≥ 500
Refraction index	@ 850 nm - 1.481 @ 1550 nm - 1.476	@ 1310 nm - 1.481 @ 1550 nm - 1.476

## Accessories for Cable Connector



SCNKO-L



NOR-\*

SCNKO-L Rubber dirt protection for opticalCON LITE cable connector (spare part)

NOR-\* Color coding ring for cable connector chassis

\*: 0- black, 1- brown, 2- red, 3- orange, 4- yellow, 5- green, 6- blue, 7- violet, 8- grey, 9- white



Packaging options and max. cable length see on the part number generator - [www.neutrik.com](http://www.neutrik.com)

0



-0... Only airspool packaging available



# opticalCON® MTP® 24 LITE Cable Connector Assembly



NKO24M-L\*

- 24-channel MTP® based fiber optic connection system
- Waterproof acc. to IP65 safety standard in mated condition
- Recommended for multi-signal transmission
- Push-pull locking mechanism
- Custom color coding
- Rugged housing
- Rubber protection cap
- Compatible with standard opticalCON ADVANCED NO24FDW-A chassis

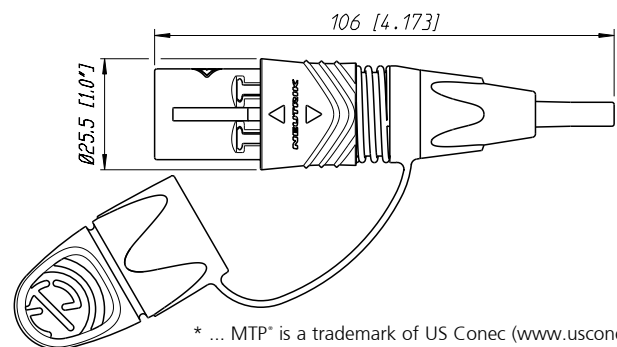
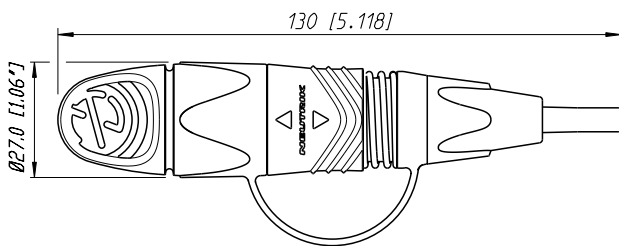

\* ... MTP® is a trademark of US Conec ([www.usconec.com](http://www.usconec.com))

# Technical Data

Technical Data Optical Cable Connector		
Optical connector		MTP® ELITE female
Fiber	Multimode, Singlemode APC	●
Insertion loss	< 0.9 dB / connection	●
min. Return loss	MM PC > 25 dB	●
	SM APC > 60 dB	●
MECHANICAL		
Insertion / withdrawal force	< 45 N	●
Lifetime (mating cycles)	> 1'500	●
Cable retention force	Fiber only > 500 N	●
	Hybrid > 500 N	●
	SMPTE > 500 N	●
MATERIAL		
Shell	PBT 30% GR	●
Insert / Insulation	PC, PEI	●
Strain relief	Brass, Ni plated	●
Bushing	PA6	●
Boot	EPDM, rubber boot	●
ENVIRONMENTAL		
Operating temp.	-40°C to +75°C	●
Flammability	UL94 HB	●
Protection class	in mated condition IP65	●

Technical Data Cables		
	24M	24SA
Max. numbers of fibers	24	24
Mode	- Multimode PC	-
	- Single mode PC / APC	●
Fiber	- 50 / 125-OM3	-
	- 9 / 125-G657A2	●
Bend optimized fiber	●	●
Laser optimized fiber	●	-
Cable retention		
	- Aramid yarn	●
	- Crimp type	-
Overall diameter (mm)	3.5	3.5
Jacket	- PUR black matte	●
Optical connector		
	- LC-Duplex	-
	- LC based	●
Min. bending radius (cm)	3.5	3.5
Weight (kg / km)	12.0	12.0
Attenuation (dB / km)	@ 850 nm ≤ 3.0 @ 1300 nm ≤ 1.0	@ 1310 nm ≤ 3.0 @ 1550 nm ≤ 1.0
Bandwidth (MHz-km)	@ 850 nm ≥ 1500 @ 1300 nm ≥ 500	@ 850 nm ≥ 1500 @ 1300 nm ≥ 500
Refraction index	@ 850 nm - 1.481 @ 1550 nm - 1.476	@ 1310 nm - 1.481 @ 1550 nm - 1.476

## Accessories for Cable Connector



SCNKO-L



NOR-\*

SCNKO-L	Rubber dirt protection for opticalCON LITE cable connector (spare part)										
NOR-*	Color coding ring for cable connector chassis										
	*: 0- black, 1- brown, 2- red, 3- orange, 4- yellow, 5- green, 6- blue, 7- violet, 8- grey, 9- white										
	<table border="1"> <tr> <td>0</td><td>1</td><td>2</td><td>3</td><td>4</td><td>5</td><td>6</td><td>7</td><td>8</td><td>9</td> </tr> </table>	0	1	2	3	4	5	6	7	8	9
0	1	2	3	4	5	6	7	8	9		

## Packaging options and max. cable length see on the part number generator - [www.neutrik.com](http://www.neutrik.com)

0



-0... Only airspool packaging available



# opticalCON<sup>®</sup> CHASSIS CONNECTORS



# Features & Benefits

- Small form factor
- Automatic sealing shutter
- Simple integration



opticalCON DUO	opticalCON QUAD	opticalCON MTP® 12	opticalCON MTP® 24
 <p data-bbox="312 1436 432 1457">NO2-4FDW-A</p>  <p data-bbox="121 1673 336 1694">Standard LC connector</p>	 <p data-bbox="676 1436 796 1457">NO4FDW-A</p>  <p data-bbox="472 1673 687 1694">Standard LC connector</p>	 <p data-bbox="1008 1436 1128 1457">NO12FDW-A</p>  <p data-bbox="820 1673 1094 1694">MTP® ELITE MALE connector</p>	 <p data-bbox="1355 1436 1474 1457">NO24FDW-A</p>  <p data-bbox="1166 1673 1441 1694">MTP® ELITE MALE connector</p>
			

# opticalCON® DUO ADVANCED

## Chassis Connector



NO2-4FDW-A with SCDP-0

- Ruggedized and dirt-protected 2-channel fiber optic connection system
- Shutter with silicon gasket protects optical connection from dust and dirt
- Suggested OEM equipment connectors due to LC front compatibility
- Accommodates standard LC connectors on the rear for simple installation
- IP65 ingress protection in mated condition with SCDP-\*
- Connection on the front side either by rugged opticalCON or standard LC connector

Example: opticalCON DUO Chassis with transceiver adapter and SFP transceiver



NAO2\*-SFP-LC

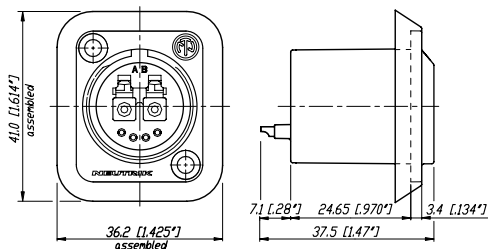

# Technical Data

## Technical Data Optical Chassis Connector

Optical connector		LC-Duplex Feedthrough
Fiber	Multimode, Singlemode PC / APC	●
Insertion loss	< 0.45 dB / connection	●
min. Return loss	MM PC > 25 dB	●
	SM PC > 50 dB	●
	SM APC > 60 dB	●

## MECHANICAL

Insertion / withdrawal force	< 45 N	●
Lifetime (mating cycles)	> 5'000	●

## ELECTRICAL

Number of electrical contacts	4 (5) <sup>2</sup>	●
Rated current	6 A	●
	10 A (contact 1+4)	●
Contact resistance	< 7 mΩ	●
Insulation resistance	- initial: > 10 GΩ	●
	- after damp heat test: > 1 GΩ	●
Dielectric strength	1500 V dc	●
Rated voltage	50 V ac	● <sup>1</sup>

## MATERIAL

Shell	Zinc diecast (ZnAl4Cu1), black chrome plating	●
Insert / Insulation	Polyamid PA 6, PBT 30% GR	●
Insert colour	MM: black, SM PC: blue; SM APC: green	●
Contacts	female: Brass (CuZn39Pb3)	●
Contact surface	Gold (gal 0.2 μm Au over 2 μm Ni)	●
Split sleeve	Ceramics	●

## ENVIRONMENTAL

Operating temp.	-40°C to +75°C	●
Flamability	UL94 HB	●
Solderability	complies with IEC 68-2-20	●
Protection class	in combination with SCDP-* in mated condition IP65	●

<sup>1</sup> ... Not compatible to SMPTE 304M standard. Suitable for indoor (studio) camera links considering specific conditions acc. to IEC 60664-1 like pollution degree 1, overvoltage category 1 and rated voltage. For detailed information ask for the White Paper "opticalCON @ SMPTE Indoor Applications".

<sup>2</sup> ... Shell ground contacts

## opticalCON DUO Chassis

	Type	Plating	Fiber	Solder contacts	Shell ground contact	Wiring
NO2-4FDW-A	Chassis	Black Chrome	2	4	-	-
NO2-4FDW-1-A	Chassis	Black Chrome	2	4	1	-

# opticalCON® QUAD ADVANCED

## Chassis Connector



NO4FDW-A with SCDP-0

- Ruggedized and dirt-protected 4-channel fiber optic connection system
- For point-to-point multichannel routing
- Laser protective metal shutter seals dust proof with two-component rubber gasket
- IP65 ingress protection in mated condition with SCDP-\*
- Accommodates standard LC connectors on the rear for simple installation

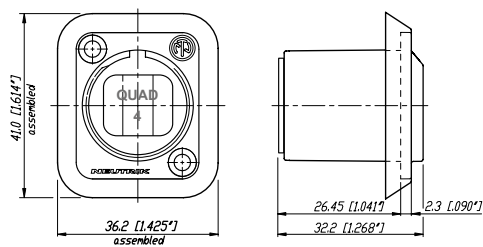



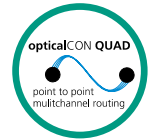

# Technical Data

## Technical Data Optical Chassis Connector

Optical connector		PC
		Feedthrough
Fiber	Multimode, Singlemode PC / APC	●
Insertion loss	< 0.45 dB / connection	●
min. Return loss	MM PC > 25 dB	●
	SM PC > 50 dB	●
	SM APC > 60 dB	●

## MECHANICAL

Insertion / withdrawal force	< 45 N	●
Lifetime (mating cycles)	> 5'000	●

## MATERIAL

Shell	Zinc diecast (ZnAl4Cu1), black chrome plating	●
Insert / Insulation	Polyamid PA 6, PBT 30% GR	●
Insert colour	MM: black, SM PC: blue; SM APC: green	●
Split sleeve	Ceramics	●

## ENVIRONMENTAL

Operating temp.	-40°C to +75°C	●
Flamability	UL94 HB	●
Protection class	in combination with SCDP-* in mated condition IP65	●

## opticalCON QUAD Chassis

	Type	Plating	Fiber	Solder contacts	Shell ground contact	Wiring
NO4FDW-A	Chassis	Black Chrome	4	-	-	-



# opticalCON® MTP® 12 ADVANCED Chassis Connector



NO12FDW-A with SCDP-0

- Ruggedized and dirt-protected 12-channel fiber optic connection system
- For point-to-point multichannel routing
- Laser protective metal shutter seals dust proof with two-component rubber gasket
- IP65 ingress protection in mated condition with SCDP-\*
- Accommodates standard MTP® ELITE MALE connectors on the rear for simple installation\*

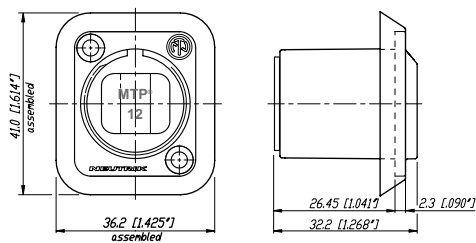

\* ... MTP® is a trademark of US Conec ([www.usconec.com](http://www.usconec.com))

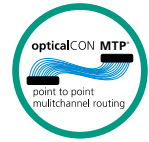

# Technical Data

## Technical Data Optical Chassis Connector

Optical connector		MTP® ELITE female
		Feedthrough
Fiber	Multimode, Singlemode APC	•
Insertion loss	< 0.9 dB / connection	•
min. Return loss	MM PC > 25 dB	•
	SM APC > 60 dB	•

## MECHANICAL

Insertion / withdrawal force	< 45 N	•
Lifetime (mating cycles)	> 2'500	•

## MATERIAL

Shell	Zinc diecast (ZnAl4Cu1), black chrome plating	•
Insert / Insulation	Polyamid PA 6, PBT 30% GR	•
Insert colour	MM: black, SM PC: blue; SM APC: green	•

## ENVIRONMENTAL

Operating temp.	-40°C to +75°C	•
Flamability	UL94 HB	•
Protection class	in combination with SCDP-* in mated condition IP65	•

## opticalCON MTP®12 Chassis

	Type	Plating	Fiber	Solder contacts	Shell ground contact	Wiring
NO12FDW-A	Chassis	Black Chrome	12	-	-	-



# opticalCON® MTP® 24 ADVANCED Chassis Connector



NO24FDW-A with SCDP-0

- Ruggedized and dirt-protected 24-channel fiber optic connection system
- For point-to-point multichannel routing
- Laser protective metal shutter seals dust proof with two-component rubber gasket
- IP65 ingress protection in mated condition with SCDP-\*
- Accommodates standard MTP® ELITE MALE connectors on the rear for simple installation\*

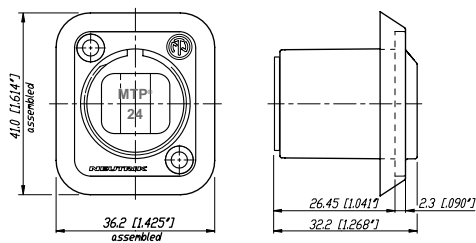

\* ... MTP® is a trademark of US Conec ([www.usconec.com](http://www.usconec.com))

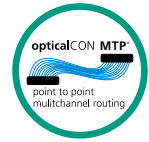

# Technical Data

## Technical Data Optical Chassis Connector

Optical connector		MTP® ELITE female
		Feedthrough
Fiber	Multimode, Singlemode APC	•
Insertion loss	< 0.9 dB / connection	•
min. Return loss	MM PC > 25 dB	•
	SM APC > 60 dB	•

## MECHANICAL

Insertion / withdrawal force	< 45 N	•
Lifetime (mating cycles)	> 2'500	•

## MATERIAL

Shell	Zinc diecast (ZnAl4Cu1), black chrome plating	•
Insert / Insulation	Polyamid PA 6, PBT 30% GR	•
Insert colour	MM: black, SM PC: blue; SM APC: green	•

## ENVIRONMENTAL

Operating temp.	-40°C to +75°C	•
Flamability	UL94 HB	•
Protection class	in combination with SCDP-* in mated condition IP65	•

## opticalCON MTP®24 Chassis

	Type	Plating	Fiber	Solder contacts	Shell ground contact	Wiring
NO24FDW-A	Chassis	Black Chrome	24	-	-	-



# Ordering Information

## Accessories for Chassis & Couplers



### Accessories for Chassis



SCNO-FDW-A



SCD-NC



SCDP-\*



SCCD-W

SCNO-FDW-A	Rugged sealing cover for opticalCON chassis connectors
SCD-NC	Rubber sealing cover for opticalCON chassis connectors
SCDP-*	D-Size sealing gaskets for chassis, color coding according to ANSI/TIA-568-3-D Standard
SCCD-W	Spring-loaded cover to seals D-size chassis connectors, IP65 rated

\*: 0- black, 1- brown, 2- red, 3- orange, 4- yellow, 5- green, 6- blue, 7- violet, 8- grey, 9- white



<sup>1)</sup>: find part numbers on [www.neutrik.com](http://www.neutrik.com)

### COUPLER

Weatherproof opticalCON coupler (adapter) for cable extensions.



NAO2S-H1W-A



NAO4MW-A



NAO12SAW-A



NAO24MW-A

	Type	Colour	Plating	Fiber	Solder contacts	Shell ground contact	Wiring
NAO2M-H1W-A	Coupler	black	black	2 x LC-Duplex Multimode PC	4 x 0.75 mm <sup>2</sup>	●	ISO/IEC 11801
NAO2S-H1W-A	Coupler	blue	black	2 x LC-Duplex Singlemode PC	4 x 0.75 mm <sup>2</sup>	●	ISO/IEC 11801
NAO2SA-H1W-A	Coupler	green	black	2 x LC-Duplex Singlemode APC	4 x 0.75 mm <sup>2</sup>	●	ISO/IEC 11801
NAO2SA-H1W-AX	Coupler	green	black	2 x LC-Duplex Singlemode APC	4 x 0.75 mm <sup>2</sup>	●	crossed
NAO4MW-A	Coupler	black	black	4 x Multimode PC	-	-	ISO/IEC 11801
NAO4MW-AX	Coupler	black	black	4 x Multimode PC	-	-	crossed
NAO4SW-A	Coupler	blue	black	4 x Singlemode PC	-	-	ISO/IEC 11801
NAO4SW-AX	Coupler	blue	black	4 x Singlemode PC	-	-	crossed
NAO4SAW-A	Coupler	green	black	4 x Singlemode APC	-	-	ISO/IEC 11801
NAO4SAW-AX	Coupler	green	black	4 x Singlemode APC	-	-	crossed
NAO4SW-A-X	Coupler	red	black	4 x Singlemode PC	-	-	ISO/IEC 11801
NAO12MW-A	Coupler	black	black	12 x Multimode PC	-	-	Type A
NAO12SAW-A	Coupler	green	black	12 x Singlemode APC	-	-	Type A
NAO24MW-A	Coupler	black	black	24 x Multimode PC	-	-	Type A
NAO24SAW-A	Coupler	green	black	24 x Singlemode APC	-	-	Type A





# Transceiver Adapter

## TRANSCEIVER ADAPTER

The opticalCON Transceiver Adapter connects an opticalCON chassis (NO2-4FDW\*) and a LC SFP transceiver. NAO2\*-SFP-LC consists of two LC-SFP adapters, 2 flat gaskets (1 mm and 2 mm) and one NO2-4FDW-A without copper contacts.



MM Transceiver Adapter  
grey



SM Tranceiver Adapter  
blue



SM APC Tranceiver Adapter  
green

- Eases design integration of the opticalCON chassis connectors (NO2-4FDW\*) in combination with SFP transceivers
- Compatible with all LC SFP transceivers
- Automatic sealing shutter of the opticalCON avoids transceiver soiling
- Enables use of rugged opticalCON or conventional LC connectors
- Avoids vandalism, opticalCON "protects" the transceiver

NAO2M-SFP-LC	grey	MM Transceiver Adapter + opticalCON chassis (NO2-4FDW-A) without copper contacts
NAO2S-SFP-LC	blue	SM Transceiver Adapter + opticalCON chassis (NO2-4FDW-A) without copper contacts
NAO2SA-SFP-LC	green	SM APC Transceiver Adapter + opticalCON chassis (NO2-4FDW-A) without copper contacts

## NAOBO - Breakout ADAPTER

NAOBO is a flexible chassis mounting and adaption solution with cable strain relief to meet any kind of standard fiber connector (e.g. LC, SC, ST). It can be fixed to a rack with a cable tie. The breakout adapter can be mounted straight or angled.



NAOBO (KIT)



Application example



- Flexible chassis mounting solution
- Adaption solution to meet existing non-opticalCON fiber installation
- NAOBO can be equipped with any D-size chassis connector

NAOBO	Breakout Adapter Kit consisting of: 1 NAOBO plastic housing, 1 counter nut, 1 90° rear shell, 1 PG-gland, 1 cable tie and 2 screws
-------	---



# Breakout Solutions

## Breakout Box



NO12SABB6D-A



NO4SBB4D-PM-A  
(with powerMONITOR)



### opticalCON Breakout Box

- Breakout boxes are used to split multichannel connections as the opticalCON QUAD and MTP® to either dual or single channels
- Dust and waterproof according to IP67 in mated condition

### opticalCON Breakout Box with powerMONITOR

The breakout boxes are used to split a 4-channel point-to-point opticalCON QUAD connection. In mated condition the boxes are dust and water resistant according protection class IP54. The breakout boxes equipped with the opticalCON powerMONITOR offer attenuation measuring for all 4 channels.

The opticalCON powerMONITOR is a cost-saving, purpose-built measurement (monitoring) device for professional fiber optic broadcast, audio and video applications.

With simultaneous monitoring of attenuation for up to 4 transmission channels, powerMONITOR provides an immediate, "on air" view into fiber optic signal strength. Visual and audible alarms can be set individually for each fiber channel, based on each channel's power budget. powerMONITOR provides clear status information, delivers early warnings for potential problems, and assists with maintenance scheduling.

- On-air monitoring of fiber optic transmission quality
- Simultaneous power measurement (+0.0/-0.1 dB measurement accuracy) of up to 4 channels
- Programmable-threshold alarms
- Rackmount and mobile units
- Operates on rechargeable battery power or on mains power with fail-safe battery backup in case of unexpected mains power interruption
- Low loss (0.5 dB maximum split loss)
- Wavelength selectable: multimode 850 nm or 1300 nm, single mode 1310 nm, 1550 nm or WDM (wave division multiplexing)





### Breakout Box

NO4SBB2D-A <sup>1)</sup>	1 x NO4FDW-A to 2 x NO2-4FDW-A, Singlemode PC
NO4SABB2D-A <sup>1)</sup>	1 x NO4FDW-A to 2 x NO2-4FDW-A, Singlemode APC
NO4MBB2D-A <sup>1)</sup>	1 x NO4FDW-A to 2 x NO2-4FDW-A, Multimode PC
NO4SBB4D-A	1 x NO4FDW-A to 4 x NO2-4FDW-A, Singlemode PC
NO4SABB4D-A	1 x NO4FDW-A to 4 x NO2-4FDW-A, Singlemode APC
NO4MBB4D-A	1 x NO4FDW-A to 4 x NO2-4FDW-A, Multimode PC
NO12SAABB6D-A	1 x NO12FDW-A to 6 x NO2-4FDW-A, Singlemode APC to APC
NO12SABB6D-A	1 x NO12FDW-A to 6 x NO2-4FDW-A, Singlemode APC to PC
NO12MBB6D-A	1 x NO12FDW-A to 6 x NO2-4FDW-A, Multimode PC
NO12SAABB3Q-A	1 x NO12FDW-A to 3 x NO4FDW-A, Singlemode APC to APC
NO12SABB3Q-A	1 x NO12FDW-A to 3 x NO4FDW-A, Singlemode APC to PC
NO12MBB3Q-A	1 x NO12FDW-A to 3 x NO4FDW-A, Multimode PC
NO24SABB2M12-A	1 x NO24FDW-A to 2 x NO12FDW-A, Singlemode APC
NO24MBB2M12-A	1 x NO24FDW-A to 2 x NO12FDW-A, Multimode PC

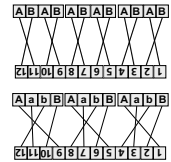
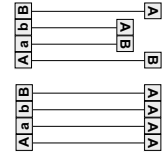

### Breakout Box with powerMONITOR

NO*BB1*-PM-A <sup>1)</sup>	breakout box equipped with opticalCON powerMONITOR <sup>1)</sup> ... add attribute X for crossed fiber wiring
----------------------------	--



### Power Supply for powerMONITOR



NOPS-1RU-PM



NOPS-3RU-PM



NOPS-E-PM

NOPS-1RU-PM	opticalCON powerMONITOR 5W Power Supply, powers up to 2 power monitors, Intern. AC plugs included
NOPS-3RU-PM	opticalCON powerMONITOR 15W Power Supply, 1 + 3RU use, powers up to 9 power monitors, IEC power socket
NOPS-E-PM	opticalCON powerMONITOR, power supply extension cable to daisy-chain power

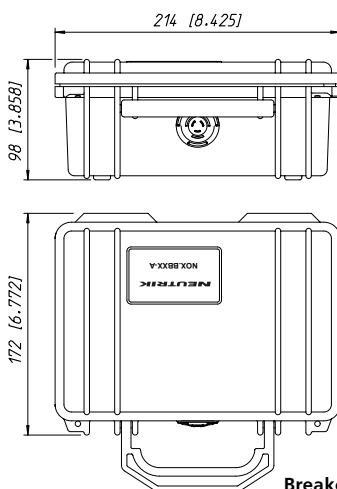

Breakout Box

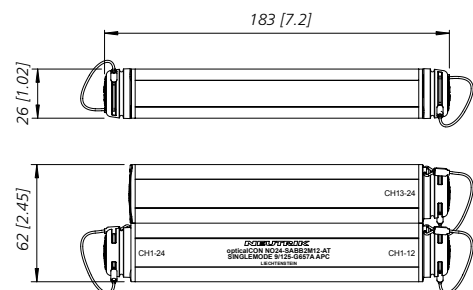

NO24SABB2M12-A

# opticalCON® powerMONITOR®

## On air monitoring of fiber optic transmission quality

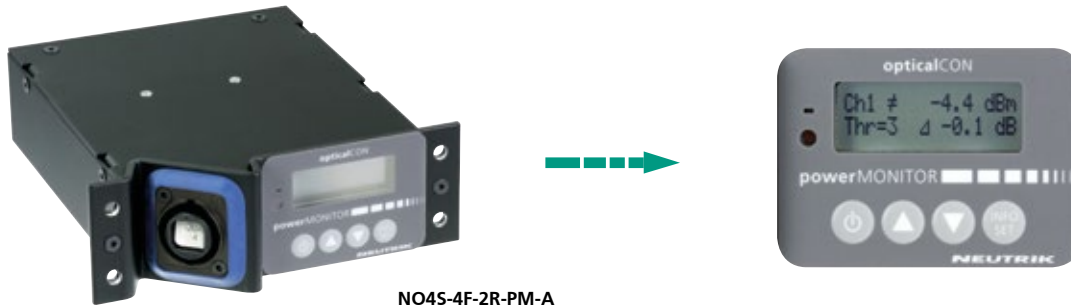

NO4S-4F-2R-PM-A

The opticalCON powerMONITOR is a cost-saving, purpose-built measurement (monitoring) device for professional fiber optic broadcast, audio and video applications. With simultaneous monitoring of attenuation for up to 4 transmission channels, powerMONITOR provides an immedi-

ate, "on air" view into fiber optic signal strength. Visual and audible alarms can be set individually for each fiber channel, based on each channel's power budget. powerMONITOR provides clear status information, delivers early warnings for potential problems, and assists with maintenance scheduling.

- On-air monitoring of fiber optic transmission quality
- Simultaneous power measurement (+0.0/-0.1 dB measurement accuracy) of up to 4 channels
- Programmable threshold alarms
- Rack mount and mobile units
- Operates on rechargeable battery power or on mains power with fail-safe battery backup in case of unexpected mains power interruption
- Low loss (0.5 dB maximum split loss)
- Wavelength selectable: multimode 850 nm or 1300 nm, single mode 1310 nm, 1550 nm or WDM (wave division multiplexing)

### Example



Front view: e.g. 4F (opticalCON QUAD)



Rear view: e.g. 2R (opticalCON DUO)

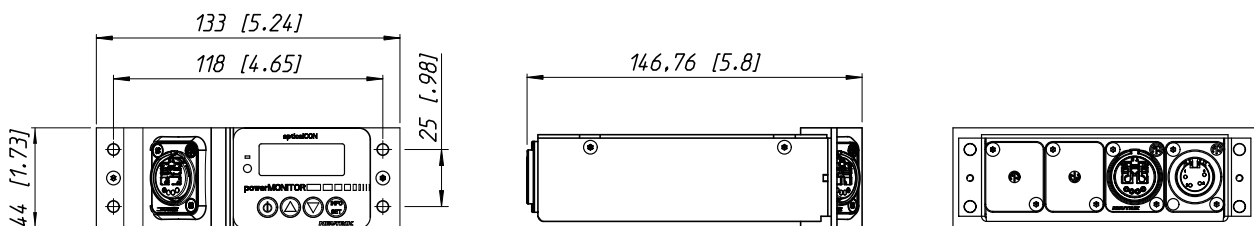



## powerMONITOR

	Channel	Mode	Chassis Front	Chassis Rear
NO2S-2F-2R-PM-A	2	S	DUO	DUO
NO2SA-2F-2R-PM-A	2	SA	DUO	DUO
NO4SA-2F-2R-PM-A	4	SA	QUAD	DUO
NO4SA-4F-4R-PM-A	4	SA	QUAD	QUAD
NO4M-4F-4R-PM-A	4	M	QUAD	QUAD

<sup>1)</sup> ... add attribute X for crossed fiber wiring



## Power Supply for powerMONITOR



NOPS-1RU-PM



NOPS-3RU-PM



NOPS-E-PM

NOPS-1RU-PM

opticalCON powerMONITOR 5W Power Supply, powers up to 2 power monitors, Intern. AC plugs included

NOPS-3RU-PM

opticalCON powerMONITOR 15W Power Supply, 1 + 3RU use, powers up to 9 power monitors, IEC power socket

NOPS-E-PM

opticalCON powerMONITOR, power supply extension cable to daisy-chain power

## 1 RU & 3 RU 19" Rack units with powerMONITOR



NO4S-4F-2R-PM-A (up to two powerMONITOR's)



up to 9 powerMONITOR's

# Panel Solutions

## 19" D-Shape Z-Panels & Plates



NZPF1RU



NZPF3RU

- Space saving design, ideal for cramped rack applications such as OB truck I/O panels
- Frame plate can be loaded with opticalCON DUO or QUAD and E2000 or ST or SC
- Frames can be equipped with frame plates (D-shape) or blind plates
- Best cable bend protection
- 1 RU or 3 RU frame

### Application Example:

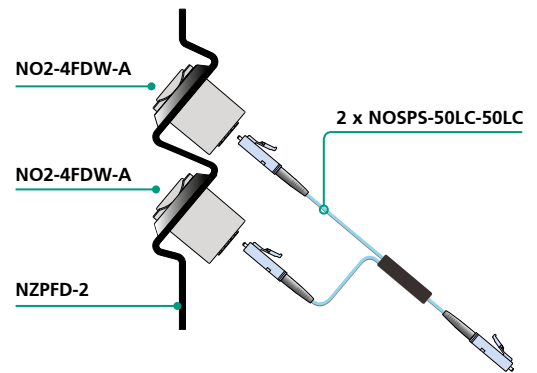

### Panel frame 1RU

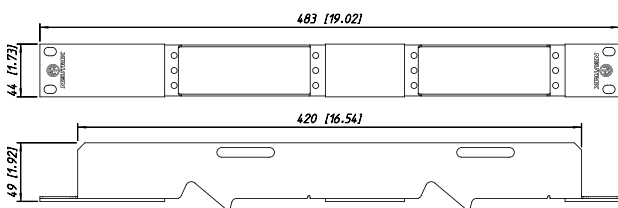

### Panel frame 3RU

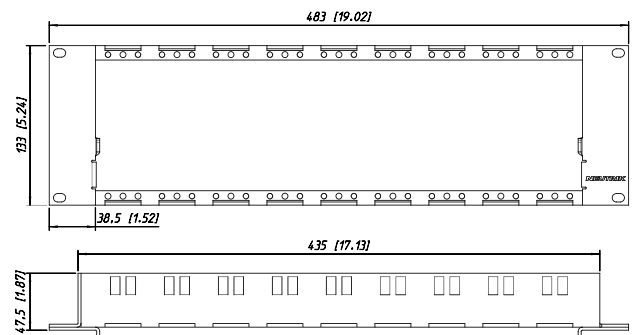



## Z-Panels

### Panel frame 1RU: NZPF1RU

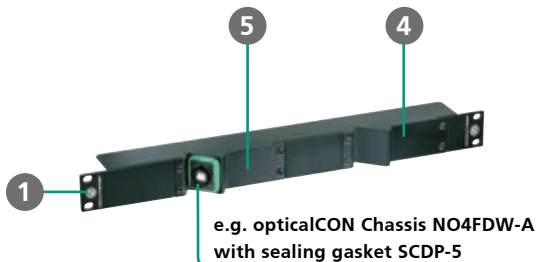

### Panel frame 3RU: NZPF3RU

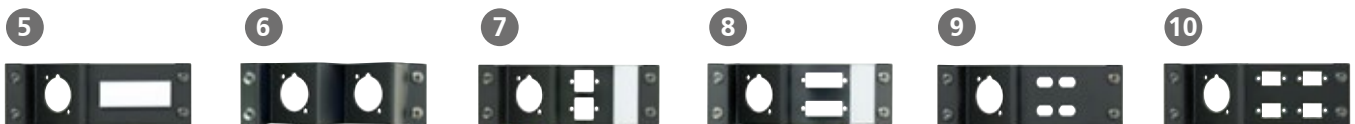
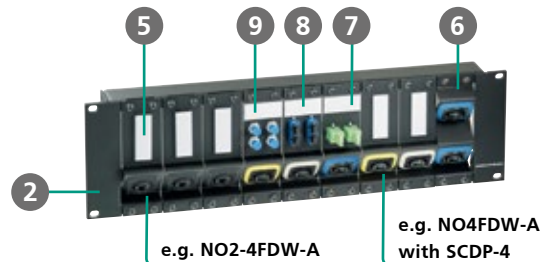

### Angled rack panel: NZP1RU-8



### Splitter: NOSPS-50LC-50LC



### Panel Frame

1	NZPF1RU	Panel frame 1RU for opticalCON panel frames
2	NZPF3RU	Panel frame 3RU for opticalCON panel frames
3	NZP1RU-8	Panel 1RU, 30° forward-turned and offers 8 x D-shape cutouts with M3 threaded fastening holes
3	NZP1RU-12	Panel 1RU, 30° forward-turned and offers 12 x D-shape cutouts with M3 threaded fastening holes

### Panel Plate

4	NZPFBP	Panel frame blind plate
5	NZPFD	Panel frame plate for opticalCON chassis connector
6	NZPFD-2	Panel frame plate 2 x D-shape cutouts (works only on NZPF3RU Panel)
7	NZPFD-4E	Panel frame plate 1 x D-shape cutout, 2 E2000 compact chassis cutouts
8	NZPFD-4SC	Panel frame plate 1 x D-shape cutout, 2 SC compact chassis cutouts
9	NZPFD-4ST	Panel frame plate 1 x D-shape cutout, 4 ST chassis cutouts
10	NZPFD-4SC-S	Panel frame plate 1 x D-shape cutout, 4 SC simplex cutouts

### Splitter

11	NOSPM-LC50-LC50	Multimode 1 x 2 splitter LC*
11	NOSPS-LC50-LC50	Singlemode PC 1 x 2 splitter LC*

\* ... other connectors (SC, ST, E200) on request

# Ordering Information

## Fiber Optic Measurement & Cleaning Kit



CAS-FOCD-ADV



FOCD-CF



FOMD-FM-MM

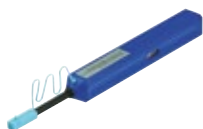

FOCD-DC125/250



FOCD-DCM



CAS-FOMD



FOMD-TC-SM1550



FOMD-FM-SM

CAS-FOCD-ADV Fiber Optic Cleaning Devices - CASE contains hand microscope, opticalCON measurement adapter, cleaning set

FOCD-CF <sup>1)</sup>	Cleaning Fluid
FOCD-DC125 <sup>1)</sup>	DRY Cleaner 1.25 mm
FOCD-DC250 <sup>1)</sup>	DRY Cleaner 2.5 mm
FOCD-DCM	DRY Cleaner MTP®, cleaning brush for guidance holes
FOCD-DW <sup>1)</sup>	Lint-free dry wipes for fiber cleaning

CAS-FOMD-ADV Fiber Optic Measurement Devices - CASE contains power source frame, 1.25 mm adapter and multimode attenuator

FOMD-TC-MM850 <sup>2)</sup>	Transceiver 850 nm multimode
FOMD-TC-SM1310 <sup>2)</sup>	Transceiver 1310 nm singlemode
FOMD-TC-SM1550 <sup>2)</sup>	Transceiver 1550 nm singlemode
FOMD-FM-MM <sup>2)</sup>	Fiber meter multimode
FOMD-FM-SM <sup>2)</sup>	Fiber meter singlemode

<sup>1)</sup> ... refill consumable, in CAS-FOCD included

<sup>2)</sup> ... combine with CAS-FOMD



## Fiber Optic Cleaning Accessories



FOCD-STD



FOCD-STQ



FOCD-STM

- Enhanced inspection and cleaning procedure
- Lockable with opticalCON cable connector
- Compatible with conventional cleaning and inspection equipment

FOCD-STD	Service tool for opticalCON DUO
FOCD-STQ	Service tool for opticalCON QUAD
FOCD-STM	Service tool for opticalCON MTP®

## opticalCON Connector Field Assembly



opticalCON connector Field assembly

- Neutrik opticalCON field assembly kit
- Based on Corning UniCam pre-polished LC connectors
- No additional tooling required
- Requires completion of a certified Neutrik opticalCON field assembly training
- Find more details on [www.neutrik.com](http://www.neutrik.com)

**LIECHTENSTEIN (HEADQUARTERS)**

NEUTRIK AG, Im alten Riet 143,  
9494 Schaan, Liechtenstein  
T +423 237 24 24, F +423 232 53 93, neutrik@neutrik.com

**CHINA**

Ningbo Neutrik Trading Co., Ltd., Shiqi Street, Yinxian Road West  
Fengjia Villiage, Hai Shu District, Ningbo, Zhejiang, 315153  
T +86 574 88250833, sales@neutrik.com.cn

**HONG KONG**

Neutrik Hong Kong LTD., Suite 18,  
7th Floor Shatin Galleria Fotan, Shatin  
T +852 2687 6055, sales@neutrik.com.hk

**USA**

Neutrik USA Inc., 4115 Taggart Creek Road,  
Charlotte, North Carolina, 28208  
T +1 704 972 30 50, info@neutrikusa.com

**GERMANY / NETHERLANDS / DENMARK / AUSTRIA**

Neutrik Vertriebs GmbH, Felix-Wankel-Strasse 1,  
85221 Dachau, Germany  
T +49 8131 28 08 90, neutrik@neutrik.de

**JAPAN**

Neutrik Limited, Yusen-Higashinohbashi-Ekimae Bldg., 3-7-19  
Higashinohbashi, Chuo-ku, Tokyo 103  
T +81 3 3663 47 33, mail@neutrik.co.jp

**INDIA**

Neutrik India Pvt. Ltd., Level 3, Neo Vikram, New Link Road,  
Above Audi Show Room, Andheri West, Mumbai, 400053  
T +91 982 05 43 424, anklesaria@neutrik.com

**ASSOCIATED COMPANIES**

Contrik AG, Steinackerstrasse 35, 8902 Urdorf, Switzerland  
T +41 44 736 50 10, contrik@contrik.ch

H. Adam GmbH, Felix-Wankel-Straße 1, 85221 Dachau, Germany  
T +49 08131 28 08-0, anfrage@adam-gmbh.de

**FRANCE**

Neutrik France SARL, Rue du Parchamp 13,  
92100 Boulogne-Billancourt  
T +33 1 41 31 67 50, info@neutrik.fr

**GREAT BRITAIN**

Neutrik (UK) Ltd., Westridge Business Park, Cothey Way Ryde,  
Isle of Wight PO33 1 QT  
T +44 1983 811 441, sales@neutrik.co.uk

opticalCON Guide – NF05 V22 – 2019 03 - Data subject to change without prior notice. © 2019 NEUTRIK®  
NEUTRIK®, opticalCON® are registered trademarks of NEUTRIK AG. ALL RIGHTS RESERVED.

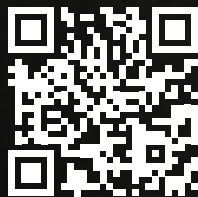

[www.neutrik.com](http://www.neutrik.com)





## X-ON Electronics

Largest Supplier of Electrical and Electronic Components

*Click to view similar products for [Fibre Optic Cable Assemblies](#) category:*

*Click to view products by [Neutrik](#) manufacturer:*

Other Similar products are found below :

[7-21002-9](#) [760-1518](#) [FA04390-50-M-72-LC-N](#) [MLB 501 V RED](#) [MLB 501 V YELLOW](#) [1-3636-600-5208](#) [2061529-7](#) [1-6693182-0](#)  
[1754898-1](#) [21055-6](#) [FXBSCSCE2LM002](#) [3000005](#) [3-21053-2](#) [MLB 200/1 V BLACK](#) [MLB 2001 V RED](#) [MLB 2001 V YELLOW](#) [MLB 501](#)  
[V BLACK](#) [5492011-6](#) [106284-7000](#) [5492011-5](#) [5492011-8](#) [5492011-9](#) [8-21007-5](#) [2123524-2](#) [2123524-1](#) [106386-4447](#) [DFSM-SCSC-2M](#)  
[2123909-4](#) [2123909-8](#) [106273-0629](#) [2125046-1](#) [2821236-3](#) [2821310-2](#) [2821310-3](#) [2821313-4](#) [FX2ERLNLNSNM0.5](#) [CF-980062-074](#) [CF-](#)  
[901200-394](#) [CF-980062-073](#) [CF-980062-071](#) [CF-980062-075](#) [CF-980062-072](#) [17-300310-100](#) [2821236-2](#) [2821313-1](#) [G-FC-FC-S-002.0-DX-](#)  
[A-18-Y](#) [G-E2A-E2A-S-003.0-SX-A-18-Y](#) [956-322-502214](#) [FA04474](#) [1083665](#)