

From Off-The-Shelf to Market-Ready© New Age Enclosures is your Single Source Solution.
Let us quote modifying our Stock Enclosures to meet your end-use.
visit newageenclosures.com/services or call 855-4NA-ENCL today.

CNC CUTOUTS
PART DECORATING
CUSTOM COLOR AND MATERIAL
RF/EMI SHIELDING
CUSTOM TOOL INSERTS
CUSTOM ENCLOSURES AND DESIGN



NEW AGE
ENCLOSURES

DEVELOP THE FUTURE



NOTES: UNLESS OTHERWISE SPECIFIED

1. CORNERS DRAWN SHARP TO BE R.005 MAXIMUM.
2. EXTERIOR SURFACE TEXTURE TO BE LIGHT EDM FINISH. EQUIVALENT TO MT-11020. TEXTURE ON ENCLOSURE WILL VARY FROM TIME TO TIME AS THE TOOL WEARS AND IT BECOMES NECESSARY TO REAPPLY.
3. INTERIOR SURFACE TEXTURE TO BE: B3
4. ALL INSIDE RADII .010R. UNLESS OTHERWISE SPECIFIED.
5. ALL EXTERNAL DIMENSIONS AFFECTED BY THE DRAFT APPLY AT THE LARGE END OF THE FEATURE, AND ALL INTERNAL FEATURES AFFECTED BY THE DRAFT APPLY AT THE SMALL END OF THE FEATURE UNLESS OTHERWISE SPECIFIED.
6. ONE DEGREE DRAFT IN THE DIRECTION OF PULL IS PERMISSIBLE UNLESS OTHERWISE SPECIFIED.
7. MATERIAL / COLOR: SEE OPTIONS TABLE FOR STANDARD MATERIAL AND COLOR OPTIONS. CUSTOM MATERIALS AND COLORS ARE AVAILABLE UPON REQUEST FOR QUOTE. ALTERNATE RESINS HAVE DIFFERENT SHRINK RATES, AND WILL EFFECT DIMENSIONS.
8. PCB SIZES ARE RECOMMENDATIONS ONLY. FINAL SIZES AND VERIFICATION OF ITS FIT ARE THE SOLE RESPONSIBILITY OF EACH CUSTOMER.
9. THIS DRAWING IS BASED ON A SOLID MODEL, AND IS FURTHER DEFINED BY THE SOLID MODEL FILE.
10. ALLOWABLE FLASH: 0.010 MAX.
11. ALL EJECTOR PIN MARKS TO BE WITHIN 0.010" OF FLUSH, PROTRUDING OR BELOW FLUSH.
13. TRIM GATE WITHIN 0.030" OF FLUSH.



SCALE 1.000

R E V I S I O N					
REV.	DRAWN BY	ECO No	DESCRIPTION	DATE	APPROVE
A	M BOYER	DR1622	PRELIMINARY RELEASE	2017-Oct-11	D.C.
B	M BOYER		REVISE SHAPE AND SIZE	2017-Nov-15	D.C.
C	M BOYER		UPDATE MATERIAL TREE AND TEXTURE INFO	2018-Feb-16	D.C.
D	R CRUZ		UPDATE NOTES, UPDATE OPTIONS TABLE	2018-Apr-23	

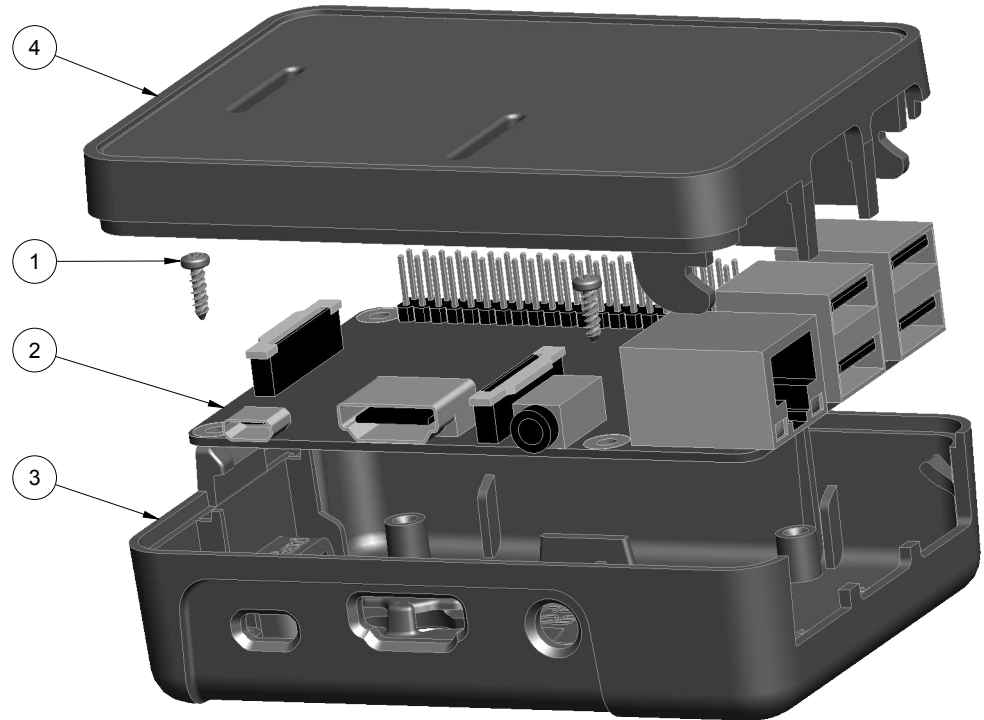

SCALE 1.000

PXX-382612 OPTIONS	
MATERIAL, COLOR	PREFIX
ABS, WHITE	P1A-
ABS, BLACK	P3A-
POLYCARBONATE, CLEAR	P0P-
POLYCARBONATE, SEMI-TRANSLUCENT DARK RED	P2P-
POLYCARBONATE, SEMI-TRANSLUCENT SMOKE GRAY	P4P-
POLYCARBONATE, SEMI-TRANSLUCENT BLUE	P7P-

THIRD ANGLE PROJECTION DO NOT SCALE DRAWING	TOLERANCES: UNLESS OTHERWISE SPECIFIED DIMENSIONS ARE IN U.S. INCHES. X.XX = .015 X.XXXX = .001 X.XXX = .010 X.X" = 1°	NEW AGE ENCLOSURES 2240 South Thornburg Street Santa Maria, CA. 93455 ph. (805) 595-1310 fax (805) 595-1024 www.newageenclosures.com
	CUSTOMER'S PART No: 382612	
APPROVAL BY DATE CHECK _____ ENG. _____ SCALE AS NOTED	DRAWN BY M BOYER	SIZE A
NOTICE: THE INFORMATION AND DATA CONTAINED HEREIN IS CONSIDERED PROPRIETARY TO ALLTEC INTEGRATED MFG INC & SHALL REMAIN THE EXCLUSIVE PROPERTY OF ALLTEC INTEGRATED MFG INC. THE HOLDER WILL ASSUME CUSTODY AND CONTROL THAT THIS DOCUMENT WILL NOT BE COPIED, REPRODUCED, OR DISCLOSED WITHOUT THE EXPRESS WRITTEN CONSENT OF ALLTEC INTEGRATED MFG INC. POSSESSION OF THIS DOCUMENT DOES NOT CONSTITUTE A GRANT TO MANUFACTURE ANY ITEMS. © 2018	DATE 2017-Oct-11	SHEET 1 OF 4
BILL OF MATERIALS		REV.DOC D

ITEM	FILE NAME	DESCRIPTION	MATERIAL	COLOR	QTY.
4	382612_COVER	382612 COVER - STANDARD	SEE TREE	SEE TREE	1
3	382612_BASE	382612 BASE - STANDARD	SEE TREE	SEE TREE	1
2	382612_PCB_RASPBERRY_PI3	RASPBERRY Pi 3 MODEL B	.050" THICK	CUSTOMER SUPPLIED	1
1	SCREW_HILO-N02X312	#2 HiLo x .312" SCREW	ZINK PLATED	5/16" LONG	4

382612 ASSEMBLY

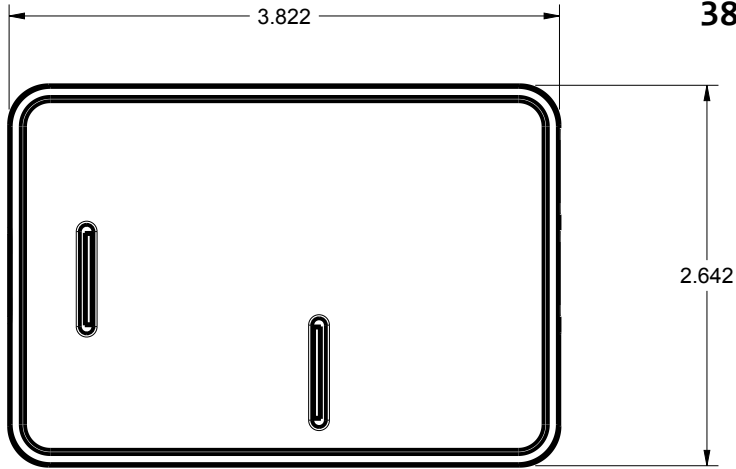

SCALE 0.750

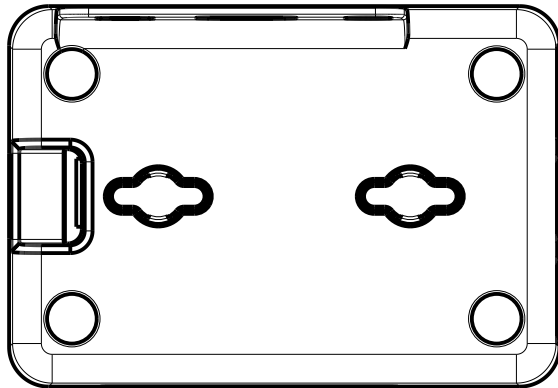
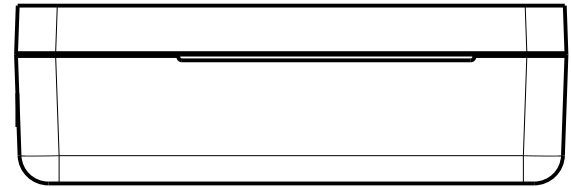
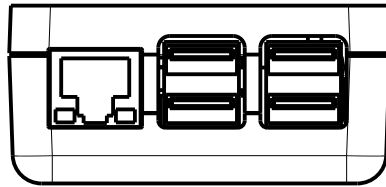
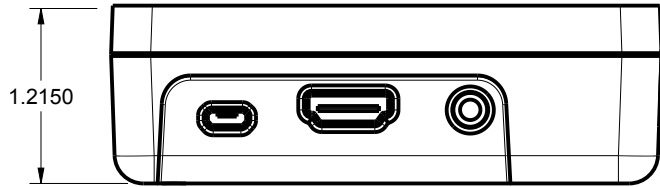

TOLERANCES: UNLESS OTHERWISE SPECIFIED
DIMENSIONS ARE IN U.S. INCHES.
X.XX = .015 X.XXXX = .001
X.XXX = .010 X.X° = 1°

NEW AGE ENCLOSURES
Customer's Part No: 382612

APPROVAL	BY	DATE
CHECK		
ENG.		
SCALE	AS NOTED	

DRAWN BY	2017-Oct-11
M BOYER	

NEW AGE ENCLOSURES
2240 South Thornburg Street Santa Maria, CA. 93455
ph. (805) 595-1310 fax (805) 595-1024
www.newageenclosures.com

RASPBERRY Pi 3 ENCLOSURE
PXX-382612-XXX

SIZE	DRAWING NAME	SHEET	REV.DOC
A	382612_RD	2 OF 4	D

382612 COVER

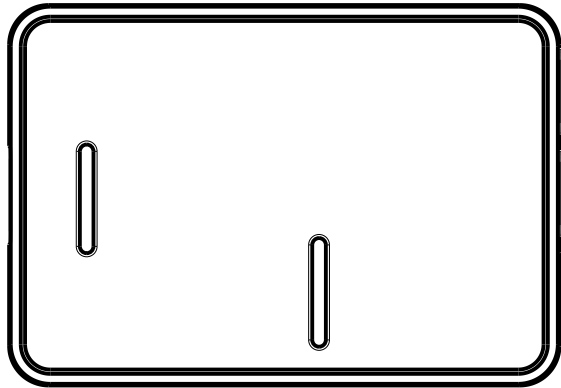
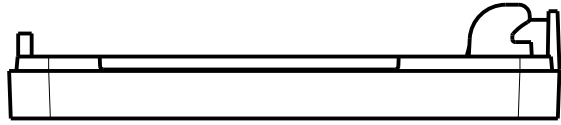

SCALE 0.750

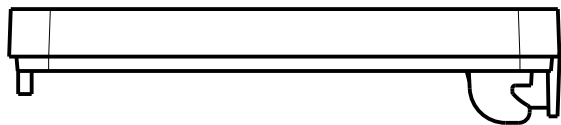
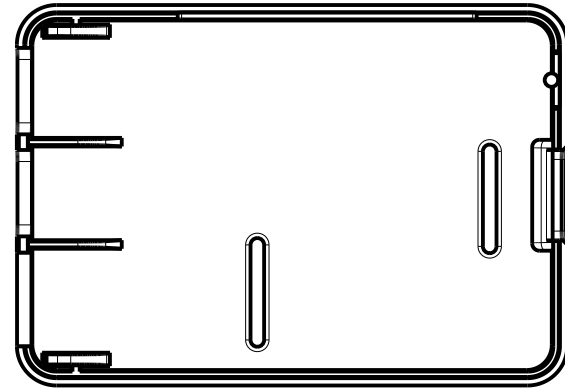
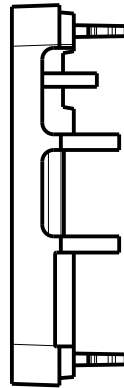

TOLERANCES: UNLESS OTHERWISE SPECIFIED
DIMENSIONS ARE IN U.S. INCHES.
X.XX = .015 X.XXXX = .001
X.XXX = .010 X.X° = 1°

NEW AGE ENCLOSURES

Customer's Part No: 382612

APPROVAL BY DATE

CHECK

ENG.

SCALE AS NOTED

DRAWN BY M BOYER 2017-Oct-11

NEW AGE ENCLOSURES

2240 South Thornburg Street Santa Maria, CA. 93455
ph. (805) 595-1310 fax (805) 595-1024
www.newageenclosures.com

RASPBERRY Pi 3 ENCLOSURE
PXX-382612-XXX

SIZE A DRAWING NAME 382612_RD SHEET 3 OF 4 REV.DOC D

382612 BASE

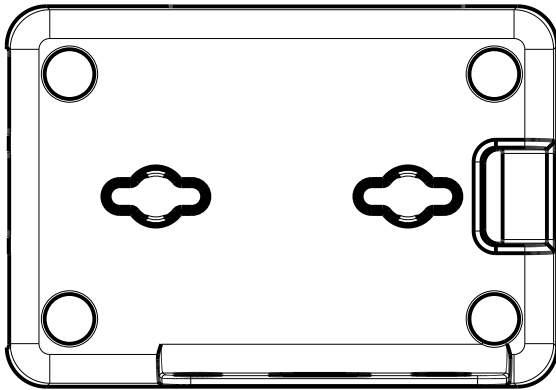
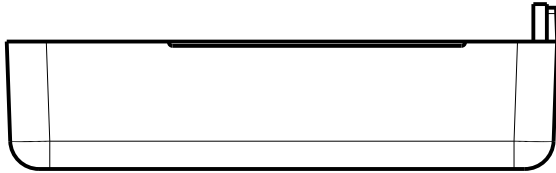

SCALE 0.750

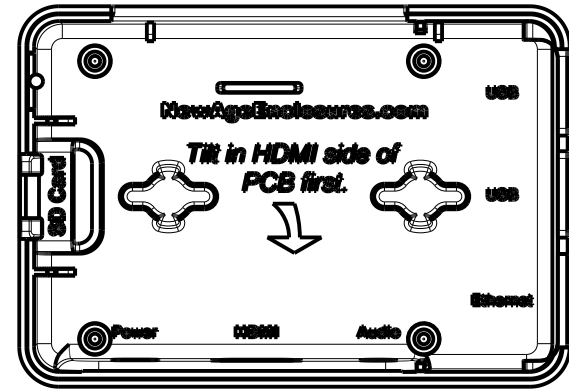
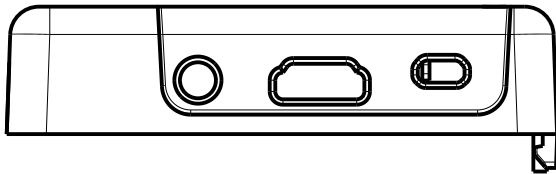
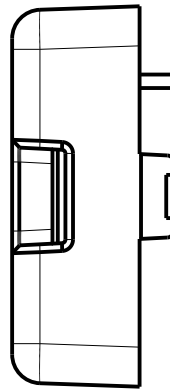

TOLERANCES: UNLESS OTHERWISE SPECIFIED
DIMENSIONS ARE IN U.S. INCHES.
X.XX = .015 X.XXXX = .001
X.XXX = .010 X.X° = 1°

NEW AGE ENCLOSURES

Customer's Part No: 382612

APPROVAL	BY	DATE
CHECK		
ENG.		
SCALE	AS NOTED	

DRAWN BY
M BOYER 2017-Oct-11

NEW AGE ENCLOSURES

2240 South Thornburg Street Santa Maria, CA. 93455
ph. (805) 595-1310 fax (805) 595-1024
www.newageenclosures.com

RASPBERRY Pi 3 ENCLOSURE
PXX-382612-XXX

SIZE A	DRAWING NAME 382612_RD	SHEET 4 OF 4	REV.DOC D
-----------	---------------------------	-----------------	--------------

X-ON Electronics

Largest Supplier of Electrical and Electronic Components

Click to view similar products for [Enclosures, Boxes & Cases](#) *category:*

Click to view products by [New Age](#) *manufacturer:*

Other Similar products are found below :

[585-R-WH-PK](#) [M-10-PLATED](#) [60221-01](#) [60566-01-000](#) [HPL-9VB BATT DOOR](#) [M18-PLTD](#) [M-21-PLATED](#) [63310-01-000](#) [6711GSKT](#)
[71884-29-028](#) [LH45-100 Black](#) [72868-510-000](#) [CNS-0000 Black](#) [72883-510-000](#) [CNS-0101 Black](#) [72906-510-000](#) [CNS-0407 Black](#) [73092-](#)
[510-000](#) [CNM-0101 Black](#) [73105-510-000](#) [CNL-0101 Black](#) [73108-510-000](#) [CNL-0303 Black](#) [73395-510-039](#) [CNS-0006 Bone](#) [74257-510-000](#)
[CNL-0004](#) [MDC-1183-PLAIN-ALUM](#) [MDC-1183-PTD](#) [MDC-13104-PTD](#) [MDC-321-PTD](#) [MDC-973-PTD](#) [76](#) [77153-01-028](#) [FLX6030](#)
[83535-01-508](#) [90026-501-000](#) [PS36-200](#) [116-508](#) [120-407](#) [120-910](#) [127-908](#) [130-008](#) [1301170079](#) [1322GSKTEP](#) [1325GSKT3](#) [138-PLAIN](#)
[1434-1210](#) [EAS-500 \(BLACK ANO\)](#) [1804RP-RB-PK](#) [190-005](#) [2202307](#) [KAB3321 BLACK](#) [KAB3421](#) [2697466](#) [S52213](#) [2901123](#) [2901699](#)
[A0645271](#) [A20P20](#) [2106-IR](#)