

NHD-4.3RTP-SHIELD-L

Color TFT Liquid Crystal Display Module + Arduino Shield

NHD-	Newhaven Display
4.3-	4.3" Diagonal
RTP-	4-wire Resistive Touch Panel with Controller
SHIELD-	Arduino Shield
L-	Display: NHD-4.3-480272EF-ATXL#-T, 6:00 Optimal View, Wide Temperature

Newhaven Display International, Inc.

2661 Galvin Ct.

Elgin IL, 60124

Ph: 847-844-8795

Fax: 847-844-8796

www.newhavendisplay.com

nhtech@newhavendisplay.com

nhsales@newhavendisplay.com

Document Revision History

Revision	Date	Description	Changed by
0	08/17/16	Initial Release	PB

Functions and Features

- 480xRGBx272 resolution, up to 262K colors
- Utilizes the FTDI FT800 Embedded Video Engine
- PWM backlight control
- Onboard audio power amplifier
- microSD card reader (microSD card not included)
- Built-in logic level shifting
- Assembled with NHD-4.3-480272EF-ATXL#-T
- 4-wire resistive Touch Panel

User Guide:

Please download User Guide at http://www.newhavendisplay.com/userguides/NHD-4.3RTP-SHIELD_User_Guide.pdf

Mechanical Drawing

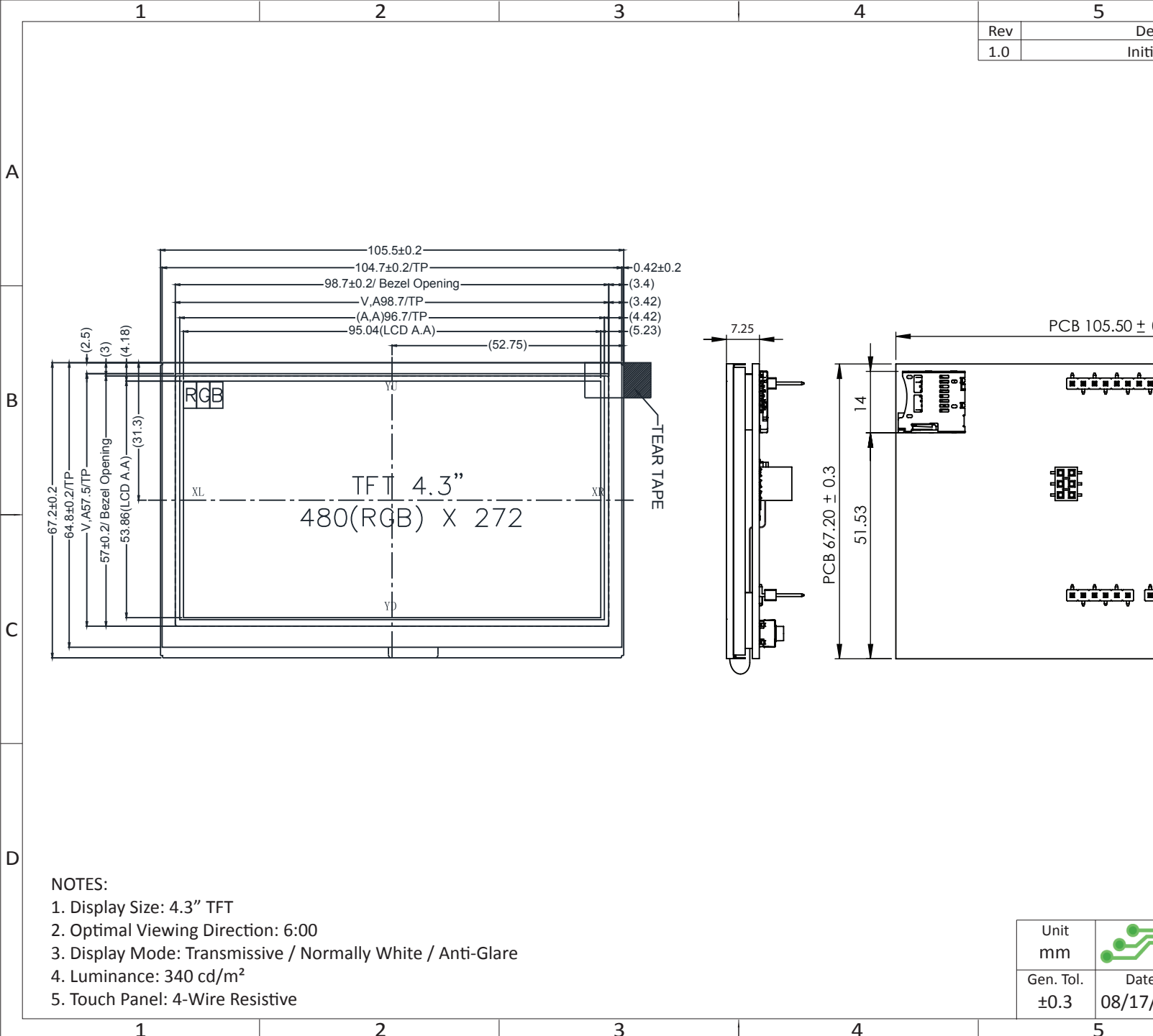

Schematic

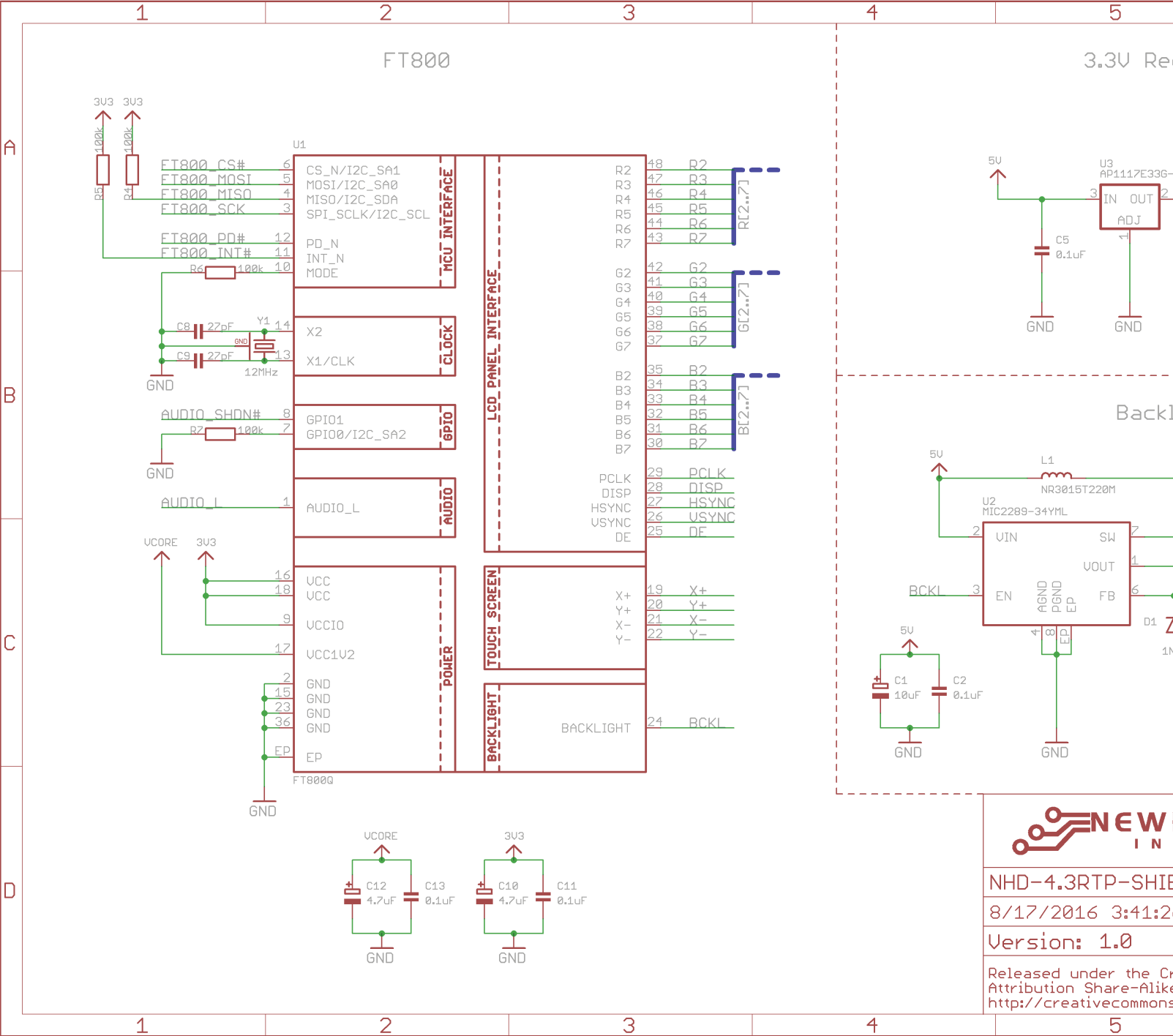

Schematic

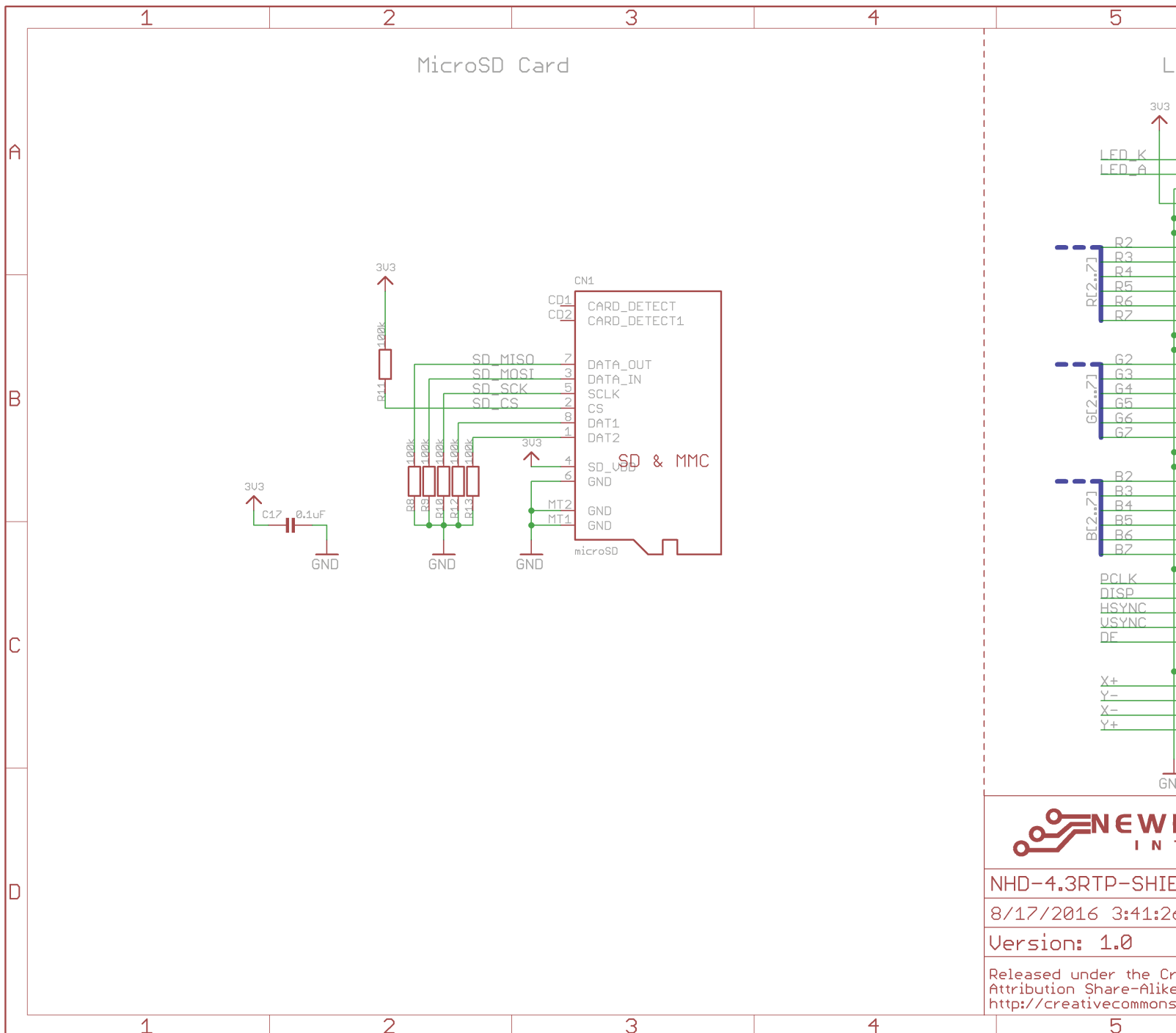

NHD-4.3RTP-SHIE

8/17/2016 3:41:20

Version: 1.0

Released under the Creative Commons Attribution-ShareAlike license
<http://creativecommons.org/licenses/by-sa/4.0/>

Schematic

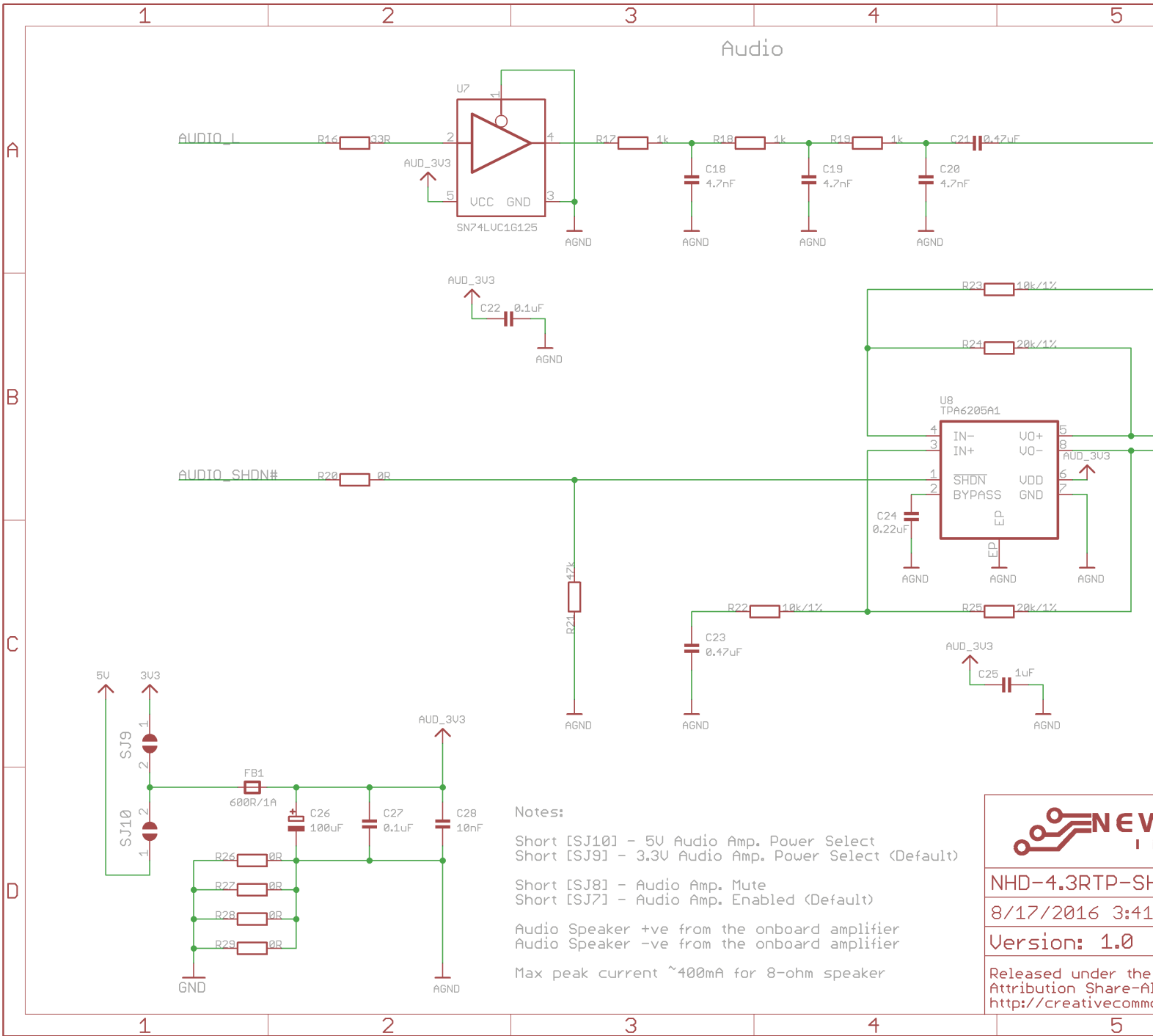

Notes:

- Short [SJ10] - 5V Audio Amp. Power Select
- Short [SJ9] - 3.3V Audio Amp. Power Select (Default)
- Short [SJ8] - Audio Amp. Mute
- Short [SJ7] - Audio Amp. Enabled (Default)

Audio Speaker +ve from the onboard amplifier
 Audio Speaker -ve from the onboard amplifier

Max peak current ~400mA for 8-ohm speaker



NHD-4.3RTP-SHIE
 8/17/2016 3:41:20
 Version: 1.0
 Released under the Creative Commons Attribution Share-Alike license
<http://creativecommons.org/licenses/by-sa/4.0/>

Schematic

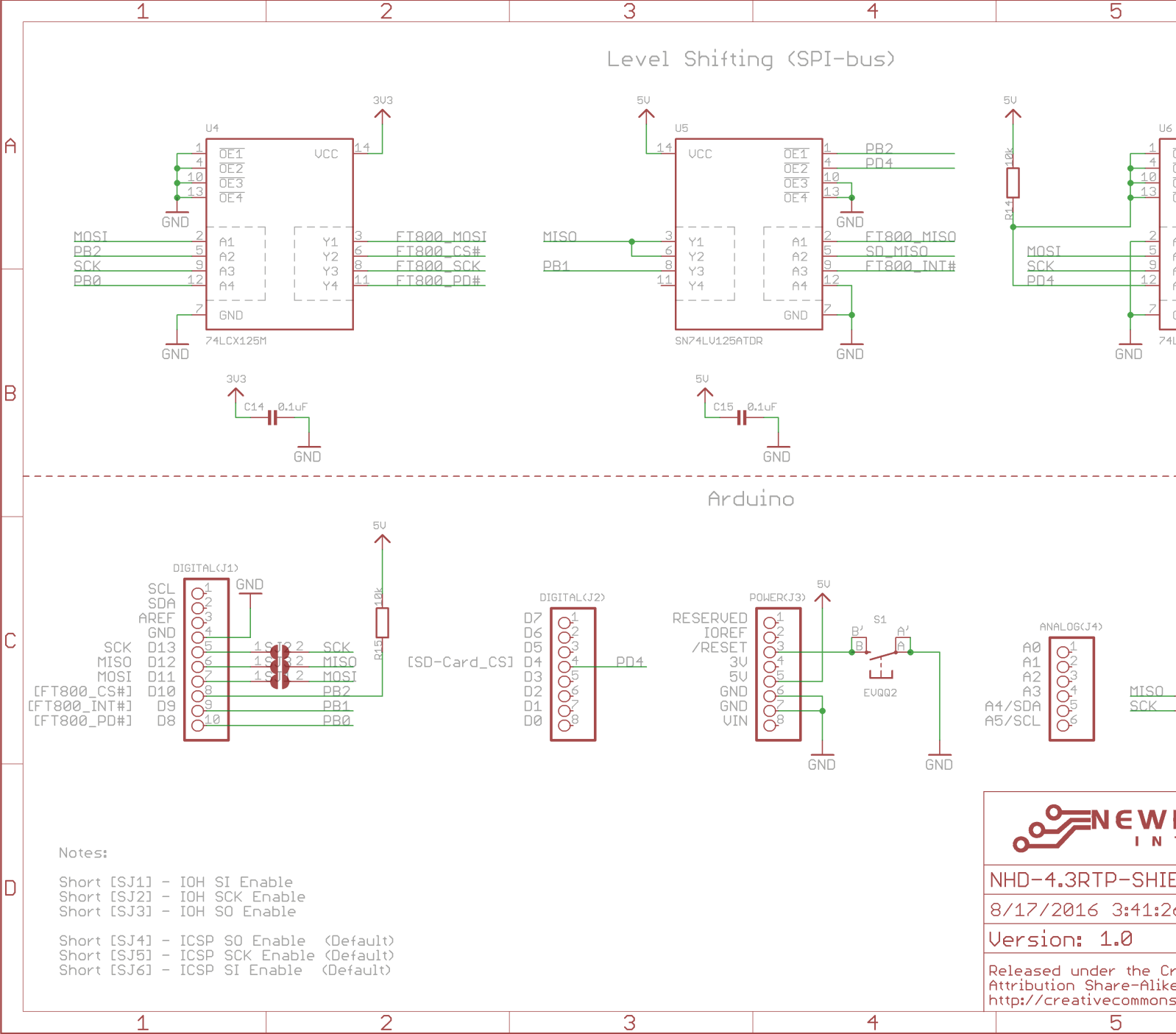

Notes:

- Short [SJ1] - IOH SI Enable
- Short [SJ2] - IOH SCK Enable
- Short [SJ3] - IOH S0 Enable
- Short [SJ4] - ICSP S0 Enable (Default)
- Short [SJ5] - ICSP SCK Enable (Default)
- Short [SJ6] - ICSP SI Enable (Default)

NHD-4.3RTP-SHIE
 8/17/2016 3:41:20
 Version: 1.0
 Released under the Creative Commons Attribution Share-Alike license
<http://creativecommons.org/licenses/by-sa/4.0/>

Pin Description

Arduino UNO Pin Symbol	Function Description
J1 Interface	
SCL	No Connect
SDA	No Connect
AREF	No Connect
GND	Ground
13	No Connect (Short SJ2 for SPI SCK signal)
12	No Connect (Short SJ3 for SPI MISO signal)
11	No Connect (Short SJ1 for SPI MOSI signal)
10	FT801 Active LOW Chip Select signal
9	FT801 Active LOW Host Interrupt signal
8	FT801 Active LOW Power Down signal
J2 Interface	
7	No Connect
6	No Connect
5	No Connect
4	microSD Active LOW Chip Select signal
3	No Connect
2	No Connect
1	No Connect
0	No Connect
J3 Interface	
RESERVED	No Connect
IOREF	No Connect
RESET	No Connect
3.3V	No Connect
5V	Supply Voltage for Module (+5V)
GND	Ground
GND	Ground
Vin	No Connect
J4 Interface	
A0	No Connect
A1	No Connect
A2	No Connect
A3	No Connect
A4	No Connect
A5	No Connect
J5 Interface	
MISO	SPI MISO signal (Default)
5V	No Connect
SCK	SPI SCK signal (Default)
MOSI	SPI MOSI signal (Default)
RESET	No Connect
GND	Ground

Electrical Characteristics

Item	Symbol	Condition	Min.	Typ.	Max.	Unit
Operating Temperature Range	T _{OP}	Absolute Max	-20	-	+70	°C
Storage Temperature Range	T _{ST}	Absolute Max	-30	-	+80	°C
Supply Voltage	V _{DD}	-	4.8	5.0	5.5	V
Supply Current	I _{DD}	V _{DD} = 5V	-	250	340	mA
"H" level input	V _{IH}	-	2.2	-	V _{DD}	V
"L" level input	V _{IL}	-	GND	-	0.8	V

Optical Characteristics

Item	Symbol	Condition	Min.	Typ.	Max.	Unit
Optimal Viewing Angles	Top	CR ≥ 10	-	50	-	°
	Bottom		-	70	-	°
	Left		-	70	-	°
	Right		-	70	-	°
Contrast Ratio	Cr	-	400	500	-	-
Luminance	Lv	I _{LED} = 40 mA	-	340	-	cd/m ²
Response Time	Rise	T _{OP} = 25°C	-	25	30	ms
	Fall		-	25	30	ms

Touch Panel Characteristics

Item	Min.	Typ.	Max.	Unit
Linearity	-1.5	-	1.5	%
Circuit Resistance – X-Axis	350	-	1050	Ω
Circuit Resistance – Y-Axis	100	-	450	Ω
Insulation Resistance	20	-	-	MΩ
Operating Voltage	-	-	10	V
Chattering	-	-	15	ms
Transmittance	80	-	-	%
Activation Force	20	-	80	g
Pen Writing Durability	100,000	-	-	Characters
Pitting Durability	1,000,000	-	-	Touches
Surface Hardness	3	-	-	H
Haze	4	7	10	%

Controller Information

TFT Controller:

Built-in FTDI FT800 Embedded Video Engine.

Please download specification at http://www.ftdichip.com/Support/Documents/DataSheets/ICs/DS_FT800.pdf

Display Information

TFT:

NHD-4.3-480272EF-ATXL#-T – Standard 4.3" TFT, 480x272 Pixels, 24-bit Parallel RGB Interface, w/ 4-wire Resistive Touch Panel.

Please download specification at <http://www.newhavendisplay.com/specs/NHD-4.3-480272EF-ATXL-T.pdf>

Block Diagram

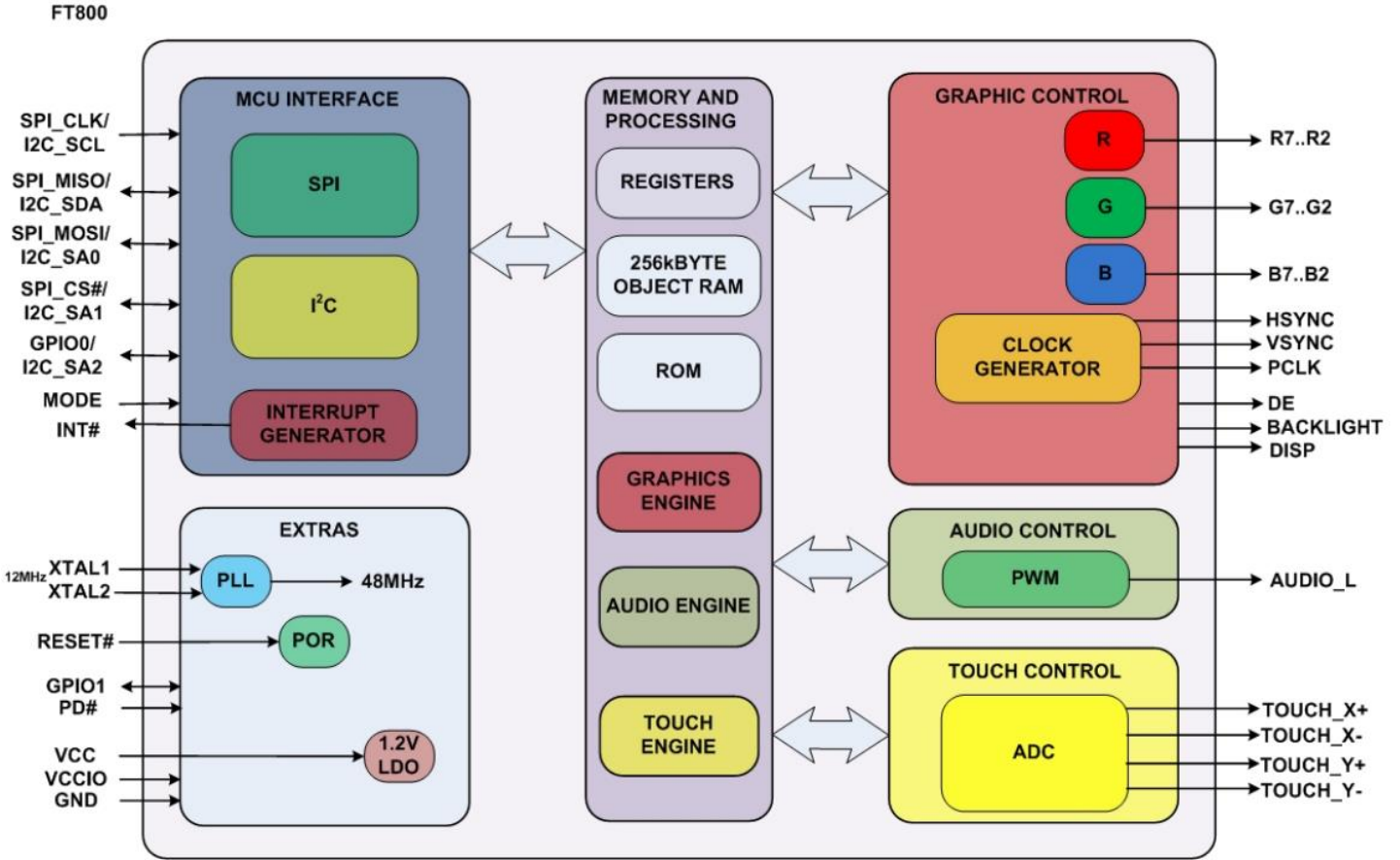

Host Interface

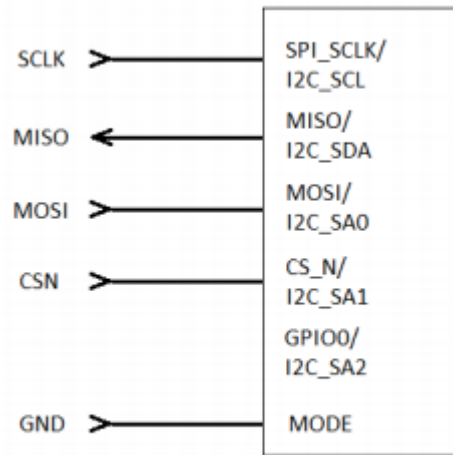

SPI Interface Connection

SPI Interface – The SPI slave interface operates up to 30MHz. Only SPI mode 0 is supported. The SPI interface is selected by default (MODE pin is internally pulled low by a 100k resistor).

Timing Characteristics

SPI Interface:

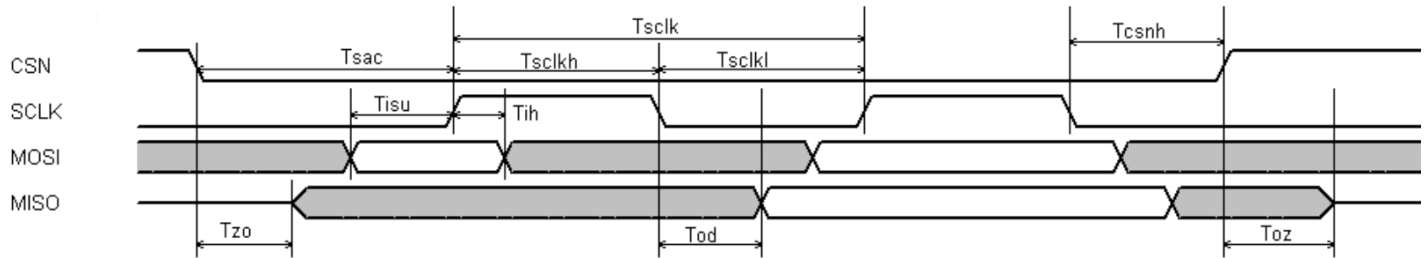

Parameter	Description	VCC(I/O)=1.8V		VCC(I/O)=2.5V		VCC(I/O)=3.3V		Units
		Min	Max	Min	Max	Min	Max	
T_{sc}	SPI clock period	60	-	40	-	33	-	ns
T_{scLl}	SPI clock low duration	25	-	16	-	13	-	ns
T_{scLh}	SPI clock high duration	25	-	16	-	13	-	ns
T_{sac}	SPI access time	16	-	16	-	16	-	ns
T_{isu}	Input Setup	12	-	11	-	11	-	ns
T_{ih}	Input Hold	3	-	3	-	3	-	ns
T_{zo}	Output enable delay	0	30	0	20	0	16	ns
T_{oz}	Output disable delay	0	30	0	20	0	16	ns
T_{od}	Output data delay	0	24	0	15	0	12	ns
T_{csnh}	CSN hold time	0	-	0	-	0	-	ns

For more information about FT801 controller please go to official FT800 Datasheet.

http://www.ftdichip.com/Support/Documents/DataSheets/ICs/DS_FT800.pdf

Quality Information

Test Item	Content of Test	Test Condition	Note
High Temperature storage	Endurance test applying the high storage temperature for a long time.	+80°C , 96hrs	2
Low Temperature storage	Endurance test applying the low storage temperature for a long time.	-30°C , 96hrs	1,2
High Temperature Operation	Endurance test applying the electric stress (voltage & current) and the high thermal stress for a long time.	+70°C , 96hrs	2
Low Temperature Operation	Endurance test applying the electric stress (voltage & current) and the low thermal stress for a long time.	-20°C , 96hrs	1,2
High Temperature / Humidity Operation	Endurance test applying the electric stress (voltage & current) and the high thermal with high humidity stress for a long time.	+60°C , 90% RH , 96hrs	1,2
Thermal Shock resistance	Endurance test applying the electric stress (voltage & current) during a cycle of low and high thermal stress.	-20°C,30min -> 25°C,5min ->70°C,30min = 1 cycle 10 cycles	
Vibration test	Endurance test applying vibration to simulate transportation and use.	10-55Hz , 15mm amplitude. 60 sec in each of 3 directions X,Y,Z For 15 minutes	3
Static electricity test	Endurance test applying electric static discharge.	VS=800V, RS=1.5kΩ, CS=100pF One time	

Note 1: No condensation to be observed.

Note 2: Conducted after 4 hours of storage at 25°C, 0%RH.

Note 3: Test performed on product itself, not inside a container.

Precautions for using LCDs/LCMs

See Precautions at www.newhavendisplay.com/specs/precautions.pdf

Warranty Information

See Terms & Conditions at http://www.newhavendisplay.com/index.php?main_page=terms

X-ON Electronics

Largest Supplier of Electrical and Electronic Components

Click to view similar products for [Display Development Tools](#) category:

Click to view products by [Newhaven Display](#) manufacturer:

Other Similar products are found below :

[KIT 60121-3](#) [S5U13U11P00C100](#) [MAX14521EEVKIT](#) [121CBL02-RPK](#) [KIT 60145-3](#) [S5U13748P00C100](#) [DFR0413](#) [3248](#)
[DLPLCR90EVM](#) [DLPLCR50XEVM](#) [MAX20069EVKIT#](#) [KIT95000-3](#) [LCD-16396](#) [PIM370](#) [1109](#) [MCIMX-LVDS1](#) [MIKROE-2449](#)
[MIKROE-2453](#) [131](#) [DEV-13628](#) [1590](#) [MIKROE-2269](#) [1601](#) [1770](#) [1947](#) [1983](#) [1987](#) [2050](#) [2218](#) [2219](#) [2260](#) [2345](#) [2418](#) [2423](#) [2454](#) [2455](#)
[2478](#) [2674](#) [SK-220RD-PI](#) [FIT0477](#) [333](#) [334](#) [TE-M321-SDK](#) [DFR0428](#) [cs-epapersk-03](#) [338](#) [DEV-14442](#) [FIT0478](#) [cs-paperino-01](#) [OM-E-OLE](#)