

惠州市鑫永诚光电科技有限公司
Huizhou Newopto Photoelectric Technology Co., Ltd.

产品承认书
SPEC FOR APPROVAL

客户名称 Customer	
产品型号 Model	XYC-PT0805BC-L4-D
承认编号 Part No.	PT329-A
编制日期 Edit Date	2022-10-05
版本 Edition	A0

核准(Approval)	审核(Check)	编制(Edit)
谭起富	丁杰	彭超

客户确认(Customer Signatures)		

地址：惠州市仲恺高新区潼侨镇宏村宏川路鑫永诚科技园

Address: Newopto Technology Zone, Hongchuan road, Hong village, Tongqiao town, Zhongkai High tech Zone, Huizhou city, Guangdong, China

电话(Tel): 0752—7987222

网址(Web site): <http://www.xycgd.com>

传真(Fax): 0752—7987000

邮箱(E-mail): xycgd888@163.com

目录 Contents

封面 cover	1
产品信息 Product information	3
额定参数 Absolute Maximum Ratings (Ta=25°C).....	3
光电特性 Elector-Optical Characteristics (Ta=25°C).....	4
可靠性试验 Reliability Test	5
光电特性曲线 Typical photoelectric characteristics curves.....	6
应用电路 Application circuit	7
产品外型尺寸 Size of products and dimensions.....	9
包装规格 Packing Specification.....	10
焊接 Soldering.....	12
使用注意事项 Precautions	14

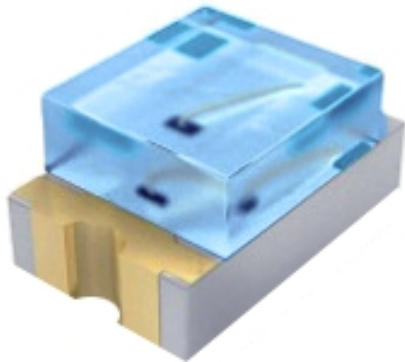

鑫永诚 PT550 系列红外环境光感测器是一款高灵敏度的光敏传感器，贴片式外型封装，体积小，高可靠性，既节能又环保，应用领域广，可取代传统 CDS 使用，也可以用于产品对射及反射使用。

NEW PTO PT550 series ALS is a high sensitivity of the photosensitive sensor, SMD package, small size, high reliability, energy saving and environmental protection, wide application field, it can replace the traditional CDS use, can also be used for product use on the radio and reflection.

特性 Features

- 1) 感光峰值波长 550nm Photosensitive peak wavelength $\lambda_p=550\text{nm}$
- 2) 高可靠性 High reliability
- 3) 低功耗 Low Power Consumption
- 4) 符合 RoHS RoHS compliant

应用 Applications

- 1) 替代传统 CDS 光敏电阻 Replacement of conventional CDS photosensitive resistors
- 2) 适用于各类光控照明产品：如小夜灯等 Suitable for all kinds of light products: such as night lamp etc.
- 3) 自动调节背景光：如 LCD、手机、照像机、电脑摄像头等 Products which need to adjust background light automatically, LCD, mobile phone, camera, computer camera etc.
- 4) 控制各类光控影控玩具 Control all kinds of light and shadow controlled toys
- 5) 各类光控红外检测测试设备等 All kinds of infrared light detection and testing equipment

量身订制 Customization

- 1) 品种齐全,生产周期短,小批量库存备货
Complete varieties, short production cycle , small batch inventory
- 2) 可按要求提供不同外型,角度, 方便安装于产品的任何位置
Customize different shapes and angles
- 3) 可按需求提供最佳的规格, 以便让产品效果更好, 更具市场竞争力
Customize most suitable specifications to make the product be more competitive

额定参数 Absolute Maximum Ratings (Ta=25°C)

电气特性 Electrical characteristics	符号 Symbol	额定值 Rated Value	单位 Unit
集电极—发射极电压 Collector-emitter Breakdown Voltage	V _{CEO}	30	V
发射极—集电极电压 Emitter-Collector Breakdown Voltage	V _{ECO}	3	V
功耗 Power	PC	70	mW
工作温度 Operating Temperature	T _{opr}	-30--+85	°C
储存温度 Storage Temperature	T _{stg}	-40--+100	°C

光电特性 Elector-Optical Characteristics (Ta=25°C)

参数 Parameter	符号 Symbol	测试条件 Test Condition	最小 Min	典型 Typ	最大 Max	单位 Unit
感光峰值波长 Photosensitive peak wavelength	λ_p	\	--	550	--	nm
感光波宽范围 Sensitivity wave width	λ	\	400	--	700	nm
集电极—发射极电压 Collector-emitter Breakdown Voltage	B _{vceo}	I _C =100 μ A E _e =0mW/cm ²	30	--	--	V
发射极—集电极电压 Emitter-Collector Breakdown Voltage	B _{veco}	I _E =10 μ A E _e =0mW/cm ²	3	--	--	V
集电极发射极饱和电压 Collecto Emitter saturation voltage	V _{ce} (sat)	I _C =2mA E _e =1mW/cm ²	--	--	0.2	V
光电流 Photocurrent	IL(1)	V _{CE} =5V v=10Lux	--	2.5	3.5	μ A
	IL(2)	V _{CE} =5V v=30Lux	--	7.5	10.5	μ A
	IL(3)	V _{CE} =5V v=100Lux	--	25	35	μ A
暗电流 Dark current	I _D	V _{CC} =5V E _v =0Lux	--	--	0.2	μ A
开启时间 Opening time	t _r	V _{CE} =5V I _C =1mA	15			us
关闭时间 Closing time	t _f	RL=1000 Ω	15			us

可靠性试验 Reliability Test

测试项目 Test Parameter	参考标准 Reference Criterion	测试条件 Test Condition	时间 Time	样品数 Quantity	Ac/Re
耐焊接热 Resistance to Solder Heat	JESD22-B106	260°C±5°C	10 sec	22PCS	0/1
冷热循环 temperature cycle	JESD22-A104	+100°C(15min) 5min -10°C(15min)	50 cycles	22PCS	0/1
冷热冲击 Thermal Shock	JESD22-A104	+105°C(30min) 5min -45°C(30min)	50 cycles	22PCS	0/1
高温贮存 High Temperature storage	JESD22-A103	+100°C	1000H	22PCS	0/1
低温贮存 Low Temperature storage	JESD22-A119	-40°C	1000H	22PCS	0/1
寿命测试 Operating Life	JESD22-A108	VCE=5V	1000H	22PCS	0/1
高温高湿 High Temperature and High Humidity Test	JESD22-A101	85°C&85%R.H	168H	22PCS	0/1

光电特性曲线 Typical photoelectric characteristics curves

感光特性曲线 Photographic property Curve



图 1-1 — Photoreceptor curve — XYC/PT850 — Visible light sensor curve

暗电流随温度变化曲线图 Environment temperature VS Dark current



应用电路 application circuit

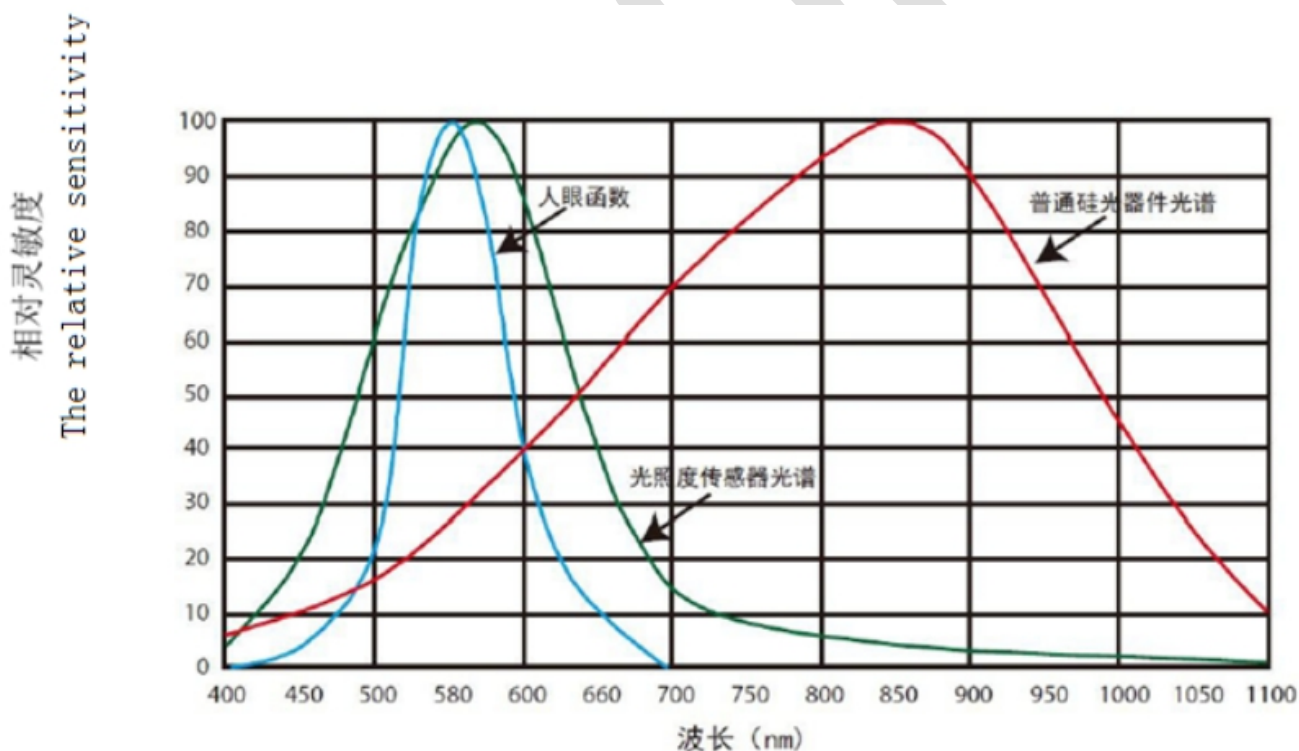
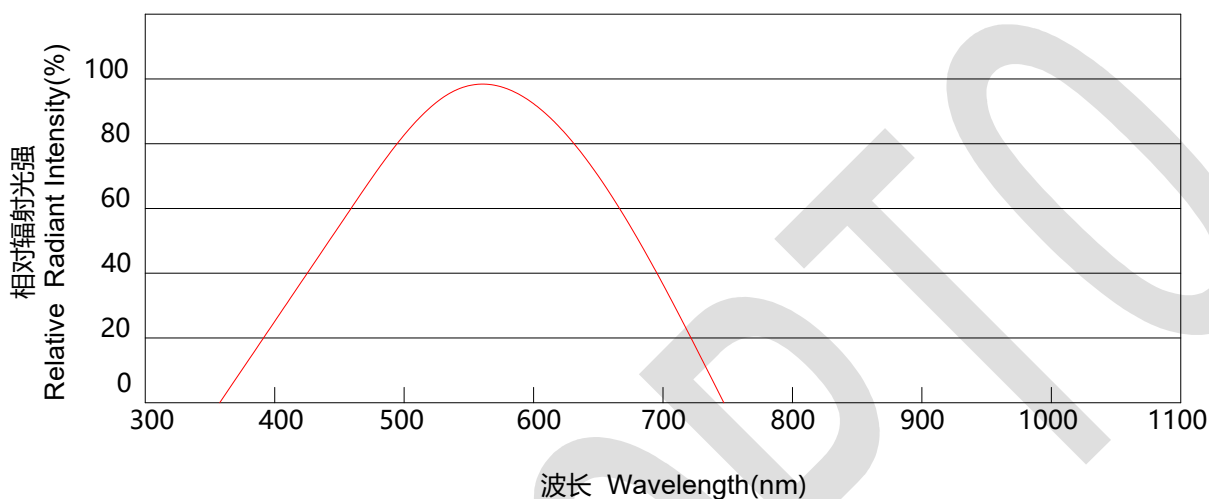
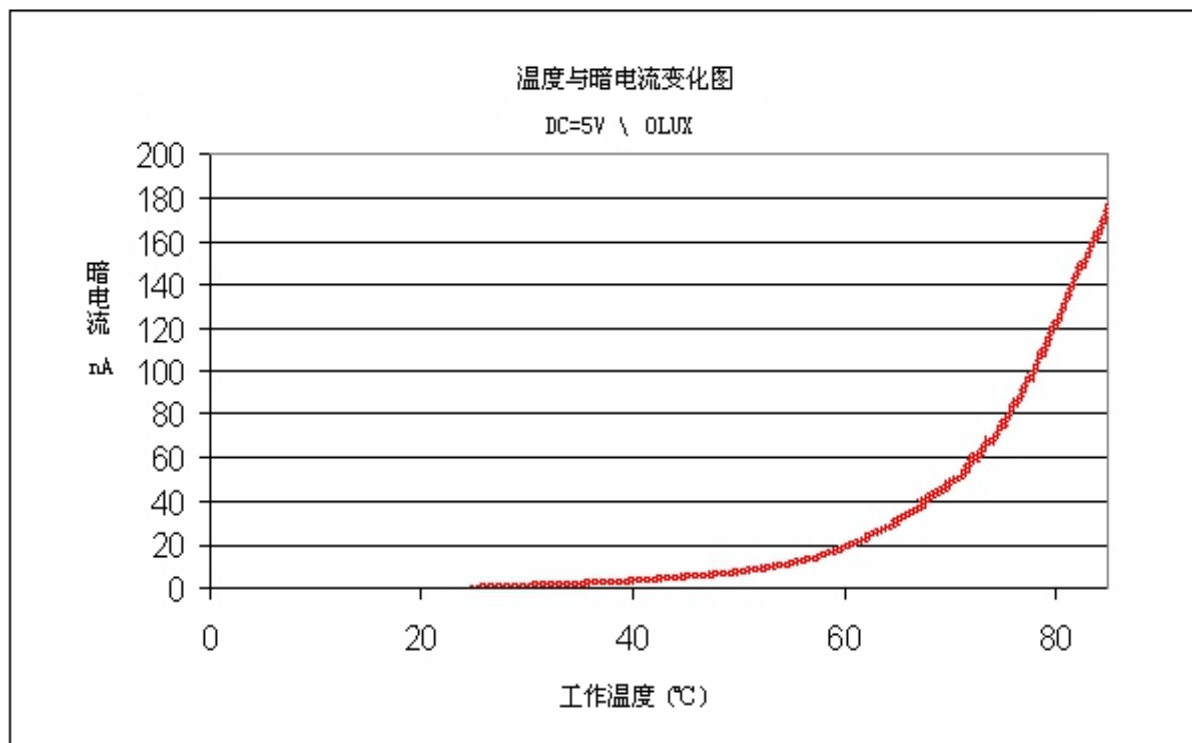
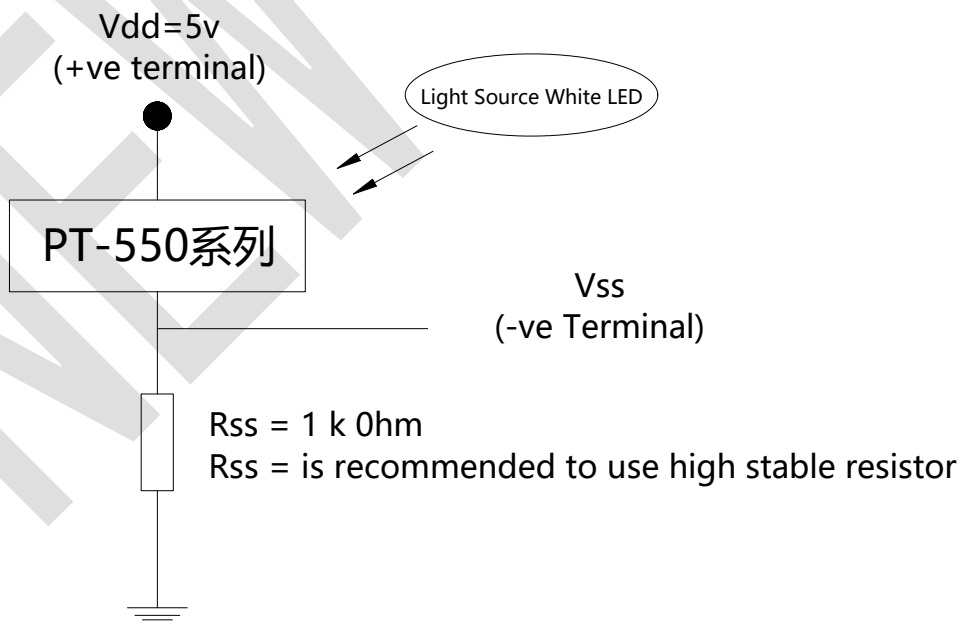

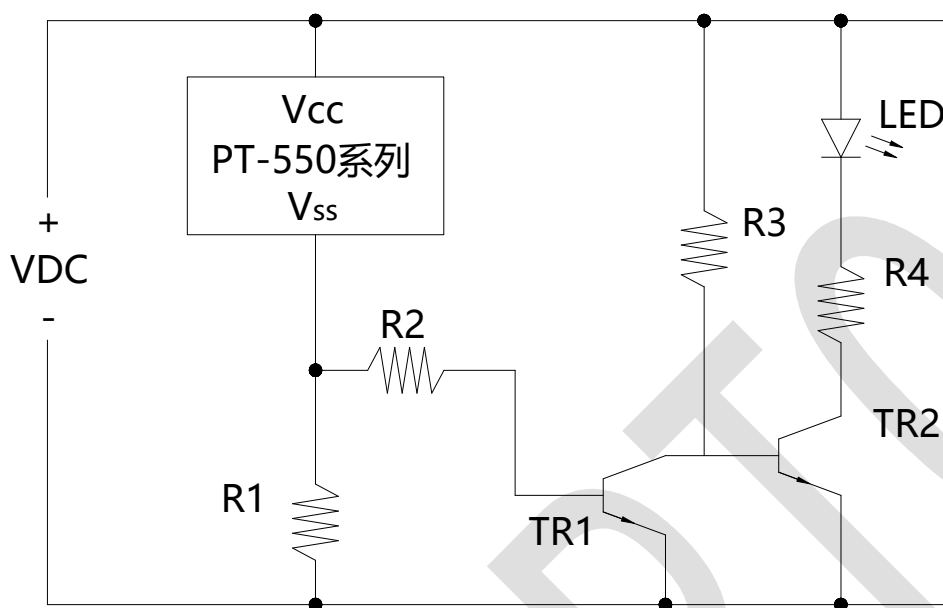

当光照低于光照阈值时，TR1三极管关闭，TR2三极管导通，LED导通。当环境光照大于光照阈值时，TR1降低的电流并使TR2截止，LED不导通。

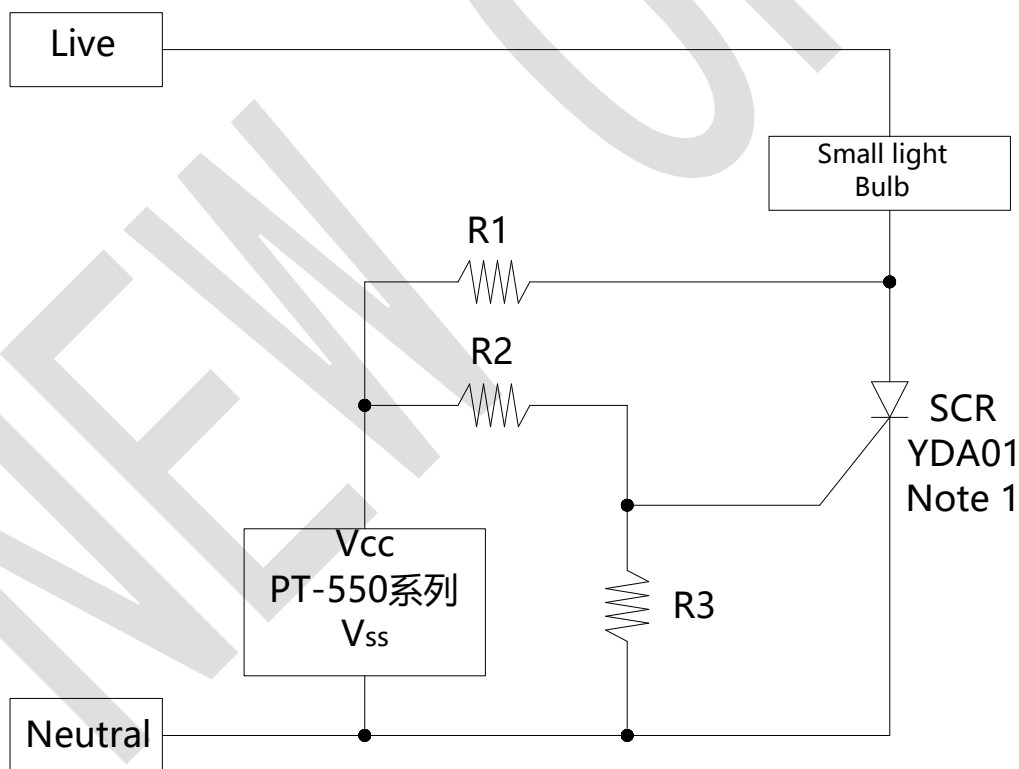

该电路需要一个敏感的可控硅。灯泡的电流是由敏感的可控硅开关空置。当光量超过阈值时，该Vdd与Vss引脚之间的电流转移了可控硅的栅极电流。光切换阈值可通过选择R2和R3不同的值进行调整。

产品外型尺寸 Package outline dimensions

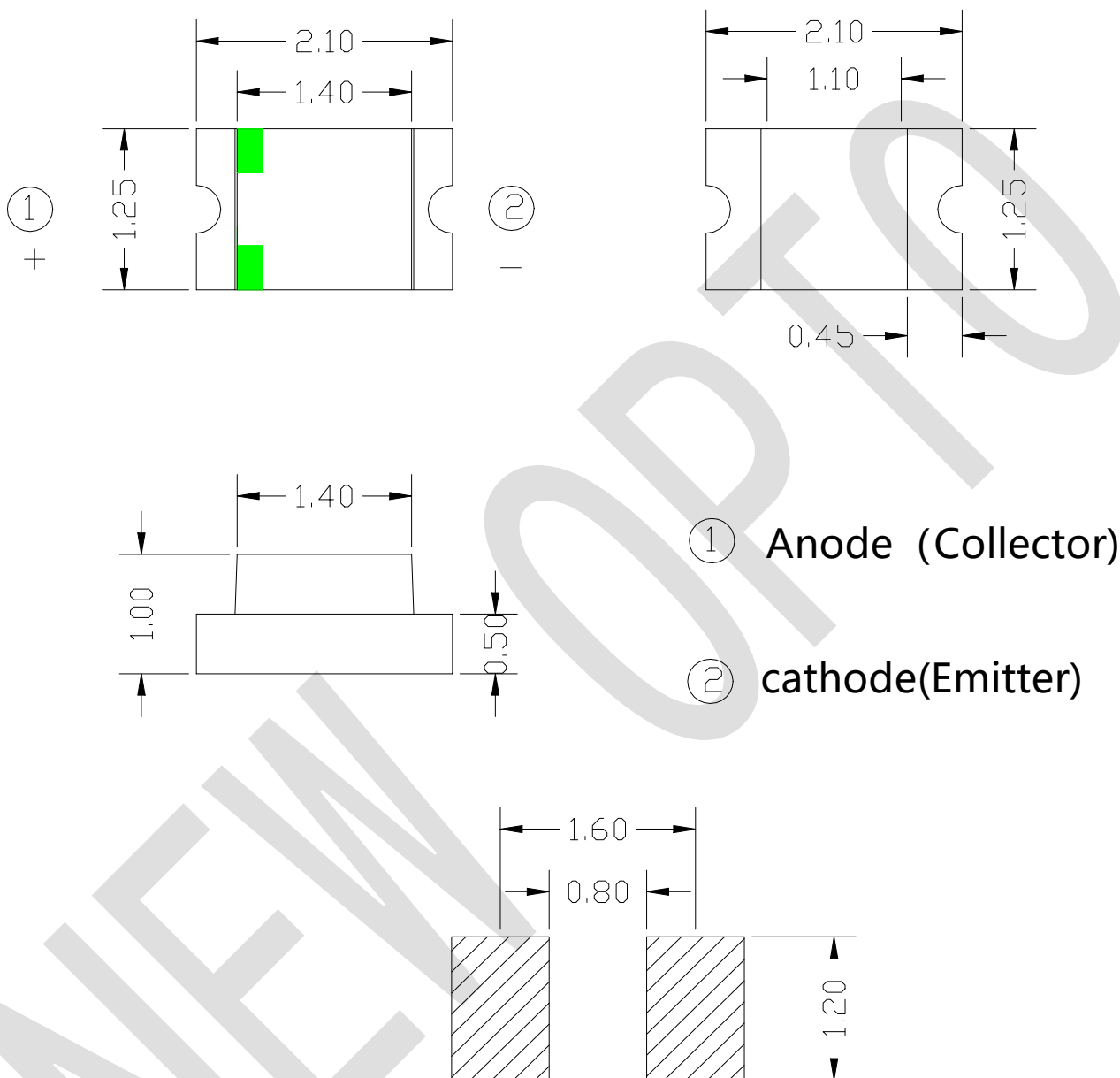

推荐焊盘尺寸
Recommended Solder Pad Design

备注：所有尺寸单位均为 mm，如无特殊说明误差范围为±0.15mm

Note: All dimensions in mm, tolerance is ±0.15mm unless otherwise noted

包装规格 Packing Specification

■ 标签规格 Label specification

 惠州市鑫永诚光电科技有限公司 鑫永诚光电	
Tel: 0752-7987222 Fax: 0752-7987000 http://www.xycgd.com	
料号	Material Number
型号	Model Number
单号	Lot.Number
箱号	Box Number
数量	Quantity
日期	Date

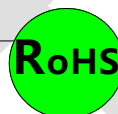

■ 卷轴尺寸 Reel Dimensions

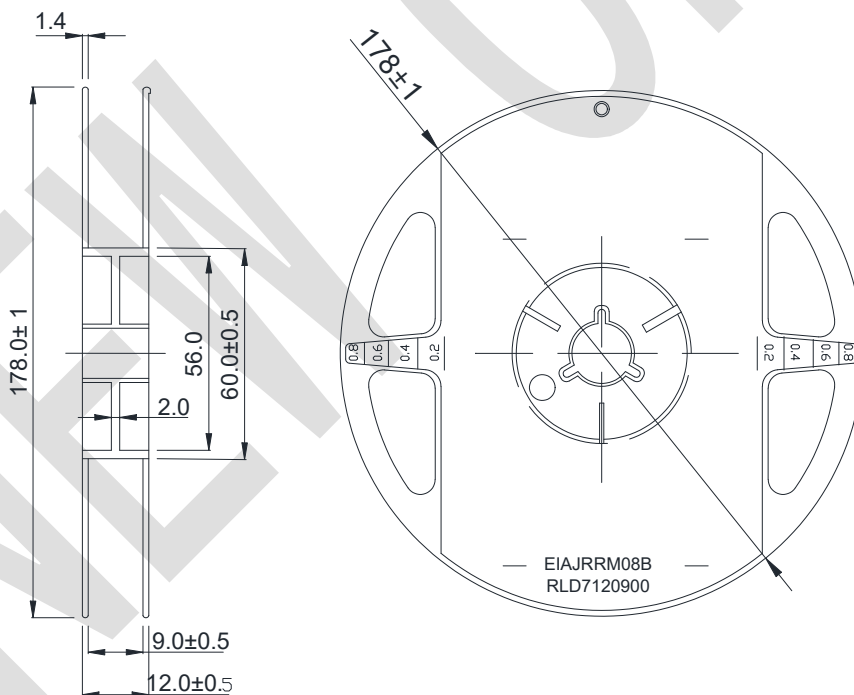

备注：若无特别标注，图中尺寸公差为±0.1mm，单位=mm

Note: Tolerance s unless mentioned ±0.01mm. Unit=mm

■ 卷盘规格 Carrier Tape

编带 3000pcs/卷 Quantity 3000 pcs Per Reel

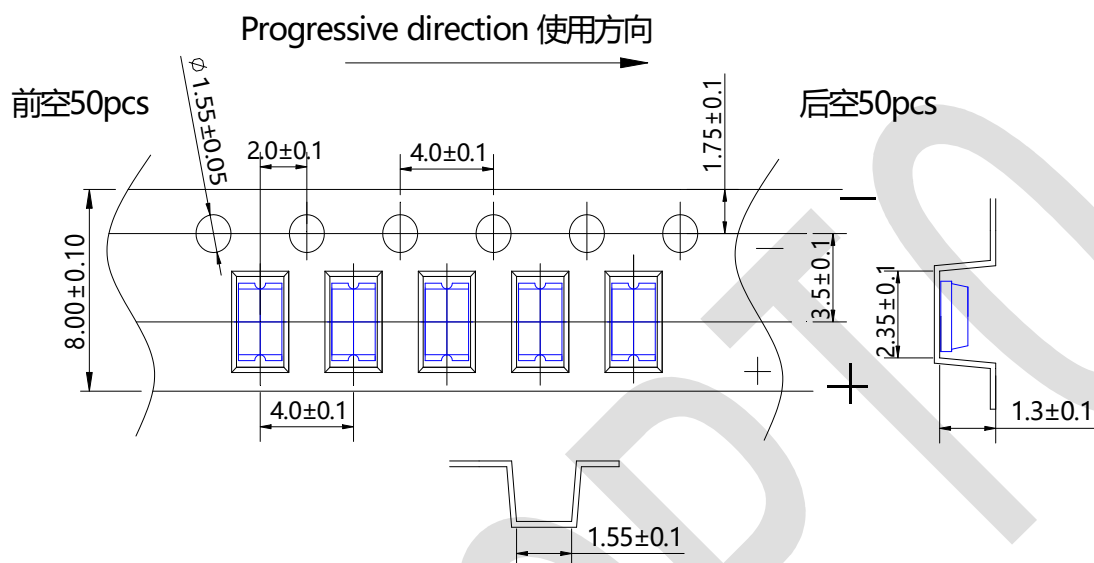

■ 包装步骤 Moisture Resistant Packing Process

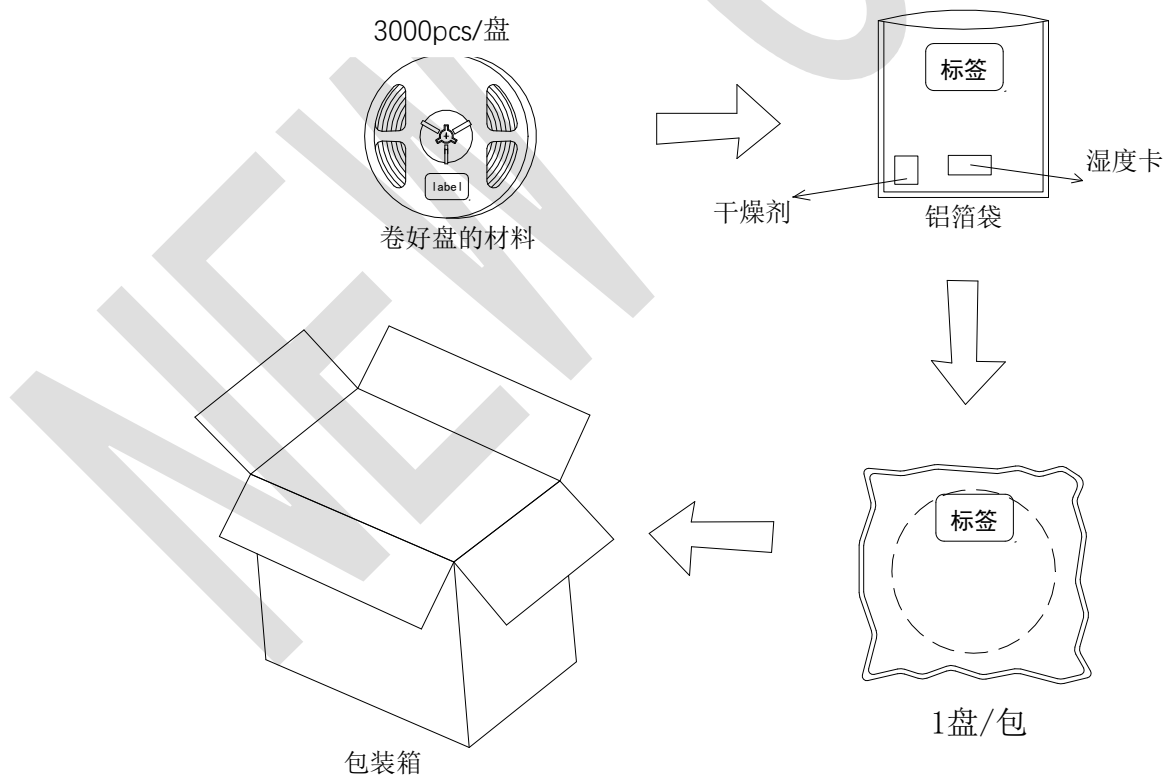

■ **回流焊 Reflow**

- 回流焊接：推荐使用以下无铅回流焊接温度图进行

Reflow Soldering: Use the conditions shown in the under Figure of PB-Free Reflow Soldering.

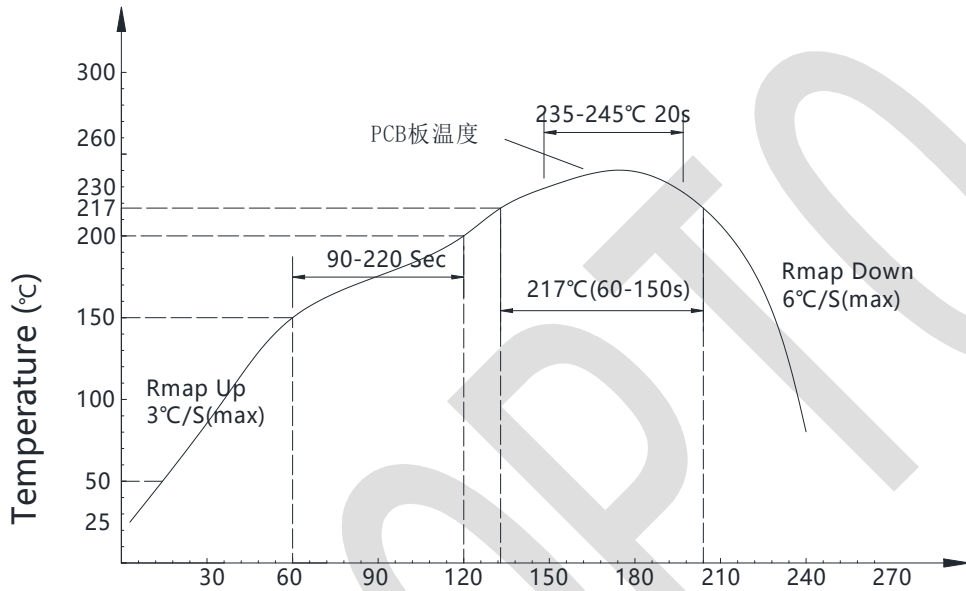

■ **回流焊接 Reflow Soldering**

- 回流焊次数不可以超过一次，否则 ALS 可能损坏。

Reflow soldering should not be done more than once, or ALS will be damaged.

- 当焊接时，不要在材料受热时用力压胶体表面。

When soldering, do not put stress on the ALS during heating.

- 建议回流链速：80-100cm/min（回流炉以 8 温区为基准，温区越多建议使用链速更快）

Please be sure the speed of the chain is 80-100cm/min (The reflow furnace is based on 8 temperature zone, the more temperature zone, the faster speed of the chain is recommended.)

■ **烙铁焊接 Soldering iron**

- 如使用手工焊接，建议使用小于 25 瓦的电烙铁，烙铁温度必须空置在 300°C 以下，焊接时间需控制在 3 秒钟以内，且每个点击只能焊接一次。

If manual soldering is used, the use of a soldering iron of less than 25W is recommended, and the temperature of the iron must be kept below 300°C, with soldering time within 2 seconds.

- 当焊接时，不要在材料受热时用力压胶体表面。

When soldering, do not put stress on the ALSes during heating

- 手工焊接只可焊接一次。

The hand solder should be done only one time

- 器件外部温度在 40°C 以下时，才可以对其进行处理。避免高温时操作对 ALS 造成损伤。

Handling of the SMD ALS should be done when the package has been cooled down to below 40°C or less. This is to prevent ALS failures due to thermal-mechanical stress during handling.

■ 清洗 Cleaning

- 在焊接后推荐使用酒精进行清洗，在温度不高于 30°C 的条件下持续 3 分钟，不高于 50°C 的条件下持续 30 秒。使用其他类似溶剂清洗前，请先确认使用的溶剂不会对 ALS 的封装和环氧树脂部分造成损伤。

It is recommended that alcohol be used as a solvent for cleaning after soldering. Cleaning is to go under 30°C for 3 minutes or 50°C for 30 seconds. When using other solvents, it should be confirmed beforehand whether the solvents will dissolve the package and the resin or not.

■ 修补 Repairing

- ALS 回流焊后不应该修复，当修复是不可避免时，必须使用双头烙铁，但必须事先确认此种方式会或不会损坏 ALS 本身的特性。

Repair should not be done after the ALSes have been soldered. When repairing is unavoidable, a double-head soldering iron should be used (as below figure). It should be confirmed in advance the characteristics of ALSes will or will not be damaged by repairing.

注意：此一般如使用手工焊接，建议使用小于 25 瓦的电烙铁，烙铁温度必须空置在 300°C 以下，焊接时间需控制在 3 秒钟以内，且每个点击只能焊接一次。

If manual soldering is used, the use of a soldering iron of less than 25W is recommended, and the temperature of the iron must be kept below 300°C, with soldering time within 2 seconds.

使用注意事项 Precautions

感谢您使用惠州市鑫永诚光电科技有限公司的系列环境光传感器产品，为增进您对我公司产品特性的了解，也为了方便您快速掌握产品的基本操作，为尽量减少或避免因人为等因素造成不必要的产品损坏，使其能够更好的为您的生产服务，特针对使用过程中的一些规范使用作相应说明，同时即使是同一规格环境光传感器，在实际应用领域其可靠性与整体系统设计水平、作业方式、使用条件均相关。本使用说明不可能涵盖客户使用过程中可能碰到的所有问题，由此带来的不便，敬请谅解！

Thanks for using relevant ALS products of Shenzhen Newopto Photoelectric Technology Co., Ltd. In order to enhance your understanding of the characteristics of our products, as far as reduce and avoid unnecessary damage of product due to man made factors ,and make the product serve your production better , we provide corresponding operation standard instructions . At the same time, even if you are using the same specifications ALS, its reliability is related to overall system design level ,mode of operation and conditions of use in the practical application field . This Instructions didn' t cover all questions customers may encounter during using, we sincerely apologize for any inconvenience this may cause!

■ 产品声明 Product Declaration

- 使用本产品之前，请贵司务必预先进行测试，以便确认是否适合使用目的，产品介绍的用途并不保证不抵触任何专利，有关 ALS 产品的进出口法律责任应由客户担负，请预先查清每个国家或地区的有关规定。产品可能会因性能提升而更改物料和规格参数，恕不另行通知。

In order to confirm the product is right for using purpose , pretest is necessary before use . We don' t guarantee the product application introduction don' t contravene any patent. The corresponding import and export legal responsibility should be taken by customers. Please verify relevant provision about the ALS product in each country and district beforehand. We may change material and specifications from time to time in the interest of product development, without prior notification or public announcement.

■ 储存 Storage

- 本产使用密封防潮抗静电袋包装,并附有干燥剂,未开封的产品保存时间 6 个月。

Moisture proof and anti-electrostatic package with moisture absorbent material is used, Packaged products have 6 months to save time.

- 开封前,产品须存放在温度不高于 30°C,湿度不高于 60%RH 的环境中。

Before opening the package, the product should be kept at 30°C or less and humidity less the 60%RH 的环境中.

- 密封防静电袋内的湿度卡应在打开袋子后立即查看袋内的湿度指示卡来确定,湿度显示小于或等于 30%时,使用前须进行烘烤。

Seal anti-electrostatic bag humidity card should immediately check bag humidity indicator card in the open the bag after, Humidity is less than or equal to 30%, Must be baked before use.

- 开封后,产品必须 24 小时内使用完(建议工作环境温度不高于 30°C,湿度不高于 60%),如未使用完,余料须存放在温度不高于 30°C,湿度不高于 10%的环境中。

After opening the package, the product should be soldered within 24 hours. If not, please store at 30°C or less and humidity less than 10%RH. It is recommended that the product be operated at the workshop condition of 30°C or less and humidity less than 60%RH.

- 对于尚未焊接的 ALS,如果吸湿剂或包装失效,或者产品没有符合以上有效存储条件,烘烤可以起到一定的性能恢复效果. 烘烤条件:65±5°C,持续时间 24H.

If the moisture absorbent material has fade away or the ALSes have exceeded the storage time, baking treatment should be performed based on the following condition : 65±5°C for 24 hours.

■ 静电 Static Electricity

以下操作可降低静电破坏的可能性。

The following procedures may decrease the possibility of ALS damage.

- 将产品和外界之间的摩擦减到最低以避免静电产生。

Minimize friction between the product and surroundings to avoid static buildup.

- 所有的产品设备和测试仪器必须接地。

All production machinery and test instruments must be electrically grounded.

- 操作人员必须配戴静电环。

Operators must wear anti-static bracelets.

- 进入带电设备工作区域时需穿防静电服。

Wear anti-static suit when entering work areas with conductive machinery.

- 所有操作 IC 和 ESD 敏感器件元器件的工作台必须保持低于 150V 的静电保护。

All workstations that handle IC and ESD-sensitive components must maintain an electrostatic potential of 150V or less.

■ 反压保护 Reverse voltage protection

- 通常 ALS 的反向漏电流都会很小,不会影响正常使用. 如果长期遭受超过其所能承受的反向电压冲击时,ALS 会损伤,反向漏电流会迅速变大,引起显示屏零灰度下串光的发生. 在设计中, 要注意控制反向电压, 建议加在 ALS 上的反向电压值不超过 3V。

In generally the reverse current of LED is very small, it can't effect using the component normally, but when it often suffered the reverse voltage which exceed the limits of the component than it will be damaged, the reverse current increases rapidly causing the string light display gray scale so when designing, please pay attention to control the reverse voltage we suggest the reverse voltage less than 3V.

■ 其他事项 Others

- 请勿直接触摸或操作硅胶透镜表面, 这可能会损坏内部的电路, 拿取时用镊子或合适的工具夹在元件的侧边。

Do not directly touch or handle the silicone lens surface. It may damage the internal circuitry. Handle the component along the side surfaces by using forceps or appropriate tools.

- ALS 的环氧树脂封装部分相当脆弱, 请勿用坚硬、尖锐的物体刮、擦封装树脂部分。在用镊子夹取的时候也应当小心注意。

The epoxy resin of encapsulation is fragile,so please avoid scratch or friction over the epoxy resin surface.while handing the product with tweezers,do not hold by the epoxy resin,be careful.

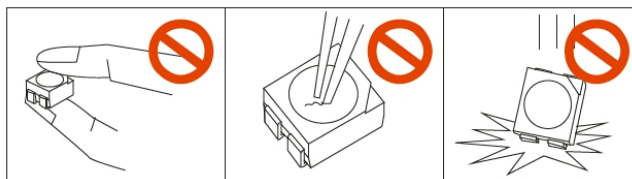

X-ON Electronics

Largest Supplier of Electrical and Electronic Components

Click to view similar products for [Ambient Light Sensors](#) category:

Click to view products by [Newopto Photoelectric](#) manufacturer:

Other Similar products are found below :

[IS31SE5000-UTLS2-TR](#) [SEN0390](#) [ISL29015IROZ-T7](#) [ALS-PT204-6C/L177](#) [LTR-390UV-01](#) [XYC-PT76B30-L1](#) [LTR-381RGB-MT](#) [XYC-PT0603AC-LB1-S](#) [XYC-PT205D-I0](#) [XYC-PT0805BC-L4-D](#) [XYC-PT0805BC-B1-S](#) [XYC-PT21C-L1](#) [XYC-PT1206AC-A8](#) [SLPT1206AC-LB1](#) [ALS-PD70-01C/TR7](#) [GT36528](#) [GT36516](#) [02-LDR1](#) [02-LDR12](#) [02-LDR13](#) [02-LDR14](#) [02-LDR20](#) [02-LDR21](#) [02-LDR22](#) [02-LDR23](#) [0805-PTSM D021](#) [VEML7700-TT](#) [ALS-PT19-315C/L177/TR8](#) [BH1680FVC-TR](#) [EAALSTIC1708A0](#) [AS7261-BLGT](#) [180997-0006](#) [OPT3001IDNPRQ1](#) [OPT3007YMFT](#) [AS7263-BLGT](#) [BH1682FVC-TR](#) [APS3227SP1C-P22](#) [ALS-PDIC144-6C/L378](#) [GL7501F](#) [GL12530F](#) [GL7528](#) [GL4501F](#) [GL4510F](#) [GL5510F](#) [GL5520F](#) [GL12516](#) [GL7520F](#) [GL7530F](#) [GL7549](#) [GL12537](#)