

74AHC1G04-Q100; 74AHCT1G04-Q100

Inverter

Rev. 3 — 11 January 2022

Product data sheet

1. General description

The 74AHC1G04-Q100; 74AHCT1G04-Q100 is a single inverter. Inputs are overvoltage tolerant. This feature allows the use of these devices as translators in mixed voltage environments.

The AHC device has CMOS input switching levels and supply voltage range 2 V to 5.5 V.

The AHCT device has TTL input switching levels and supply voltage range 4.5 V to 5.5 V.

This product has been qualified to the Automotive Electronics Council (AEC) standard Q100 (Grade 1) and is suitable for use in automotive applications.

2. Features and benefits

- Automotive product qualification in accordance with AEC-Q100 (Grade 1)
 - Specified from -40 °C to +85 °C and from -40 °C to +125 °C
- Wide supply voltage range from 2.0 to 5.5 V
- Overvoltage tolerant inputs to 5.5 V
- High noise immunity
- CMOS low power dissipation
- Latch-up performance exceeds 100 mA per JESD 78 Class II Level A
- Symmetrical output impedance
- Balanced propagation delays
- Input levels:
 - For 74AHC1G04-Q100: CMOS level
 - For 74AHCT1G04-Q100: TTL level
- ESD protection:
 - MIL-STD-883, method 3015 exceeds 2000 V
 - HBM JESD22-A114F exceeds 2000 V
 - MM JESD22-A115-A exceeds 200 V (C = 200 pf, R = 0 Ω)

3. Ordering information

Table 1. Ordering information

| Type number | Package | | | |
|-------------------|-------------------|--------|---|----------|
| | Temperature range | Name | Description | Version |
| 74AHC1G04GW-Q100 | -40 °C to +125 °C | TSSOP5 | plastic thin shrink small outline package; 5 leads; body width 1.25 mm | SOT353-1 |
| 74AHCT1G04GW-Q100 | | | | |
| 74AHC1G04GV-Q100 | -40 °C to +125 °C | SC-74A | plastic surface-mounted package; 5 leads | SOT753 |
| 74AHCT1G04GV-Q100 | | | | |

4. Marking

Table 2. Marking codes

| Type number | Marking [1] |
|-------------------|-------------|
| 74AHC1G04GW-Q100 | AC |
| 74AHCT1G04GW-Q100 | CC |
| 74AHC1G04GV-Q100 | A04 |
| 74AHCT1G04GV-Q100 | C04 |

[1] The pin 1 indicator is located on the lower left corner of the device, below the marking code.

5. Functional diagram

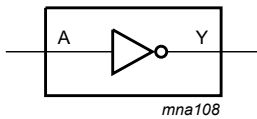

Fig. 1. Logic symbol

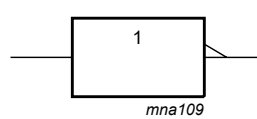

Fig. 2. IEC logic symbol

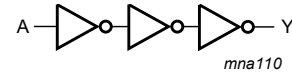

Fig. 3. Logic diagram

6. Pinning information

6.1. Pinning

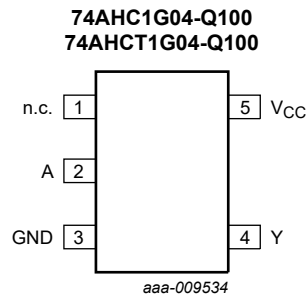

Fig. 4. Pin configuration SOT353-1 (TSSOP5) and SOT753 (SC-74A)

6.2. Pin description

Table 3. Pin description

| Symbol | Pin | Description |
|-----------------|-----|----------------|
| n.c. | 1 | not connected |
| A | 2 | data input |
| GND | 3 | ground (0 V) |
| Y | 4 | data output |
| V _{CC} | 5 | supply voltage |

7. Functional description

Table 4. Function table

H = HIGH voltage level; L = LOW voltage level

| Input | Output |
|-------|--------|
| A | Y |
| L | H |
| H | L |

8. Limiting values

Table 5. Limiting values

In accordance with the Absolute Maximum Rating System (IEC 60134).

| Symbol | Parameter | Conditions | Min | Max | Unit |
|-----------|-------------------------|--|------|------|------|
| V_{CC} | supply voltage | | -0.5 | +7.0 | V |
| V_I | input voltage | | -0.5 | +7.0 | V |
| I_{IK} | input clamping current | $V_I < -0.5$ V | -20 | - | mA |
| I_{OK} | output clamping current | $V_O < -0.5$ V or $V_O > V_{CC} + 0.5$ V [1] | - | ±20 | mA |
| I_O | output current | -0.5 V < V_O < $V_{CC} + 0.5$ V | - | ±25 | mA |
| I_{CC} | supply current | | - | 75 | mA |
| I_{GND} | ground current | | -75 | - | mA |
| T_{stg} | storage temperature | | -65 | +150 | °C |
| P_{tot} | total power dissipation | $T_{amb} = -40$ °C to +125 °C [2] | - | 250 | mW |

[1] The minimum input and output voltage ratings may be exceeded if the input and output current ratings are observed.

[2] For SOT353-1 (TSSOP5) package: P_{tot} derates linearly with 3.3 mW/K above 74 °C.

For SOT753 (SC-74A) package: P_{tot} derates linearly with 3.8 mW/K above 85 °C.

9. Recommended operating conditions

Table 6. Recommended operating conditions

Voltages are referenced to GND (ground = 0 V).

| Symbol | Parameter | Conditions | 74AHC1G04-Q100 | | | 74AHCT1G04-Q100 | | | Unit |
|---------------------|-------------------------------------|--------------------------|----------------|-----|----------|-----------------|-----|----------|------|
| | | | Min | Typ | Max | Min | Typ | Max | |
| V_{CC} | supply voltage | | 2.0 | 5.0 | 5.5 | 4.5 | 5.0 | 5.5 | V |
| V_I | input voltage | | 0 | - | 5.5 | 0 | - | 5.5 | V |
| V_O | output voltage | | 0 | - | V_{CC} | 0 | - | V_{CC} | V |
| T_{amb} | ambient temperature | | -40 | +25 | +125 | -40 | +25 | +125 | °C |
| $\Delta t/\Delta V$ | input transition rise and fall rate | $V_{CC} = 3.3$ V ± 0.3 V | - | - | 100 | - | - | - | ns/V |
| | | $V_{CC} = 5.0$ V ± 0.5 V | - | - | 20 | - | - | 20 | ns/V |

10. Static characteristics

Table 7. Static characteristics

Voltages are referenced to GND (ground = 0 V).

| Symbol | Parameter | Conditions | 25 °C | | | -40 °C to +85 °C | | -40 °C to +125 °C | | Unit |
|------------------------|---------------------------|---|-------|-----|------|------------------|------|-------------------|------|------|
| | | | Min | Typ | Max | Min | Max | Min | Max | |
| 74AHC1G04-Q100 | | | | | | | | | | |
| V _{IH} | HIGH-level input voltage | V _{CC} = 2.0 V | 1.5 | - | - | 1.5 | - | 1.5 | - | V |
| | | V _{CC} = 3.0 V | 2.1 | - | - | 2.1 | - | 2.1 | - | V |
| | | V _{CC} = 5.5 V | 3.85 | - | - | 3.85 | - | 3.85 | - | V |
| V _{IL} | LOW-level input voltage | V _{CC} = 2.0 V | - | - | 0.5 | - | 0.5 | - | 0.5 | V |
| | | V _{CC} = 3.0 V | - | - | 0.9 | - | 0.9 | - | 0.9 | V |
| | | V _{CC} = 5.5 V | - | - | 1.65 | - | 1.65 | - | 1.65 | V |
| V _{OH} | HIGH-level output voltage | V _I = V _{IH} or V _{IL} | | | | | | | | |
| | | I _O = -50 µA; V _{CC} = 2.0 V | 1.9 | 2.0 | - | 1.9 | - | 1.9 | - | V |
| | | I _O = -50 µA; V _{CC} = 3.0 V | 2.9 | 3.0 | - | 2.9 | - | 2.9 | - | V |
| | | I _O = -50 µA; V _{CC} = 4.5 V | 4.4 | 4.5 | - | 4.4 | - | 4.4 | - | V |
| | | I _O = -4.0 mA; V _{CC} = 3.0 V | 2.58 | - | - | 2.48 | - | 2.40 | - | V |
| V _{OL} | LOW-level output voltage | V _I = V _{IH} or V _{IL} | | | | | | | | |
| | | I _O = 50 µA; V _{CC} = 2.0 V | - | 0 | 0.1 | - | 0.1 | - | 0.1 | V |
| | | I _O = 50 µA; V _{CC} = 3.0 V | - | 0 | 0.1 | - | 0.1 | - | 0.1 | V |
| | | I _O = 50 µA; V _{CC} = 4.5 V | - | 0 | 0.1 | - | 0.1 | - | 0.1 | V |
| | | I _O = 4.0 mA; V _{CC} = 3.0 V | - | - | 0.36 | - | 0.44 | - | 0.55 | V |
| | | I _O = 8.0 mA; V _{CC} = 4.5 V | - | - | 0.36 | - | 0.44 | - | 0.55 | V |
| I _I | input leakage current | V _I = 5.5 V or GND; V _{CC} = 0 V to 5.5 V | - | - | 0.1 | - | 1.0 | - | 2.0 | µA |
| I _{CC} | supply current | V _I = V _{CC} or GND; I _O = 0 A; V _{CC} = 5.5 V | - | - | 1.0 | - | 10 | - | 40 | µA |
| C _I | input capacitance | | - | 1.5 | 10 | - | 10 | - | 10 | pF |
| 74AHCT1G04-Q100 | | | | | | | | | | |
| V _{IH} | HIGH-level input voltage | V _{CC} = 4.5 V to 5.5 V | 2.0 | - | - | 2.0 | - | 2.0 | - | V |
| V _{IL} | LOW-level input voltage | V _{CC} = 4.5 V to 5.5 V | - | - | 0.8 | - | 0.8 | - | 0.8 | V |
| V _{OH} | HIGH-level output voltage | V _I = V _{IH} or V _{IL} ; V _{CC} = 4.5 V | | | | | | | | |
| | | I _O = -50 µA | 4.4 | 4.5 | - | 4.4 | - | 4.4 | - | V |
| | | I _O = -8.0 mA | 3.94 | - | - | 3.8 | - | 3.70 | - | V |
| V _{OL} | LOW-level output voltage | V _I = V _{IH} or V _{IL} ; V _{CC} = 4.5 V | | | | | | | | |
| | | I _O = 50 µA | - | 0 | 0.1 | - | 0.1 | - | 0.1 | V |
| | | I _O = 8.0 mA | - | - | 0.36 | - | 0.44 | - | 0.55 | V |

| Symbol | Parameter | Conditions | 25 °C | | | -40 °C to +85 °C | | -40 °C to +125 °C | | Unit |
|------------------|---------------------------|--|-------|-----|------|------------------|-----|-------------------|-----|------|
| | | | Min | Typ | Max | Min | Max | Min | Max | |
| I _I | input leakage current | V _I = 5.5 V or GND; V _{CC} = 0 V to 5.5 V | - | - | 0.1 | - | 1.0 | - | 2.0 | μA |
| I _{CC} | supply current | V _I = V _{CC} or GND; I _O = 0 A; V _{CC} = 5.5 V | - | - | 1.0 | - | 10 | - | 40 | μA |
| ΔI _{CC} | additional supply current | per input pin; V _I = 3.4 V; other inputs at V _{CC} or GND; I _O = 0 A; V _{CC} = 5.5 V | - | - | 1.35 | - | 1.5 | - | 1.5 | mA |
| C _I | input capacitance | | - | 1.5 | 10 | - | 10 | - | 10 | pF |

11. Dynamic characteristics

Table 8. Dynamic characteristics

GND = 0 V; t_r = t_f = ≤ 3.0 ns. For test circuit see Fig. 6.

| Symbol | Parameter | Conditions | 25 °C | | | -40 °C to +85 °C | | -40 °C to +125 °C | | Unit |
|------------------------|-------------------------------|---|-------|-----|------|------------------|-----|-------------------|------|------|
| | | | Min | Typ | Max | Min | Max | Min | Max | |
| 74AHC1G04-Q100 | | | | | | | | | | |
| t _{pd} | propagation delay | A to Y; see Fig. 5 [1] | | | | | | | | |
| | | V _{CC} = 3.0 V to 3.6 V; C _L = 15 pF [2] | - | 4.3 | 7.1 | 1.0 | 8.5 | 1.0 | 11.0 | ns |
| | | V _{CC} = 3.0 V to 3.6 V; C _L = 50 pF [2] | - | 6.1 | 10.6 | 1.0 | 12 | 1.0 | 14.5 | ns |
| | | V _{CC} = 4.5 V to 5.5 V; C _L = 15 pF [3] | - | 3.1 | 5.5 | 1.0 | 6.5 | 1.0 | 7.0 | ns |
| | | V _{CC} = 4.5 V to 5.5 V; C _L = 50 pF [3] | - | 4.5 | 7.5 | 1.0 | 8.5 | 1.0 | 9.5 | ns |
| C _{PD} | power dissipation capacitance | per buffer; C _L = 50 pF; f = 1 MHz; V _I = GND to V _{CC} [4] | - | 15 | - | - | - | - | - | pF |
| 74AHCT1G04-Q100 | | | | | | | | | | |
| t _{pd} | propagation delay | A to Y; see Fig. 5 [1] | | | | | | | | |
| | | V _{CC} = 4.5 V to 5.5 V; C _L = 15 pF [3] | - | 3.4 | 6.7 | 1.0 | 7.5 | 1.0 | 8.5 | ns |
| | | V _{CC} = 4.5 V to 5.5 V; C _L = 50 pF [3] | - | 4.9 | 7.7 | 1.0 | 8.5 | 1.0 | 10.0 | ns |
| C _{PD} | power dissipation capacitance | per buffer; C _L = 50 pF; f = 1 MHz; V _I = GND to V _{CC} [4] | - | 16 | - | - | - | - | - | pF |

[1] t_{pd} is the same as t_{PLH} and t_{PHL}.

[2] Typical values are measured at V_{CC} = 3.3 V.

[3] Typical values are measured at V_{CC} = 5.0 V.

[4] C_{PD} is used to determine the dynamic power dissipation P_D (μW).

$P_D = C_{PD} \times V_{CC}^2 \times f_i + \Sigma (C_L \times V_{CC}^2 \times f_o)$ where:

f_i = input frequency in MHz; f_o = output frequency in MHz;

C_L = output load capacitance in pF;

V_{CC} = supply voltage in Volts;

N = total load switching outputs;

$\Sigma(C_L \times V_{CC}^2 \times f_o)$ = sum of outputs.

11.1. Waveforms and test circuit

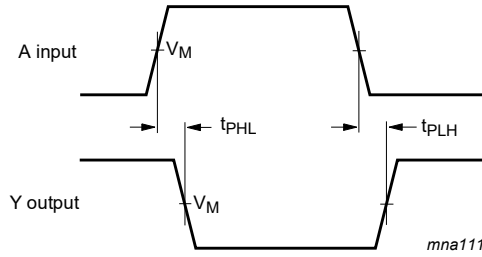

Measurement points are given in [Table 9](#).

Fig. 5. Input (A) to output (Y) propagation delays

Table 9. Measurement point

| Type | Input | Input | Output |
|-----------------|-----------------|---------------------|---------------------|
| | V_I | V_M | V_M |
| 74AHC1G04-Q100 | GND to V_{CC} | $0.5 \times V_{CC}$ | $0.5 \times V_{CC}$ |
| 74AHCT1G04-Q100 | GND to 3.0 V | 1.5 V | $0.5 \times V_{CC}$ |

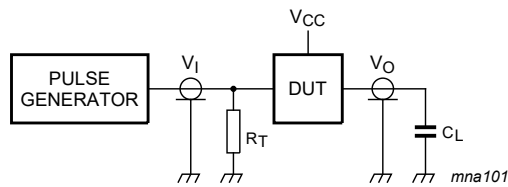

Test data is given in [Table 8](#). Definitions for test circuit:

C_L = Load capacitance including jig and probe capacitance.

R_T = Termination resistance should be equal to output impedance Z_o of the pulse generator.

Fig. 6. Test circuit for measuring switching times

12. Package outline

TSSOP5: plastic thin shrink small outline package; 5 leads; body width 1.25 mm

SOT353-1

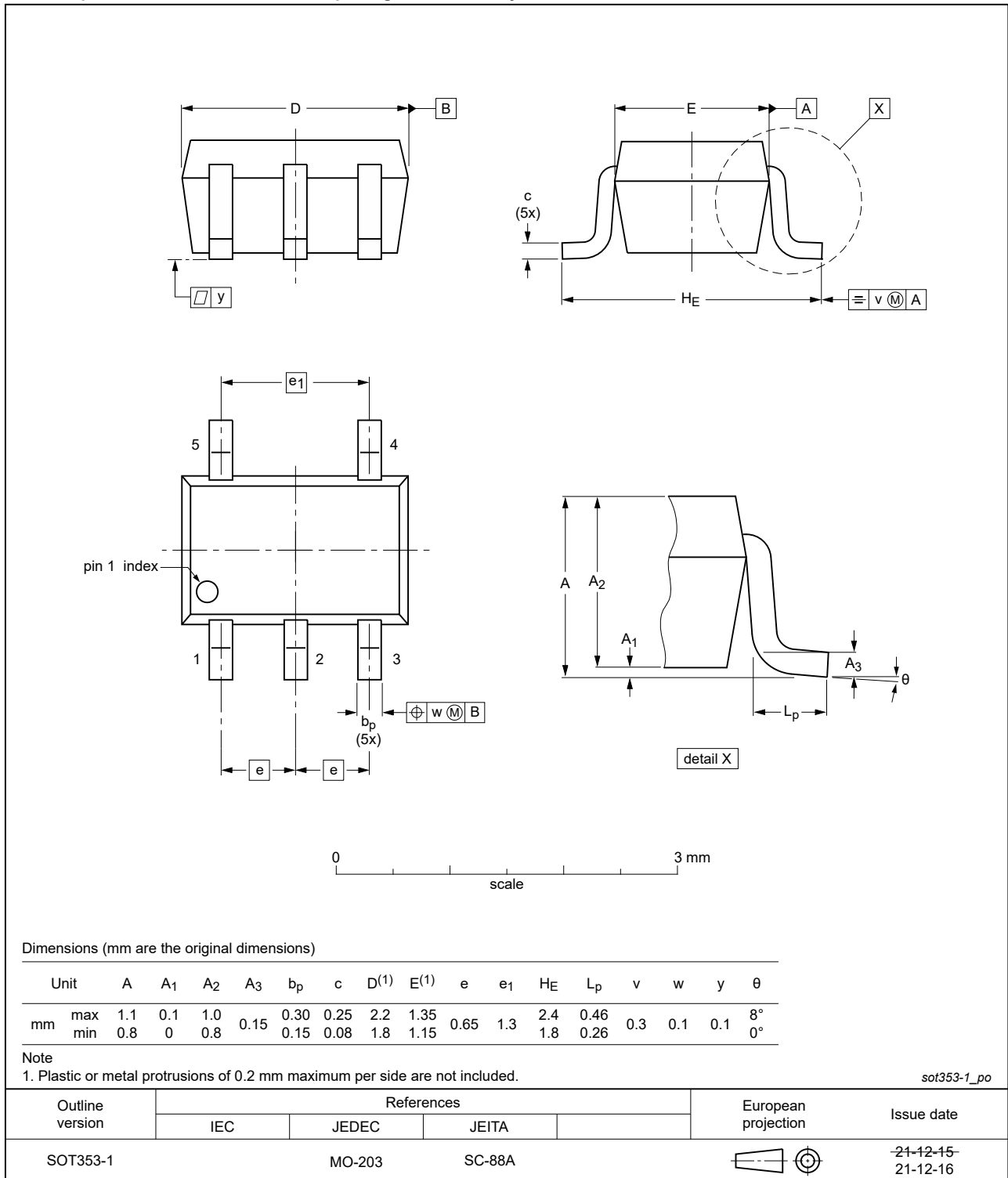

Fig. 7. Package outline SOT353-1 (TSSOP5)

Plastic surface-mounted package; 5 leads

SOT753

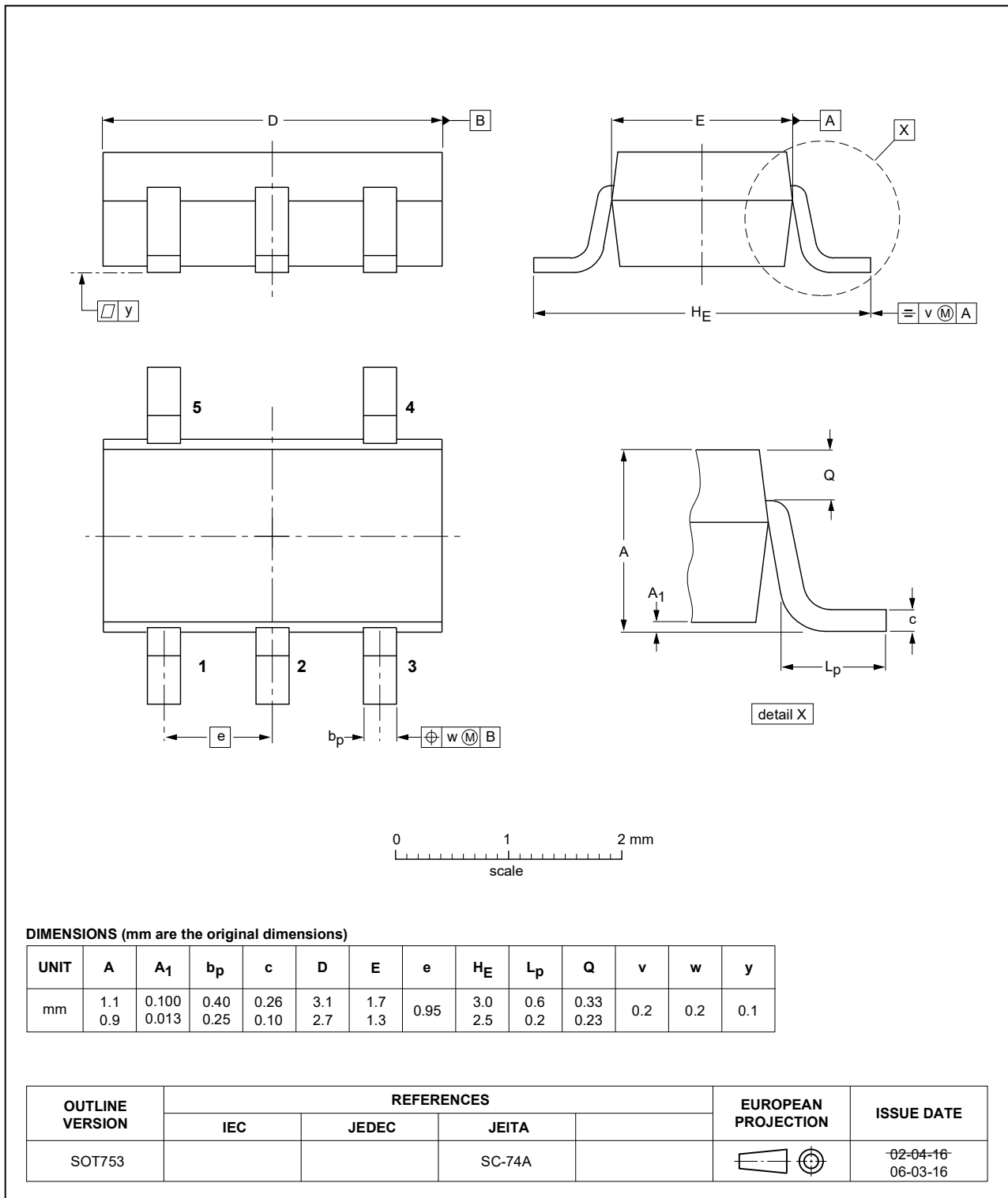

Fig. 8. Package outline SOT753 (SC-74A)

13. Abbreviations

Table 10. Abbreviations

| Acronym | Description |
|---------|---|
| CMOS | Complementary Metal-Oxide Semiconductor |
| DUT | Device Under Test |
| ESD | ElectroStatic Discharge |
| HBM | Human Body Model |
| MIL | Military |
| MM | Machine Model |
| TTL | Transistor-Transistor Logic |

14. Revision history

Table 11. Revision history

| Document ID | Release date | Data sheet status | Change notice | Supersedes |
|-------------------------|---|--------------------|---------------|-------------------------|
| 74AHC_AHCT1G04_Q100 v.3 | 20220111 | Product data sheet | - | 74AHC_AHCT1G04_Q100 v.2 |
| Modifications: | <ul style="list-style-type: none"> Section 1 and Section 2 updated. Fig. 7: Package outline drawing SOT353-1 (TSSOP5) has changed. | | | |
| 74AHC_AHCT1G04_Q100 v.2 | 20190924 | Product data sheet | - | 74AHC_AHCT1G04_Q100 v.1 |
| Modifications: | <ul style="list-style-type: none"> The format of this data sheet has been redesigned to comply with the identity guidelines of Nexperia. Legal texts have been adapted to the new company name where appropriate. Table 5: Derating values for P_{tot} total power dissipation have been updated. | | | |
| 74AHC_AHCT1G04_Q100 v.1 | 20131120 | Product data sheet | - | - |

15. Legal information

Data sheet status

| Document status [1][2] | Product status [3] | Definition |
|--------------------------------|--------------------|---|
| Objective [short] data sheet | Development | This document contains data from the objective specification for product development. |
| Preliminary [short] data sheet | Qualification | This document contains data from the preliminary specification. |
| Product [short] data sheet | Production | This document contains the product specification. |

- [1] Please consult the most recently issued document before initiating or completing a design.
- [2] The term 'short data sheet' is explained in section "Definitions".
- [3] The product status of device(s) described in this document may have changed since this document was published and may differ in case of multiple devices. The latest product status information is available on the internet at <https://www.nexperia.com>.

Definitions

Draft — The document is a draft version only. The content is still under internal review and subject to formal approval, which may result in modifications or additions. Nexperia does not give any representations or warranties as to the accuracy or completeness of information included herein and shall have no liability for the consequences of use of such information.

Short data sheet — A short data sheet is an extract from a full data sheet with the same product type number(s) and title. A short data sheet is intended for quick reference only and should not be relied upon to contain detailed and full information. For detailed and full information see the relevant full data sheet, which is available on request via the local Nexperia sales office. In case of any inconsistency or conflict with the short data sheet, the full data sheet shall prevail.

Product specification — The information and data provided in a Product data sheet shall define the specification of the product as agreed between Nexperia and its customer, unless Nexperia and customer have explicitly agreed otherwise in writing. In no event however, shall an agreement be valid in which the Nexperia product is deemed to offer functions and qualities beyond those described in the Product data sheet.

Disclaimers

Limited warranty and liability — Information in this document is believed to be accurate and reliable. However, Nexperia does not give any representations or warranties, expressed or implied, as to the accuracy or completeness of such information and shall have no liability for the consequences of use of such information. Nexperia takes no responsibility for the content in this document if provided by an information source outside of Nexperia.

In no event shall Nexperia be liable for any indirect, incidental, punitive, special or consequential damages (including - without limitation - lost profits, lost savings, business interruption, costs related to the removal or replacement of any products or rework charges) whether or not such damages are based on tort (including negligence), warranty, breach of contract or any other legal theory.

Notwithstanding any damages that customer might incur for any reason whatsoever, Nexperia's aggregate and cumulative liability towards customer for the products described herein shall be limited in accordance with the Terms and conditions of commercial sale of Nexperia.

Right to make changes — Nexperia reserves the right to make changes to information published in this document, including without limitation specifications and product descriptions, at any time and without notice. This document supersedes and replaces all information supplied prior to the publication hereof.

Suitability for use in automotive applications — This Nexperia product has been qualified for use in automotive applications. Unless otherwise agreed in writing, the product is not designed, authorized or warranted to be suitable for use in life support, life-critical or safety-critical systems or

equipment, nor in applications where failure or malfunction of an Nexperia product can reasonably be expected to result in personal injury, death or severe property or environmental damage. Nexperia and its suppliers accept no liability for inclusion and/or use of Nexperia products in such equipment or applications and therefore such inclusion and/or use is at the customer's own risk.

Quick reference data — The Quick reference data is an extract of the product data given in the Limiting values and Characteristics sections of this document, and as such is not complete, exhaustive or legally binding.

Applications — Applications that are described herein for any of these products are for illustrative purposes only. Nexperia makes no representation or warranty that such applications will be suitable for the specified use without further testing or modification.

Customers are responsible for the design and operation of their applications and products using Nexperia products, and Nexperia accepts no liability for any assistance with applications or customer product design. It is customer's sole responsibility to determine whether the Nexperia product is suitable and fit for the customer's applications and products planned, as well as for the planned application and use of customer's third party customer(s). Customers should provide appropriate design and operating safeguards to minimize the risks associated with their applications and products.

Nexperia does not accept any liability related to any default, damage, costs or problem which is based on any weakness or default in the customer's applications or products, or the application or use by customer's third party customer(s). Customer is responsible for doing all necessary testing for the customer's applications and products using Nexperia products in order to avoid a default of the applications and the products or of the application or use by customer's third party customer(s). Nexperia does not accept any liability in this respect.

Limiting values — Stress above one or more limiting values (as defined in the Absolute Maximum Ratings System of IEC 60134) will cause permanent damage to the device. Limiting values are stress ratings only and (proper) operation of the device at these or any other conditions above those given in the Recommended operating conditions section (if present) or the Characteristics sections of this document is not warranted. Constant or repeated exposure to limiting values will permanently and irreversibly affect the quality and reliability of the device.

Terms and conditions of commercial sale — Nexperia products are sold subject to the general terms and conditions of commercial sale, as published at <http://www.nexperia.com/profile/terms>, unless otherwise agreed in a valid written individual agreement. In case an individual agreement is concluded only the terms and conditions of the respective agreement shall apply. Nexperia hereby expressly objects to applying the customer's general terms and conditions with regard to the purchase of Nexperia products by customer.

No offer to sell or license — Nothing in this document may be interpreted or construed as an offer to sell products that is open for acceptance or the grant, conveyance or implication of any license under any copyrights, patents or other industrial or intellectual property rights.

Export control — This document as well as the item(s) described herein may be subject to export control regulations. Export might require a prior authorization from competent authorities.

Translations — A non-English (translated) version of a document is for reference only. The English version shall prevail in case of any discrepancy between the translated and English versions.

Trademarks

Notice: All referenced brands, product names, service names and trademarks are the property of their respective owners.

Contents

| | |
|--|-----------|
| 1. General description | 1 |
| 2. Features and benefits | 1 |
| 3. Ordering information | 1 |
| 4. Marking | 2 |
| 5. Functional diagram | 2 |
| 6. Pinning information | 2 |
| 6.1. Pinning..... | 2 |
| 6.2. Pin description..... | 2 |
| 7. Functional description | 3 |
| 8. Limiting values | 3 |
| 9. Recommended operating conditions | 3 |
| 10. Static characteristics | 4 |
| 11. Dynamic characteristics | 5 |
| 11.1. Waveforms and test circuit..... | 6 |
| 12. Package outline | 7 |
| 13. Abbreviations | 9 |
| 14. Revision history | 9 |
| 15. Legal information | 10 |

© Nexperia B.V. 2022. All rights reserved

For more information, please visit: <http://www.nexperia.com>

For sales office addresses, please send an email to: salesaddresses@nexperia.com

Date of release: 11 January 2022

X-ON Electronics

Largest Supplier of Electrical and Electronic Components

Click to view similar products for [Inverters](#) category:

Click to view products by [Nexperia](#) manufacturer:

Other Similar products are found below :

[E5-652Z](#) [NL17SGU04P5T5G](#) [NLX2G04BMX1TCG](#) [CD4009UBE](#) [TC4584BFN](#) [022413E](#) [NL17SG14AMUTCG](#) [NLU2G04AMUTCG](#)
[NLU2GU04BMX1TCG](#) [NLU2G04CMX1TCG](#) [NLV17SZ06DFT2G](#) [NLV27WZ04DFT2G](#) [NCV1729SN35T1G](#) [TC74VHC04FK\(EL,K\)](#)
[NLV74HC04ADTR2G](#) [NLU1G04AMUTCG](#) [NLX2G04CMUTCG](#) [NLU1GT14AMUTCG](#) [NLU1G04CMUTCG](#) [NL17SZU04P5T5G](#)
[NL17SG14DFT2G](#) [74LVC06ADTR2G](#) [74LVC04ADR2G](#) [NLV37WZ04USG](#) [NLX3G14FMUTCG](#) [NL17SZ04P5T5G](#)
[NLV27WZU04DFT2G](#) [NLV17SG14DFT2G](#) [74ACT14SC](#) [BU4069UBF-E2](#) [EMPP008Z](#) [NLV14106BDTR2G](#) [NLV74AC14DTR2G](#)
[SN74HCT04DE4](#) [ODE-3-120023-1F12](#) [74VHCT04AM](#) [TC74HC04APF](#) [TC7SH04F,LJ\(CT](#) [CD74HC14M96](#) [TC7W14FK,LF](#)
[74VHC14MTCX](#) [74LCX14MTC](#) [SN74LVC1GU04DBVR](#) [SN74LVC14APWR](#) [NLU1G14BMX1TCG](#) [NLU2G04AMX1TCG](#)
[NLU3G14AMX1TCG](#) [NLVVHC1G04DFT2G](#) [NLX2G04CMX1TCG](#) [NLX3G14AMX1TCG](#)