



# BCV63; BCV63B

NPN general-purpose double transistors

Rev. 4 — 4 August 2010

Product data sheet

## 1. Product profile

### 1.1 General description

NPN general-purpose double transistors in a small SOT143B Surface-Mounted Device (SMD) plastic package.

Table 1. Product overview

Type number	Package		PNP complement
	Nexperia	JEITA	
BCV63	SOT143B	-	-
BCV63B			BCV64B

### 1.2 Features and benefits

- Low current (max. 100 mA)
- Low voltage (max. 30 V and 6 V)
- AEC-Q101 qualified
- Small SMD plastic package

### 1.3 Applications

- General-purpose switching and amplification
- For use in Schmitt trigger applications

### 1.4 Quick reference data

Table 2. Quick reference data

Symbol	Parameter	Conditions	Min	Typ	Max	Unit
<b>Per transistor</b>						
$I_C$	collector current		-	-	100	mA
<b>Transistor TR1</b>						
$V_{CE0}$	collector-emitter voltage	open base	-	-	30	V
$h_{FE}$	DC current gain	$V_{CE} = 5\text{ V}; I_C = 2\text{ mA}$				
			BCV63	110	-	800
			BCV63B	200	-	450

Table 2. Quick reference data ...continued

Symbol	Parameter	Conditions	Min	Typ	Max	Unit
<b>Transistor TR2</b>						
$V_{CE0}$	collector-emitter voltage	open base	-	-	6	V
$h_{FE}$	DC current gain	$V_{CE} = 700 \text{ mV}; I_C = 2 \text{ mA}$ [1]				
	BCV63		110	-	800	
	BCV63B		200	-	450	

[1] Group selection will be done on TR1. Due to matched dies,  $h_{FE}$  values for TR2 are the same as for TR1.

## 2. Pinning information

Table 3. Pinning

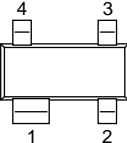
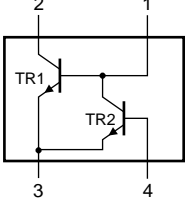
Pin	Description	Simplified outline	Graphic symbol
1	collector TR2 and base TR1		
2	collector TR1		
3	emitter TR1 and TR2		
4	base TR2		

006aab22t

## 3. Ordering information

Table 4. Ordering information

Type number	Package		Version
	Name	Description	
BCV63	-	plastic surface-mounted package; 4 leads	SOT143B
BCV63B			

## 4. Marking

Table 5. Marking codes

Type number	Marking code <sup>[1]</sup>
BCV63	*D5
BCV63B	*D6

[1] \* = -: made in Hong Kong  
 \* = p: made in Hong Kong  
 \* = t: made in Malaysia  
 \* = W: made in China

## 5. Limiting values

**Table 6. Limiting values**

*In accordance with the Absolute Maximum Rating System (IEC 60134).*

Symbol	Parameter	Conditions	Min	Max	Unit
<b>Per transistor</b>					
$V_{EBO}$	emitter-base voltage	open collector	-	6	V
$I_C$	collector current		-	100	mA
$I_{CM}$	peak collector current		-	200	mA
$I_B$	base current		-	100	mA
<b>Transistor TR1</b>					
$V_{CBO}$	collector-base voltage	open emitter	-	30	V
$V_{CEO}$	collector-emitter voltage	open base	-	30	V
<b>Transistor TR2</b>					
$V_{CBO}$	collector-base voltage	open emitter	-	6	V
$V_{CEO}$	collector-emitter voltage	open base	-	6	V
<b>Per device</b>					
$P_{tot}$	total power dissipation	$T_{amb} \leq 25\text{ °C}$	[1] -	250	mW
$T_j$	junction temperature		-	150	°C
$T_{amb}$	ambient temperature		-65	+150	°C
$T_{stg}$	storage temperature		-65	+150	°C

[1] Device mounted on an FR4 Printed-Circuit Board (PCB).

## 6. Thermal characteristics

**Table 7. Thermal characteristics**

Symbol	Parameter	Conditions	Min	Typ	Max	Unit
$R_{th(j-a)}$	thermal resistance from junction to ambient	in free air	[1] -	-	500	K/W

[1] Device mounted on an FR4 PCB.

## 7. Characteristics

**Table 8. Characteristics**

$T_j = 25\text{ °C}$  unless otherwise specified.

Symbol	Parameter	Conditions	Min	Typ	Max	Unit	
<b>Per transistor</b>							
$I_{CBO}$	collector-base cut-off current	$V_{CB} = 30\text{ V}; I_E = 0\text{ A}$	-	-	15	nA	
		$V_{CB} = 30\text{ V}; I_E = 0\text{ A}; T_j = 150\text{ °C}$	-	-	5	$\mu\text{A}$	
$V_{CEsat}$	collector-emitter saturation voltage	$I_C = 10\text{ mA}; I_B = 0.5\text{ mA}$	-	75	300	mV	
$V_{BEsat}$	base-emitter saturation voltage	$I_C = 10\text{ mA}; I_B = 0.5\text{ mA}$	[2]	700	-	mV	
<b>Transistor TR1</b>							
$h_{FE}$	DC current gain	$V_{CE} = 5\text{ V}; I_C = 2\text{ mA}$					
			BCV63	110	-	800	
			BCV63B	200	-	450	
$V_{CEsat}$	collector-emitter saturation voltage	$I_C = 100\text{ mA}; I_B = 5\text{ mA}$	-	250	650	mV	
$V_{BEsat}$	base-emitter saturation voltage	$I_C = 100\text{ mA}; I_B = 5\text{ mA}$	[2]	850	-	mV	
$V_{BE}$	base-emitter voltage	$I_C = 2\text{ mA}; V_{CE} = 5\text{ V}$	[3]	600	650	750	mV
		$I_C = 10\text{ mA}; V_{CE} = 5\text{ V}$	[3]	-	-	820	mV
$f_T$	transition frequency	$V_{CE} = 5\text{ V}; I_C = 10\text{ mA}; f = 100\text{ MHz}$	100	-	-	MHz	
$C_c$	collector capacitance	$V_{CB} = 10\text{ V}; I_E = i_e = 0\text{ A}; f = 1\text{ MHz}$	-	4	-	pF	
<b>Transistor TR2</b>							
$h_{FE}$	DC current gain	$V_{CE} = 700\text{ mV}; I_C = 2\text{ mA}$					
			BCV63	110	-	800	
			BCV63B	200	-	450	
$V_{CEsat}$	collector-emitter saturation voltage	$I_C = 100\text{ mA}; I_B = 5\text{ mA}$	-	250	-	mV	
$V_{BE}$	base-emitter voltage	$I_C = 2\text{ mA}; V_{CE} = 700\text{ mV}$	[3]	700	-	mV	

[1] Group selection will be done on TR1. Due to matched dies,  $h_{FE}$  values for TR2 are the same as for TR1.

[2]  $V_{BEsat}$  decreases by about 1.7 mV/K with increasing temperature.

[3]  $V_{BE}$  decreases by about 2 mV/K with increasing temperature.

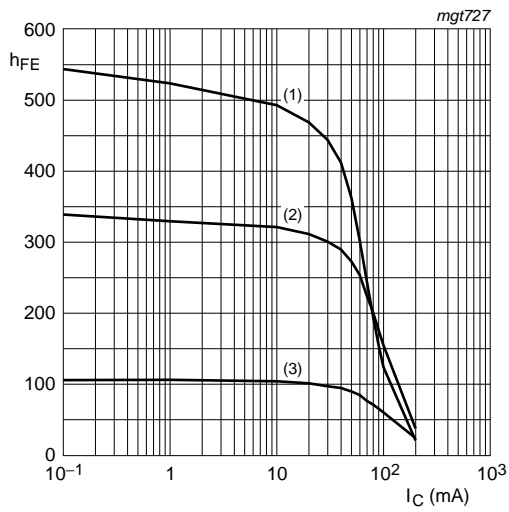

- $V_{CE} = 5\text{ V}$
- (1)  $T_{amb} = 150\text{ °C}$
  - (2)  $T_{amb} = 25\text{ °C}$
  - (3)  $T_{amb} = -55\text{ °C}$

**Fig 1. BCV63B: DC current gain as a function of collector current; typical values**

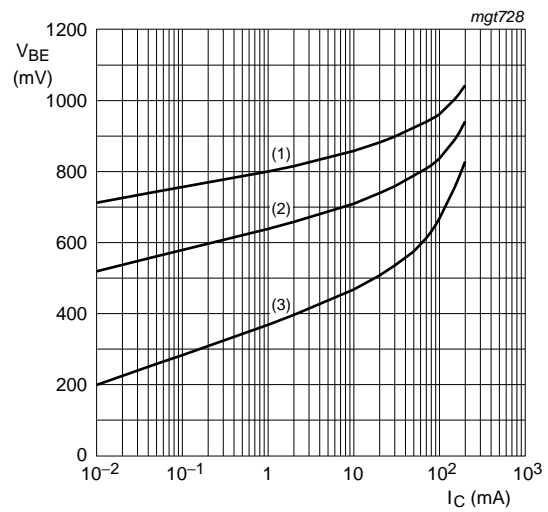

- $V_{CE} = 5\text{ V}$
- (1)  $T_{amb} = -55\text{ °C}$
  - (2)  $T_{amb} = 25\text{ °C}$
  - (3)  $T_{amb} = 150\text{ °C}$

**Fig 2. BCV63B: Base-emitter voltage as a function of collector current; typical values**

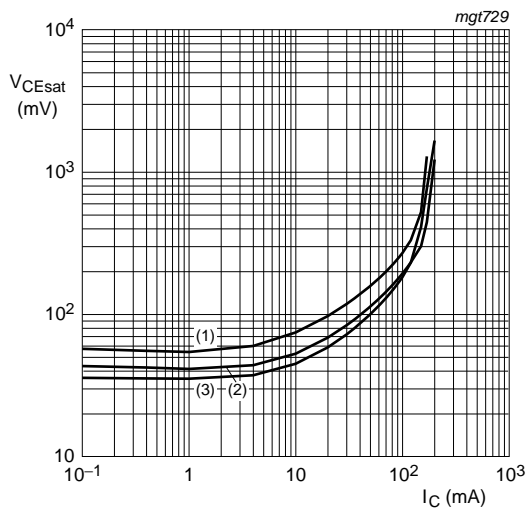

- $I_C/I_B = 20$
- (1)  $T_{amb} = 150\text{ °C}$
  - (2)  $T_{amb} = 25\text{ °C}$
  - (3)  $T_{amb} = -55\text{ °C}$

**Fig 3. BCV63B: Collector-emitter saturation voltage as a function of collector current; typical values**

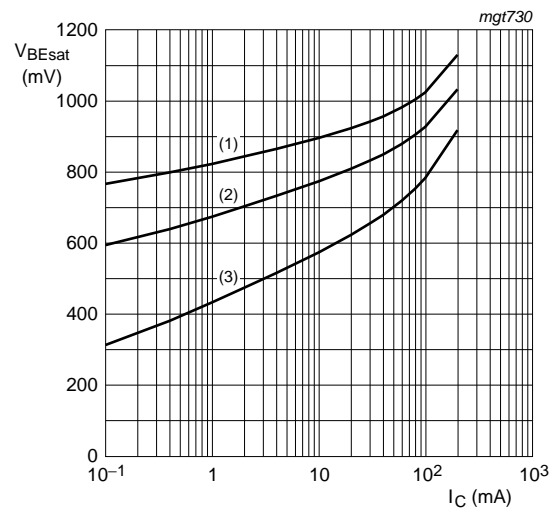

- $I_C/I_B = 10$
- (1)  $T_{amb} = -55\text{ °C}$
  - (2)  $T_{amb} = 25\text{ °C}$
  - (3)  $T_{amb} = 150\text{ °C}$

**Fig 4. BCV63B: Base-emitter saturation voltage as a function of collector current; typical values**

## 8. Application information

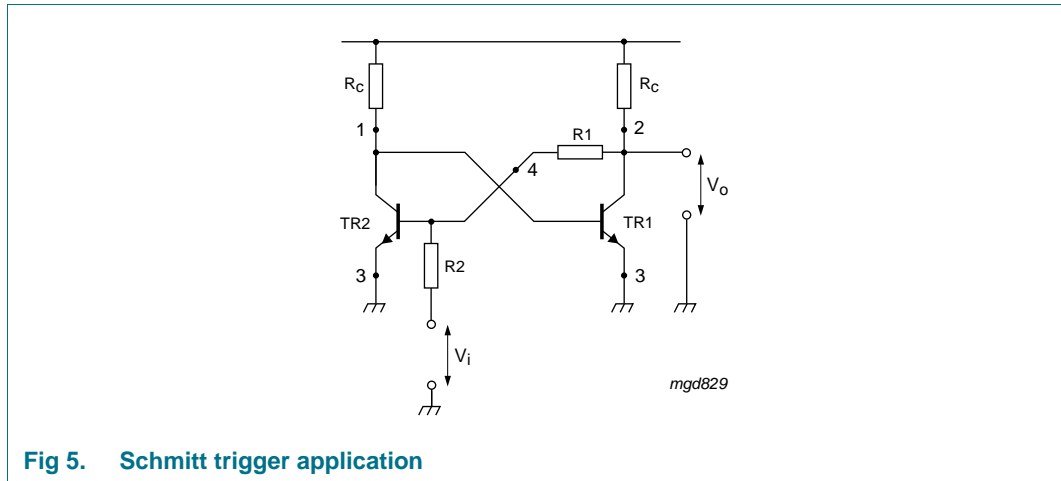

Fig 5. Schmitt trigger application

## 9. Test information

### 9.1 Quality information

This product has been qualified in accordance with the Automotive Electronics Council (AEC) standard *Q101 - Stress test qualification for discrete semiconductors*, and is suitable for use in automotive applications.

## 10. Package outline

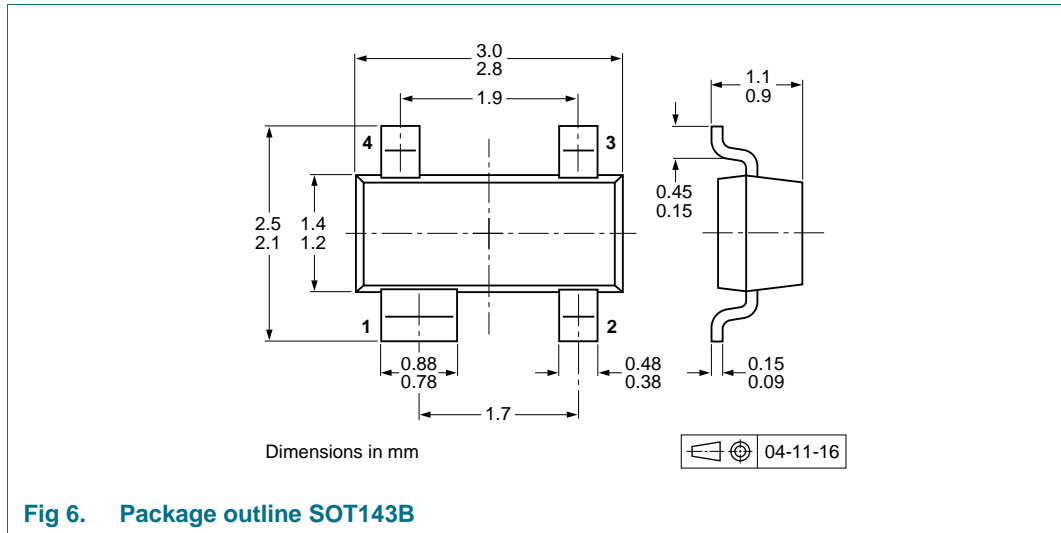

Fig 6. Package outline SOT143B

## 11. Packing information

**Table 9. Packing methods**

The indicated -xxx are the last three digits of the 12NC ordering code.<sup>[1]</sup>

Type number	Package	Description	Packing quantity	
			3000	10000
BCV63	SOT143B	4 mm pitch, 8 mm tape and reel	-215	-235
BCV63B				

[1] For further information and the availability of packing methods, see [Section 14](#).





## 13. Revision history

Table 10. Revision history

Document ID	Release date	Data sheet status	Change notice	Supersedes
BCV63_63B v.4	20100804	Product data sheet	-	BCV63_BCV63B_3
Modifications:	<ul style="list-style-type: none"> <li>• The format of this data sheet has been redesigned to comply with the new identity guidelines of NXP Semiconductors.</li> <li>• Legal texts have been adapted to the new company name where appropriate.</li> <li>• <a href="#">Section 1 "Product profile"</a>: amended</li> <li>• <a href="#">Section 3 "Ordering information"</a>: added</li> <li>• <a href="#">Section 4 "Marking"</a>: updated</li> <li>• <a href="#">Figure 1, 2, 3 and 4</a>: added</li> <li>• <a href="#">Section 8 "Application information"</a>: added</li> <li>• <a href="#">Section 9 "Test information"</a>: added</li> <li>• <a href="#">Figure 6</a>: superseded by minimized package outline drawing</li> <li>• <a href="#">Section 11 "Packing information"</a>: added</li> <li>• <a href="#">Section 12 "Soldering"</a>: added</li> <li>• <a href="#">Section 14 "Legal information"</a>: updated</li> </ul>			
BCV63_BCV63B_3	19990521	Product specification	-	BCV63_CNV_2
BCV63_CNV_2	19970310	Product specification	-	-

## 14. Legal information

### 14.1 Data sheet status

Document status <sup>[1][2]</sup>	Product status <sup>[3]</sup>	Definition
Objective [short] data sheet	Development	This document contains data from the objective specification for product development.
Preliminary [short] data sheet	Qualification	This document contains data from the preliminary specification.
Product [short] data sheet	Production	This document contains the product specification.

[1] Please consult the most recently issued document before initiating or completing a design.

[2] The term 'short data sheet' is explained in section "Definitions".

[3] The product status of device(s) described in this document may have changed since this document was published and may differ in case of multiple devices. The latest product status information is available on the Internet at URL <http://www.nexperia.com>.

### 14.2 Definitions

**Draft** — The document is a draft version only. The content is still under internal review and subject to formal approval, which may result in modifications or additions. Nexperia does not give any representations or warranties as to the accuracy or completeness of information included herein and shall have no liability for the consequences of use of such information.

**Short data sheet** — A short data sheet is an extract from a full data sheet with the same product type number(s) and title. A short data sheet is intended for quick reference only and should not be relied upon to contain detailed and full information. For detailed and full information see the relevant full data sheet, which is available on request via the local Nexperia sales office. In case of any inconsistency or conflict with the short data sheet, the full data sheet shall prevail.

**Product specification** — The information and data provided in a Product data sheet shall define the specification of the product as agreed between Nexperia and its customer, unless Nexperia and customer have explicitly agreed otherwise in writing. In no event however, shall an agreement be valid in which the Nexperia product is deemed to offer functions and qualities beyond those described in the Product data sheet.

### 14.3 Disclaimers

**Limited warranty and liability** — Information in this document is believed to be accurate and reliable. However, Nexperia does not give any representations or warranties, expressed or implied, as to the accuracy or completeness of such information and shall have no liability for the consequences of use of such information.

In no event shall Nexperia be liable for any indirect, incidental, punitive, special or consequential damages (including - without limitation - lost profits, lost savings, business interruption, costs related to the removal or replacement of any products or rework charges) whether or not such damages are based on tort (including negligence), warranty, breach of contract or any other legal theory.

Notwithstanding any damages that customer might incur for any reason whatsoever, Nexperia's aggregate and cumulative liability towards customer for the products described herein shall be limited in accordance with the *Terms and conditions of commercial sale* of Nexperia.

**Right to make changes** — Nexperia reserves the right to make changes to information published in this document, including without limitation specifications and product descriptions, at any time and without notice. This document supersedes and replaces all information supplied prior to the publication hereof.

**Suitability for use** — Nexperia products are not designed, authorized or warranted to be suitable for use in life support, life-critical or safety-critical systems or equipment, nor in applications where failure or

malfunction of a Nexperia product can reasonably be expected to result in personal injury, death or severe property or environmental damage. Nexperia accepts no liability for inclusion and/or use of Nexperia products in such equipment or applications and therefore such inclusion and/or use is at the customer's own risk.

**Applications** — Applications that are described herein for any of these products are for illustrative purposes only. Nexperia makes no representation or warranty that such applications will be suitable for the specified use without further testing or modification.

Customers are responsible for the design and operation of their applications and products using Nexperia products, and Nexperia accepts no liability for any assistance with applications or customer product design. It is customer's sole responsibility to determine whether the Nexperia product is suitable and fit for the customer's applications and products planned, as well as for the planned application and use of customer's third party customer(s). Customers should provide appropriate design and operating safeguards to minimize the risks associated with their applications and products.

Nexperia does not accept any liability related to any default, damage, costs or problem which is based on any weakness or default in the customer's applications or products, or the application or use by customer's third party customer(s). Customer is responsible for doing all necessary testing for the customer's applications and products using Nexperia products in order to avoid a default of the applications and the products or of the application or use by customer's third party customer(s). Nexperia does not accept any liability in this respect.

**Limiting values** — Stress above one or more limiting values (as defined in the Absolute Maximum Ratings System of IEC 60134) will cause permanent damage to the device. Limiting values are stress ratings only and (proper) operation of the device at these or any other conditions above those given in the Recommended operating conditions section (if present) or the Characteristics sections of this document is not warranted. Constant or repeated exposure to limiting values will permanently and irreversibly affect the quality and reliability of the device.

**Terms and conditions of commercial sale** — Nexperia products are sold subject to the general terms and conditions of commercial sale, as published at <http://www.nexperia.com/profile/terms>, unless otherwise agreed in a valid written individual agreement. In case an individual agreement is concluded only the terms and conditions of the respective agreement shall apply. Nexperia hereby expressly objects to applying the customer's general terms and conditions with regard to the purchase of Nexperia products by customer.

**No offer to sell or license** — Nothing in this document may be interpreted or construed as an offer to sell products that is open for acceptance or the grant, conveyance or implication of any license under any copyrights, patents or other industrial or intellectual property rights.

**Export control** — This document as well as the item(s) described herein may be subject to export control regulations. Export might require a prior authorization from national authorities.

**Quick reference data** — The Quick reference data is an extract of the product data given in the Limiting values and Characteristics sections of this document, and as such is not complete, exhaustive or legally binding.

## 14.4 Trademarks

Notice: All referenced brands, product names, service names and trademarks are the property of their respective owners.

## 15. Contact information

---

For more information, please visit: <http://www.nexperia.com>

For sales office addresses, please send an email to: [salesaddresses@nexperia.com](mailto:salesaddresses@nexperia.com)

## 16. Contents

---

<b>1</b>	<b>Product profile</b> . . . . .	<b>1</b>
1.1	General description . . . . .	1
1.2	Features and benefits . . . . .	1
1.3	Applications . . . . .	1
1.4	Quick reference data . . . . .	1
<b>2</b>	<b>Pinning information</b> . . . . .	<b>2</b>
<b>3</b>	<b>Ordering information</b> . . . . .	<b>2</b>
<b>4</b>	<b>Marking</b> . . . . .	<b>2</b>
<b>5</b>	<b>Limiting values</b> . . . . .	<b>3</b>
<b>6</b>	<b>Thermal characteristics</b> . . . . .	<b>3</b>
<b>7</b>	<b>Characteristics</b> . . . . .	<b>4</b>
<b>8</b>	<b>Application information</b> . . . . .	<b>6</b>
<b>9</b>	<b>Test information</b> . . . . .	<b>6</b>
9.1	Quality information . . . . .	6
<b>10</b>	<b>Package outline</b> . . . . .	<b>7</b>
<b>11</b>	<b>Packing information</b> . . . . .	<b>7</b>
<b>12</b>	<b>Soldering</b> . . . . .	<b>8</b>
<b>13</b>	<b>Revision history</b> . . . . .	<b>9</b>
<b>14</b>	<b>Legal information</b> . . . . .	<b>10</b>
14.1	Data sheet status . . . . .	10
14.2	Definitions . . . . .	10
14.3	Disclaimers . . . . .	10
14.4	Trademarks . . . . .	11
<b>15</b>	<b>Contact information</b> . . . . .	<b>11</b>
<b>16</b>	<b>Contents</b> . . . . .	<b>12</b>

## X-ON Electronics

Largest Supplier of Electrical and Electronic Components

*Click to view similar products for [Bipolar Transistors - BJT category](#):*

*Click to view products by [Nexperia manufacturer](#):*

Other Similar products are found below :

[619691C](#) [MCH4017-TL-H](#) [BC546/116](#) [BC557/116](#) [BSW67A](#) [NTE158](#) [NTE187A](#) [NTE195A](#) [NTE2302](#) [NTE2330](#) [NTE63](#) [C4460](#)  
[2SA1419T-TD-H](#) [2SA1721-O\(TE85L,F\)](#) [2SA2126-E](#) [2SB1204S-TL-E](#) [2SC5488A-TL-H](#) [2SD2150T100R](#) [SP000011176](#) [FMMTA92QTA](#)  
[2N2369ADCSM](#) [2N5769](#) [2SC2412KT146S](#) [2SC5490A-TL-H](#) [2SD1816S-TL-E](#) [2SD1816T-TL-E](#) [CMXT2207 TR](#) [CPH6501-TL-E](#)  
[MCH4021-TL-E](#) [US6T6TR](#) [NJL0281DG](#) [732314D](#) [CMXT3906 TR](#) [CPH3121-TL-E](#) [CPH6021-TL-H](#) [873787E](#) [IMZ2AT108](#) [UMX21NTR](#)  
[MCH6102-TL-E](#) [NJL0302DG](#) [2N3583](#) [2SA1434-TB-E](#) [2SC3143-4-TB-E](#) [2SD1621S-TD-E](#) [NTE103](#) [30A02MH-TL-E](#) [NSV40301MZ4T1G](#)  
[NTE101](#) [NTE13](#) [NTE15](#)