

# HEF4043B

## Quad R/S latch with 3-state outputs

Rev. 13 — 8 December 2021

Product data sheet

### 1. General description

The HEF4043B is a quad R/S latch with 3-state outputs and common output enable input (OE). Each latch has set (nS), and reset (nR) inputs and a 3-state output (nQ). When OE is LOW, the latch outputs are in the high impedance OFF-state. OE does not affect the state of the latch. Inputs include clamp diodes. This enables the use of current limiting resistors to interface inputs to voltages in excess of  $V_{DD}$ .

### 2. Features and benefits

- Wide supply voltage range from 3.0 to 15.0 V
- CMOS low power dissipation
- High noise immunity
- Fully static operation
- 5 V, 10 V, and 15 V parametric ratings
- Standardized symmetrical output characteristics
- Complies with JEDEC standard JESD 13-B
- ESD protection:
  - HBM JESD22-A114F exceeds 2000 V
  - MM JESD22-A115-A exceeds 200 V (C = 200 pF, R = 0  $\Omega$ )
- Specified from -40 °C to +85 °C

### 3. Applications

- Four-bit storage with output enable

### 4. Ordering information

Table 1. Ordering information

Type number	Package			
	Temperature range	Name	Description	Version
HEF4043BT	-40 °C to +85 °C	SO16	plastic small outline package; 16 leads; body width 3.9 mm	SOT109-1

## 5. Functional diagram

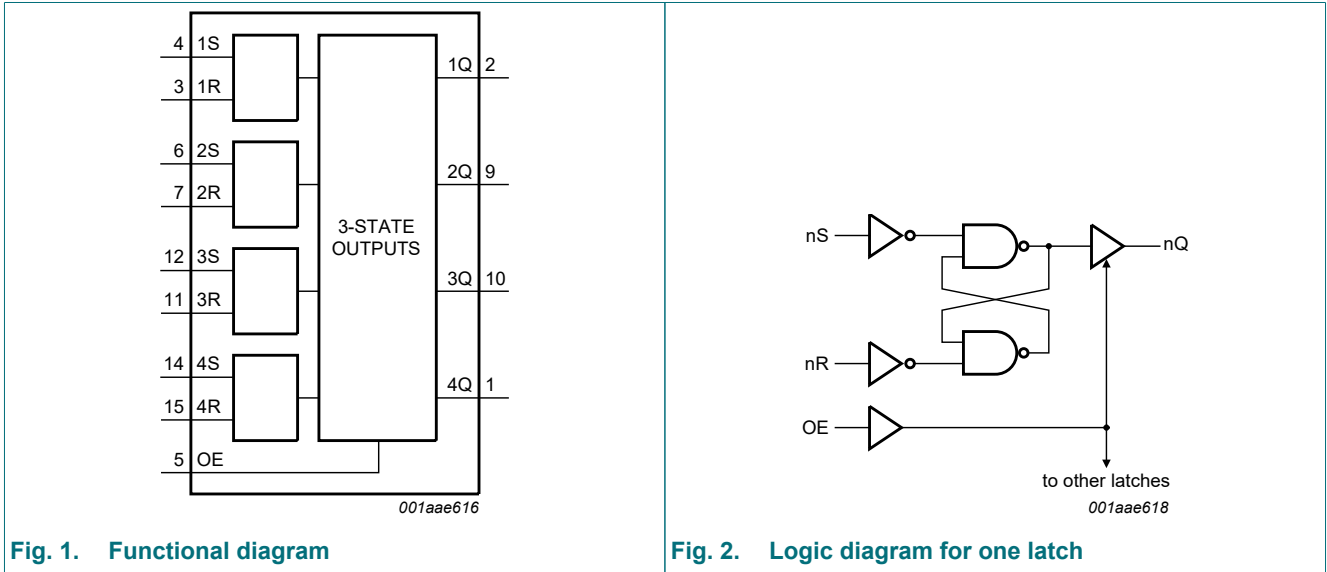

Fig. 1. Functional diagram

Fig. 2. Logic diagram for one latch

## 6. Pinning information

### 6.1. Pinning

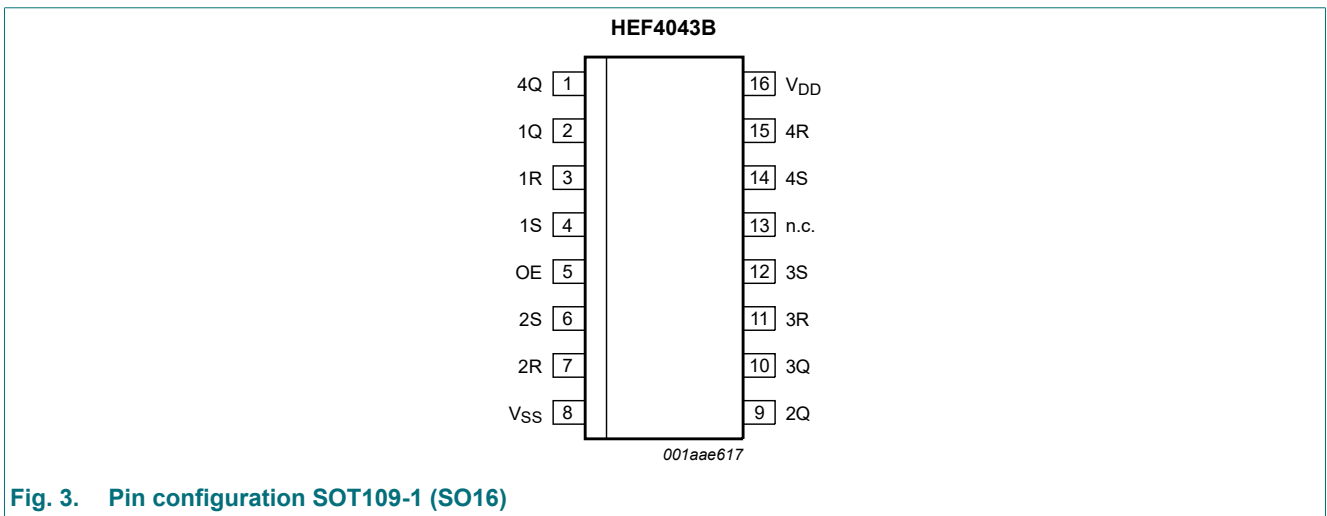

Fig. 3. Pin configuration SOT109-1 (SO16)

## 6.2. Pin description

Table 2. Pin description

Symbol	Pin	Description
1Q, 2Q, 3Q, 4Q	2, 9, 10, 1	3-state buffered latch output
1R, 2R, 3R, 4R	3, 7, 11, 15	reset input (active HIGH)
1S, 2S, 3S, 4S	4, 6, 12, 14	set input (active HIGH)
OE	5	common output enable input
V <sub>SS</sub>	8	ground supply voltage
n.c.	13	not connected
V <sub>DD</sub>	16	supply voltage

## 7. Functional description

Table 3. Function table

H = HIGH voltage level; L = LOW voltage level; X = don't care; Z = high impedance state.

Inputs			Output
OE	nS	nR	nQ
L	X	X	Z
H	L	H	L
H	H	X	H
H	L	L	latched

## 8. Limiting values

Table 4. Limiting values

In accordance with the Absolute Maximum Rating System (IEC 60134).

Symbol	Parameter	Conditions	Min	Max	Unit
V <sub>DD</sub>	supply voltage		-0.5	+18	V
I <sub>IK</sub>	input clamping current	V <sub>I</sub> < -0.5 V or V <sub>I</sub> > V <sub>DD</sub> + 0.5 V	-	±10	mA
V <sub>I</sub>	input voltage		-0.5	V <sub>DD</sub> + 0.5	V
I <sub>OK</sub>	output clamping current	V <sub>O</sub> < -0.5 V or V <sub>O</sub> > V <sub>DD</sub> + 0.5 V	-	±10	mA
I <sub>I/O</sub>	input/output current		-	±10	mA
I <sub>DD</sub>	supply current		-	50	mA
T <sub>stg</sub>	storage temperature		-65	+150	°C
T <sub>amb</sub>	ambient temperature		-40	+85	°C
P <sub>tot</sub>	total power dissipation	T <sub>amb</sub> -40 °C to +85 °C	-	500	mW
P	power dissipation	per output	-	100	mW

## 9. Recommended operating conditions

Table 5. Recommended operating conditions

Symbol	Parameter	Conditions	Min	Typ	Max	Unit
$V_{DD}$	supply voltage		3	-	15	V
$V_I$	input voltage		0	-	$V_{DD}$	V
$T_{amb}$	ambient temperature	in free air	-40	-	+85	°C
$\Delta t/\Delta V$	input transition rise and fall rate	$V_{DD} = 5\text{ V}$	-	-	3.75	$\mu\text{s/V}$
		$V_{DD} = 10\text{ V}$	-	-	0.5	$\mu\text{s/V}$
		$V_{DD} = 15\text{ V}$	-	-	0.08	$\mu\text{s/V}$

## 10. Static characteristics

Table 6. Static characteristics

$V_{SS} = 0\text{ V}$ ;  $V_I = V_{SS}$  or  $V_{DD}$  unless otherwise specified.

Symbol	Parameter	Conditions	$V_{DD}$	$T_{amb} = -40\text{ °C}$		$T_{amb} = +25\text{ °C}$		$T_{amb} = +85\text{ °C}$		Unit
				Min	Max	Min	Max	Min	Max	
$V_{IH}$	HIGH-level input voltage	$ I_O  < 1\ \mu\text{A}$	5 V	3.5	-	3.5	-	3.5	-	V
			10 V	7.0	-	7.0	-	7.0	-	V
			15 V	11.0	-	11.0	-	11.0	-	V
$V_{IL}$	LOW-level input voltage	$ I_O  < 1\ \mu\text{A}$	5 V	-	1.5	-	1.5	-	1.5	V
			10 V	-	3.0	-	3.0	-	3.0	V
			15 V	-	4.0	-	4.0	-	4.0	V
$V_{OH}$	HIGH-level output voltage	$ I_O  < 1\ \mu\text{A}$	5 V	4.95	-	4.95	-	4.95	-	V
			10 V	9.95	-	9.95	-	9.95	-	V
			15 V	14.95	-	14.95	-	14.95	-	V
$V_{OL}$	LOW-level output voltage	$ I_O  < 1\ \mu\text{A}$	5 V	-	0.05	-	0.05	-	0.05	V
			10 V	-	0.05	-	0.05	-	0.05	V
			15 V	-	0.05	-	0.05	-	0.05	V
$I_{OH}$	HIGH-level output current	$V_O = 2.5\text{ V}$	5 V	-	-1.7	-	-1.4	-	-1.1	mA
		$V_O = 4.6\text{ V}$	5 V	-	-0.52	-	-0.44	-	-0.36	mA
		$V_O = 9.5\text{ V}$	10 V	-	-1.3	-	-1.1	-	-0.9	mA
		$V_O = 13.5\text{ V}$	15 V	-	-3.6	-	-3.0	-	-2.4	mA
$I_{OL}$	LOW-level output current	$V_O = 0.4\text{ V}$	5 V	0.52	-	0.44	-	0.36	-	mA
		$V_O = 0.5\text{ V}$	10 V	1.3	-	1.1	-	0.9	-	mA
		$V_O = 1.5\text{ V}$	15 V	3.6	-	3.0	-	2.4	-	mA
$I_I$	input leakage current		15 V	-	$\pm 0.3$	-	$\pm 0.3$	-	$\pm 1.0$	$\mu\text{A}$
$I_{OZ}$	OFF-state output current	nQ output HIGH; returned to $V_{DD}$	15 V	-	1.6	-	1.6	-	12.0	$\mu\text{A}$
		nQ output LOW; returned to $V_{SS}$	15 V	-	1.6	-	1.6	-	12.0	$\mu\text{A}$
$I_{DD}$	supply current	$I_O = 0\text{ A}$	5 V	-	20	-	20	-	150	$\mu\text{A}$
			10 V	-	40	-	40	-	300	$\mu\text{A}$
			15 V	-	80	-	80	-	600	$\mu\text{A}$
$C_I$	input capacitance			-	-	-	7.5	-	-	pF

## 11. Dynamic characteristics

**Table 7. Dynamic characteristics**

$V_{SS} = 0\text{ V}$ ;  $T_{amb} = 25\text{ °C}$  unless otherwise specified; for waveforms and test circuit see [Section 11.1](#).

Symbol	Parameter	Conditions	V <sub>DD</sub>	Extrapolation formula [1]	Min	Typ	Max	Unit
t <sub>PHL</sub>	HIGH to LOW propagation delay	nR → nQ; see <a href="#">Fig. 4</a>	5 V	63 ns + (0.55 ns/pF)C <sub>L</sub>	-	90	180	ns
			10 V	24 ns + (0.23 ns/pF)C <sub>L</sub>	-	35	70	ns
			15 V	17 ns + (0.16 ns/pF)C <sub>L</sub>	-	25	50	ns
t <sub>PLH</sub>	LOW to HIGH propagation delay	nS → nQ; see <a href="#">Fig. 4</a>	5 V	38 ns + (0.55 ns/pF)C <sub>L</sub>	-	65	135	ns
			10 V	14 ns + (0.23 ns/pF)C <sub>L</sub>	-	25	50	ns
			15 V	7 ns + (0.16 ns/pF)C <sub>L</sub>	-	15	35	ns
t <sub>t</sub>	transition time	nQ output; see <a href="#">Fig. 4</a>	5 V [2]	10 ns + (1.00 ns/pF)C <sub>L</sub>	-	60	120	ns
			10 V	9 ns + (0.42 ns/pF)C <sub>L</sub>	-	30	60	ns
			15 V	6 ns + (0.28 ns/pF)C <sub>L</sub>	-	20	40	ns
t <sub>PHZ</sub>	HIGH to OFF-state propagation delay	OE → nQ; see <a href="#">Fig. 5</a>	5 V		-	45	90	ns
			10 V		-	20	35	ns
			15 V		-	10	25	ns
t <sub>PLZ</sub>	LOW to OFF-state propagation delay	OE → nQ; see <a href="#">Fig. 5</a>	5 V		-	50	100	ns
			10 V		-	20	40	ns
			15 V		-	10	25	ns
t <sub>PZH</sub>	OFF-state to HIGH propagation delay	OE → nQ; see <a href="#">Fig. 5</a>	5 V		-	25	50	ns
			10 V		-	15	30	ns
			15 V		-	10	25	ns
t <sub>PZL</sub>	OFF-state to LOW propagation delay	OE → nQ; see <a href="#">Fig. 5</a>	5 V		-	40	80	ns
			10 V		-	20	45	ns
			15 V		-	15	35	ns
t <sub>w</sub>	pulse width	nS input HIGH; minimum width; see <a href="#">Fig. 4</a>	5 V		30	15	-	ns
			10 V		20	10	-	ns
			15 V		16	8	-	ns
		nR input HIGH; minimum width; see <a href="#">Fig. 4</a>	5 V		30	15	-	ns
			10 V		20	10	-	ns
			15 V		16	8	-	ns

[1] The typical values of the propagation delay and transition times are calculated from the extrapolation formulas shown (C<sub>L</sub> in pF).

[2] t<sub>t</sub> is the same as t<sub>THL</sub> and t<sub>TLH</sub>.

**Table 8. Dynamic power dissipation P<sub>D</sub>**

P<sub>D</sub> can be calculated from the formulas shown.  $V_{SS} = 0\text{ V}$ ;  $t_r = t_f \leq 20\text{ ns}$ ;  $T_{amb} = 25\text{ °C}$ .

Symbol	Parameter	V <sub>DD</sub>	Typical formula for P <sub>D</sub> (μW)	where:
P <sub>D</sub>	dynamic power dissipation	5 V	$P_D = 1100 \times f_i + \Sigma(f_o \times C_L) \times V_{DD}^2$	f <sub>i</sub> = input frequency in MHz; f <sub>o</sub> = output frequency in MHz; C <sub>L</sub> = output load capacitance in pF; V <sub>DD</sub> = supply voltage in V; Σ(f <sub>o</sub> × C <sub>L</sub> ) = sum of the outputs.
		10 V	$P_D = 4400 \times f_i + \Sigma(f_o \times C_L) \times V_{DD}^2$	
		15 V	$P_D = 11400 \times f_i + \Sigma(f_o \times C_L) \times V_{DD}^2$	

11.1. Waveforms and test circuit

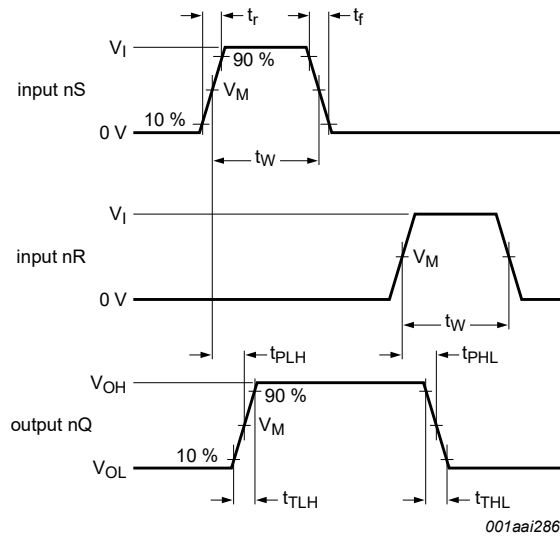

Measurement points are given in [Table 9](#).

Logic levels:  $V_{OL}$  and  $V_{OH}$  are typical output voltage levels that occur with the output load.

**Fig. 4.** Input minimum set (nS) and reset (nR) pulse widths, inputs nS or nR to latch output (nQ) propagation delay and nQ transition time

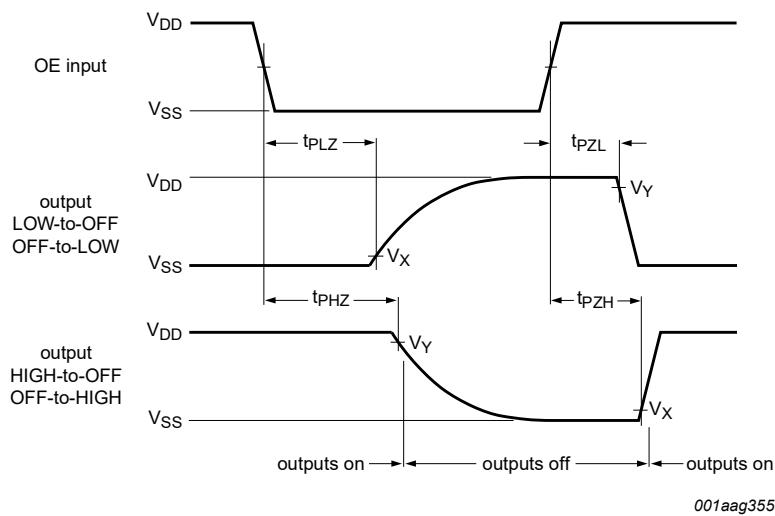

Measurement points are given in [Table 9](#).

**Fig. 5.** Output enable (OE) to latch output (nQ) enable time ( $t_{PZL}$  and  $t_{PZH}$ ) and disable time ( $t_{PLZ}$  and  $t_{PHZ}$ )

**Table 9. Measurement points**

Supply voltage	Input		Output		
$V_{DD}$	$V_i$	$V_M$	$V_M$	$V_X$	$V_Y$
5 V to 15 V	$V_{DD}$ or 0 V	$0.5V_{DD}$	$0.5V_{DD}$	$0.1V_{DD}$	$0.9V_{DD}$

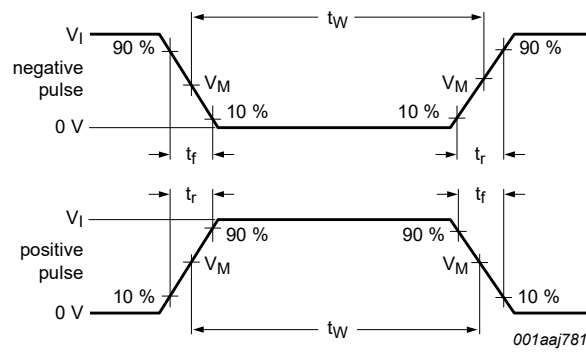

a. Input waveform

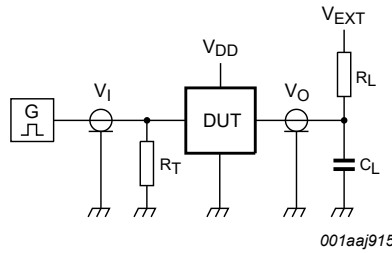

b. Test circuit

Test and measurement data is given in [Table 10](#).

Definitions for test circuit:

$R_L$  = Load resistance;

$C_L$  = Load capacitance including jig and probe capacitance;

$R_T$  = Termination resistance should be equal to output impedance  $Z_o$  of the pulse generator;

$V_{EXT}$  = External voltage for measuring switching times.

**Fig. 6. Test circuit for measuring switching times**

**Table 10. Test data**

Supply voltage	Input		Load		$V_{EXT}$		
$V_{DD}$	$V_I$	$t_r, t_f$	$C_L$	$R_L$	$t_{PLH}, t_{PHL}$	$t_{PLZ}, t_{PZL}$	$t_{PHZ}, t_{PZH}$
5 V to 15 V	$V_{DD}$	$\leq 20$ ns	50 pF	1 k $\Omega$	open	$V_{DD}$	GND

12. Package outline

SO16: plastic small outline package; 16 leads; body width 3.9 mm

SOT109-1

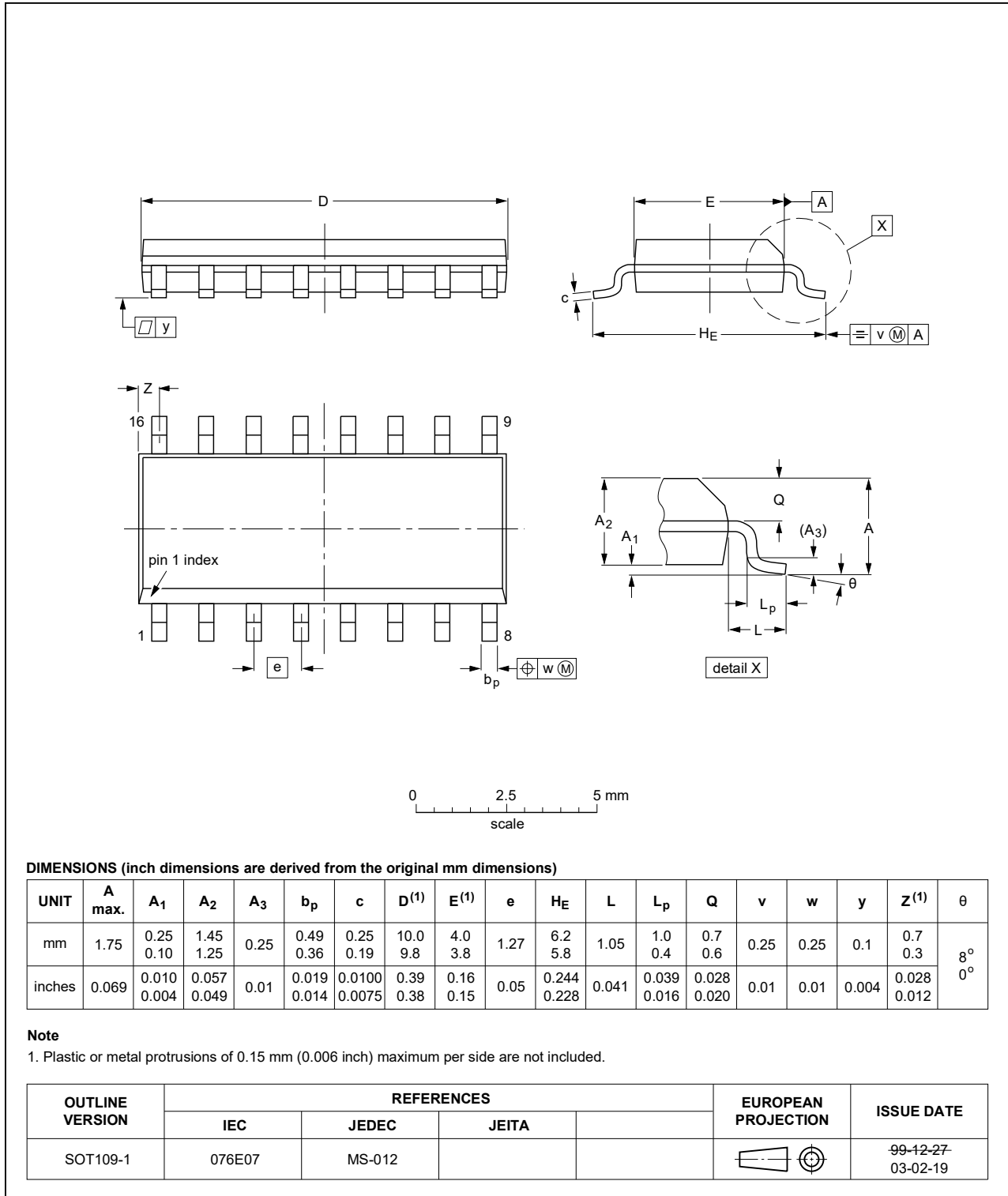

Fig. 7. Package outline SOT109-1 (SO16)



## 13. Abbreviations

Table 11. Abbreviations

Acronym	Description
CMOS	Complementary Metal-Oxide Semiconductor
DUT	Device Under Test
ESD	ElectroStatic Discharge
HBM	Human Body Model
MM	Machine Model

## 14. Revision history

Table 12. Revision history

Document ID	Release date	Data sheet status	Change notice	Supersedes
HEF4043B v.13	20211208	Product data sheet	-	HEF4043B v.12
Modifications:	<ul style="list-style-type: none"> <li>• <a href="#">Section 1</a> and <a href="#">Section 14</a> updated.</li> <li>• <a href="#">Section 13</a> added.</li> </ul>			
HEF4043B v.12	20200130	Product data sheet	-	HEF4043B v.11
Modifications:	<ul style="list-style-type: none"> <li>• The format of this data sheet has been redesigned to comply with the identity guidelines of Nexperia.</li> <li>• Legal texts have been adapted to the new company name where appropriate.</li> <li>• <a href="#">Fig. 2</a>: Typo corrected.</li> </ul>			
HEF4043B v.11	20160324	Product data sheet	-	HEF4043B v.10
Modifications:	<ul style="list-style-type: none"> <li>• Type number HEF4043BP (SOT38-4) removed.</li> </ul>			
HEF4043B v.10	20111118	Product data sheet	-	HEF4043B v.9
Modifications:	<ul style="list-style-type: none"> <li>• <a href="#">Table 6</a>: <math>I_{OH}</math> minimum values changed to maximum</li> </ul>			
HEF4043B v.9	20091216	Product data sheet	-	HEF4043B v.8
HEF4043B v.8	20091127	Product data sheet	-	HEF4043B v.7
HEF4043B v.7	20090710	Product data sheet	-	HEF4043B v.6
HEF4043B v.6	20081111	Product data sheet	-	HEF4043B v.5
HEF4043B v.5	20080729	Product data sheet	-	HEF4043B v.4
HEF4043B v.4	20080710	Product data sheet	-	HEF4043B_CNV v.3
HEF4043B_CNV v.3	19950101	Product specification	-	HEF4043B_CNV v.2
HEF4043B_CNV v.2	19950101	Product specification	-	-

## 15. Legal information

### Data sheet status

Document status [1][2]	Product status [3]	Definition
Objective [short] data sheet	Development	This document contains data from the objective specification for product development.
Preliminary [short] data sheet	Qualification	This document contains data from the preliminary specification.
Product [short] data sheet	Production	This document contains the product specification.

- [1] Please consult the most recently issued document before initiating or completing a design.
- [2] The term 'short data sheet' is explained in section "Definitions".
- [3] The product status of device(s) described in this document may have changed since this document was published and may differ in case of multiple devices. The latest product status information is available on the internet at <https://www.nexperia.com>.

### Definitions

**Draft** — The document is a draft version only. The content is still under internal review and subject to formal approval, which may result in modifications or additions. Nexperia does not give any representations or warranties as to the accuracy or completeness of information included herein and shall have no liability for the consequences of use of such information.

**Short data sheet** — A short data sheet is an extract from a full data sheet with the same product type number(s) and title. A short data sheet is intended for quick reference only and should not be relied upon to contain detailed and full information. For detailed and full information see the relevant full data sheet, which is available on request via the local Nexperia sales office. In case of any inconsistency or conflict with the short data sheet, the full data sheet shall prevail.

**Product specification** — The information and data provided in a Product data sheet shall define the specification of the product as agreed between Nexperia and its customer, unless Nexperia and customer have explicitly agreed otherwise in writing. In no event however, shall an agreement be valid in which the Nexperia product is deemed to offer functions and qualities beyond those described in the Product data sheet.

### Disclaimers

**Limited warranty and liability** — Information in this document is believed to be accurate and reliable. However, Nexperia does not give any representations or warranties, expressed or implied, as to the accuracy or completeness of such information and shall have no liability for the consequences of use of such information. Nexperia takes no responsibility for the content in this document if provided by an information source outside of Nexperia.

In no event shall Nexperia be liable for any indirect, incidental, punitive, special or consequential damages (including - without limitation - lost profits, lost savings, business interruption, costs related to the removal or replacement of any products or rework charges) whether or not such damages are based on tort (including negligence), warranty, breach of contract or any other legal theory.

Notwithstanding any damages that customer might incur for any reason whatsoever, Nexperia's aggregate and cumulative liability towards customer for the products described herein shall be limited in accordance with the Terms and conditions of commercial sale of Nexperia.

**Right to make changes** — Nexperia reserves the right to make changes to information published in this document, including without limitation specifications and product descriptions, at any time and without notice. This document supersedes and replaces all information supplied prior to the publication hereof.

**Suitability for use** — Nexperia products are not designed, authorized or warranted to be suitable for use in life support, life-critical or safety-critical systems or equipment, nor in applications where failure or malfunction of an Nexperia product can reasonably be expected to result in personal

injury, death or severe property or environmental damage. Nexperia and its suppliers accept no liability for inclusion and/or use of Nexperia products in such equipment or applications and therefore such inclusion and/or use is at the customer's own risk.

**Quick reference data** — The Quick reference data is an extract of the product data given in the Limiting values and Characteristics sections of this document, and as such is not complete, exhaustive or legally binding.

**Applications** — Applications that are described herein for any of these products are for illustrative purposes only. Nexperia makes no representation or warranty that such applications will be suitable for the specified use without further testing or modification.

Customers are responsible for the design and operation of their applications and products using Nexperia products, and Nexperia accepts no liability for any assistance with applications or customer product design. It is customer's sole responsibility to determine whether the Nexperia product is suitable and fit for the customer's applications and products planned, as well as for the planned application and use of customer's third party customer(s). Customers should provide appropriate design and operating safeguards to minimize the risks associated with their applications and products.

Nexperia does not accept any liability related to any default, damage, costs or problem which is based on any weakness or default in the customer's applications or products, or the application or use by customer's third party customer(s). Customer is responsible for doing all necessary testing for the customer's applications and products using Nexperia products in order to avoid a default of the applications and the products or of the application or use by customer's third party customer(s). Nexperia does not accept any liability in this respect.

**Limiting values** — Stress above one or more limiting values (as defined in the Absolute Maximum Ratings System of IEC 60134) will cause permanent damage to the device. Limiting values are stress ratings only and (proper) operation of the device at these or any other conditions above those given in the Recommended operating conditions section (if present) or the Characteristics sections of this document is not warranted. Constant or repeated exposure to limiting values will permanently and irreversibly affect the quality and reliability of the device.

**Terms and conditions of commercial sale** — Nexperia products are sold subject to the general terms and conditions of commercial sale, as published at <http://www.nexperia.com/profile/terms>, unless otherwise agreed in a valid written individual agreement. In case an individual agreement is concluded only the terms and conditions of the respective agreement shall apply. Nexperia hereby expressly objects to applying the customer's general terms and conditions with regard to the purchase of Nexperia products by customer.

**No offer to sell or license** — Nothing in this document may be interpreted or construed as an offer to sell products that is open for acceptance or the grant, conveyance or implication of any license under any copyrights, patents or other industrial or intellectual property rights.

**Export control** — This document as well as the item(s) described herein may be subject to export control regulations. Export might require a prior authorization from competent authorities.

**Non-automotive qualified products** — Unless this data sheet expressly states that this specific Nexperia product is automotive qualified, the product is not suitable for automotive use. It is neither qualified nor tested in accordance with automotive testing or application requirements. Nexperia accepts no liability for inclusion and/or use of non-automotive qualified products in automotive equipment or applications.

In the event that customer uses the product for design-in and use in automotive applications to automotive specifications and standards, customer (a) shall use the product without Nexperia's warranty of the product for such automotive applications, use and specifications, and (b) whenever customer uses the product for automotive applications beyond Nexperia's specifications such use shall be solely at customer's own risk, and (c) customer fully indemnifies Nexperia for any liability, damages or failed product claims resulting from customer design and use of the product for automotive applications beyond Nexperia's standard warranty and Nexperia's product specifications.

**Translations** — A non-English (translated) version of a document is for reference only. The English version shall prevail in case of any discrepancy between the translated and English versions.

### Trademarks

Notice: All referenced brands, product names, service names and trademarks are the property of their respective owners.

## Contents

<b>1. General description</b> .....	<b>1</b>
<b>2. Features and benefits</b> .....	<b>1</b>
<b>3. Applications</b> .....	<b>1</b>
<b>4. Ordering information</b> .....	<b>1</b>
<b>5. Functional diagram</b> .....	<b>2</b>
<b>6. Pinning information</b> .....	<b>2</b>
6.1. Pinning.....	2
6.2. Pin description.....	3
<b>7. Functional description</b> .....	<b>3</b>
<b>8. Limiting values</b> .....	<b>3</b>
<b>9. Recommended operating conditions</b> .....	<b>4</b>
<b>10. Static characteristics</b> .....	<b>4</b>
<b>11. Dynamic characteristics</b> .....	<b>5</b>
11.1. Waveforms and test circuit.....	6
<b>12. Package outline</b> .....	<b>8</b>
<b>13. Abbreviations</b> .....	<b>9</b>
<b>14. Revision history</b> .....	<b>9</b>
<b>15. Legal information</b> .....	<b>10</b>

© Nexperia B.V. 2021. All rights reserved

For more information, please visit: <http://www.nexperia.com>

For sales office addresses, please send an email to: [salesaddresses@nexperia.com](mailto:salesaddresses@nexperia.com)

Date of release: 8 December 2021

## X-ON Electronics

Largest Supplier of Electrical and Electronic Components

*Click to view similar products for [Latches](#) category:*

*Click to view products by [Nexperia](#) manufacturer:*

Other Similar products are found below :

[ML4875CS-5](#) [401639B](#) [716165RB](#) [74F373DW](#) [74LVC373ADTR2G](#) [74LVC573ADTR2G](#) [NL17SG373DFT2G](#) [NLV14044BDG](#) [5962-8863901RA](#) [5962-88639012A](#) [NLV14042BDR2G](#) [74HC573D,653](#) [2.L18.001-21](#) [2.PM18.002-18](#) [2.PM18.006-18](#) [2.T18.001-21](#) [2.T18.002-18](#) [2.T18.006-18](#) [CQ/AA-KEY](#) [CQ/A-M22X1,5-45-28](#) [CQ/A-M22X1,5-45-32](#) [M22-2-D5-2-21-01-P](#) [CY74FCT2373CTSOC](#) [421283](#) [MM74HC373WM](#) [MM74HC573WM](#) [74LCX373MTC](#) [74LVT16373MTDX](#) [74VHC373MX](#) [KLD5.001-02](#) [Z-0233-827-15](#) [MIC58P01YV](#) [74AHCT573D.112](#) [74LCX16373MTDX](#) [CQ/A-M22X1,5-45-16](#) [CQ/A-M22X1,5-45-18](#) [CQ/A-M22X1,5-45-20](#) [CQ/A-M22X1,5-45-24](#) [CQ/A-M22X1,5-45-30](#) [CQT/A-32-18 AE-V0](#) [CQT/A-32 20-AE-V0](#) [CQT/A-32 32-AE-V0](#) [Z-2106-25001-22](#) [2.904.005](#) [2.904.006](#) [2.904.008](#) [2.KLB-KW8.001PA-07](#) [2.KLB-T9.001PA-07](#) [2.KL-T9.002-02](#) [2.L18.001-18](#)