

RF Power Field Effect Transistors

N-Channel Enhancement-Mode Lateral MOSFETs

Designed primarily for CW large-signal output and driver applications with frequencies up to 600 MHz. Devices are unmatched and are suitable for use in industrial, medical and scientific applications.

- Typical CW Performance: $V_{DD} = 50$ Volts, $I_{DQ} = 900$ mA,
 $P_{out} = 300$ Watts, $f = 220$ MHz
 Power Gain — 25.5 dB
 Drain Efficiency — 68%
- Capable of Handling 10:1 VSWR, @ 50 Vdc, 220 MHz, 300 Watts CW Output Power

Features

- Characterized with Series Equivalent Large-Signal Impedance Parameters
- Qualified Up to a Maximum of 50 V_{DD} Operation
- Integrated ESD Protection
- 225°C Capable Plastic Package
- RoHS Compliant
- In Tape and Reel. R1 Suffix = 500 Units per 44 mm, 13 inch Reel.

MRF6V2300NR1
MRF6V2300NBR1

10-600 MHz, 300 W, 50 V
LATERAL N-CHANNEL
SINGLE-ENDED
BROADBAND
RF POWER MOSFETs



PARTS ARE SINGLE-ENDED

Table 1. Maximum Ratings

Rating	Symbol	Value	Unit
Drain-Source Voltage	V_{DSS}	-0.5, +110	Vdc
Gate-Source Voltage	V_{GS}	-0.5, +10	Vdc
Storage Temperature Range	T_{stg}	-65 to +150	°C
Case Operating Temperature	T_C	150	°C
Operating Junction Temperature (1,2)	T_J	225	°C

Table 2. Thermal Characteristics

Characteristic	Symbol	Value (2,3)	Unit
Thermal Resistance, Junction to Case Case Temperature 83°C, 300 W CW	$R_{\theta JC}$	0.24	°C/W

Table 3. ESD Protection Characteristics

Test Methodology	Class
Human Body Model (per JESD22-A114)	2 (Minimum)
Machine Model (per EIA/JESD22-A115)	A (Minimum)
Charge Device Model (per JESD22-C101)	IV (Minimum)

1. Continuous use at maximum temperature will affect MTTF.
2. MTTF calculator available at <http://www.freescale.com/rf>. Select Software & Tools/Development Tools/Calculators to access MTTF calculators by product.
3. Refer to AN1955, *Thermal Measurement Methodology of RF Power Amplifiers*. Go to <http://www.freescale.com/rf>. Select Documentation/Application Notes - AN1955.

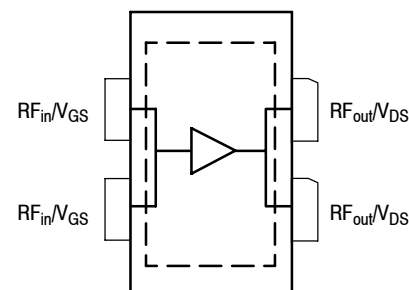

(Top View)

Note: Exposed backside of the package is the source terminal for the transistor.

Figure 1. Pin Connections

Table 4. Moisture Sensitivity Level

Test Methodology	Rating	Package Peak Temperature	Unit
Per JESD22-A113, IPC/JEDEC J-STD-020	3	260	°C

Table 5. Electrical Characteristics ($T_A = 25^\circ\text{C}$ unless otherwise noted)

Characteristic	Symbol	Min	Typ	Max	Unit
----------------	--------	-----	-----	-----	------

Off Characteristics

Zero Gate Voltage Drain Leakage Current ($V_{DS} = 100\text{ Vdc}$, $V_{GS} = 0\text{ Vdc}$)	I_{DSS}	—	—	2.5	mA
Zero Gate Voltage Drain Leakage Current ($V_{DS} = 50\text{ Vdc}$, $V_{GS} = 0\text{ Vdc}$)	I_{DSS}	—	—	50	μA
Drain-Source Breakdown Voltage ($I_D = 150\text{ mA}$, $V_{GS} = 0\text{ Vdc}$)	$V_{(BR)DSS}$	110	—	—	Vdc
Gate-Source Leakage Current ($V_{GS} = 5\text{ Vdc}$, $V_{DS} = 0\text{ Vdc}$)	I_{GSS}	—	—	10	μA

On Characteristics

Gate Threshold Voltage ($V_{DS} = 10\text{ Vdc}$, $I_D = 800\ \mu\text{A}$)	$V_{GS(th)}$	1	1.63	3	Vdc
Gate Quiescent Voltage ($V_{DD} = 50\text{ Vdc}$, $I_D = 900\text{ mA}$, Measured in Functional Test)	$V_{GS(Q)}$	1.5	2.6	3.5	Vdc
Drain-Source On-Voltage ($V_{GS} = 10\text{ Vdc}$, $I_D = 2\text{ A}$)	$V_{DS(on)}$	—	0.28	—	Vdc

Dynamic Characteristics

Reverse Transfer Capacitance ($V_{DS} = 50\text{ Vdc} \pm 30\text{ mV(rms)}$ ac @ 1 MHz, $V_{GS} = 0\text{ Vdc}$)	C_{rss}	—	2.88	—	pF
Output Capacitance ($V_{DS} = 50\text{ Vdc} \pm 30\text{ mV(rms)}$ ac @ 1 MHz, $V_{GS} = 0\text{ Vdc}$)	C_{oss}	—	120	—	pF
Input Capacitance ($V_{DS} = 50\text{ Vdc}$, $V_{GS} = 0\text{ Vdc} \pm 30\text{ mV(rms)}$ ac @ 1 MHz)	C_{iss}	—	268	—	pF

Functional Tests (In Freescale Test Fixture, 50 ohm system) $V_{DD} = 50\text{ Vdc}$, $I_{DQ} = 900\text{ mA}$, $P_{out} = 300\text{ W}$, $f = 220\text{ MHz}$, CW

Power Gain	G_{ps}	24	25.5	27	dB
Drain Efficiency	η_D	66	68	—	%
Input Return Loss	IRL	—	-16	-9	dB

Typical Performances (In Freescale 27 MHz and 450 MHz Test Fixtures, 50 ohm system) $V_{DD} = 50\text{ Vdc}$, $I_{DQ} = 900\text{ mA}$, $P_{out} = 300\text{ W}$ CW

Power Gain	$f = 27\text{ MHz}$	G_{ps}	—	31.4	—	dB
	$f = 450\text{ MHz}$		—	21.7	—	
Drain Efficiency	$f = 27\text{ MHz}$	η_D	—	61.5	—	%
	$f = 450\text{ MHz}$		—	59.1	—	
Input Return Loss	$f = 27\text{ MHz}$	IRL	—	-17.4	—	dB
	$f = 450\text{ MHz}$		—	-24.4	—	



ATTENTION: The MRF6V2300N and MRF6V2300NB are high power devices and special considerations must be followed in board design and mounting. Incorrect mounting can lead to internal temperatures which exceed the maximum allowable operating junction temperature. Refer to Freescale Application Note AN3263 (for bolt down mounting) or AN1907 (for solder reflow mounting) **PRIOR TO STARTING SYSTEM DESIGN** to ensure proper mounting of these devices.

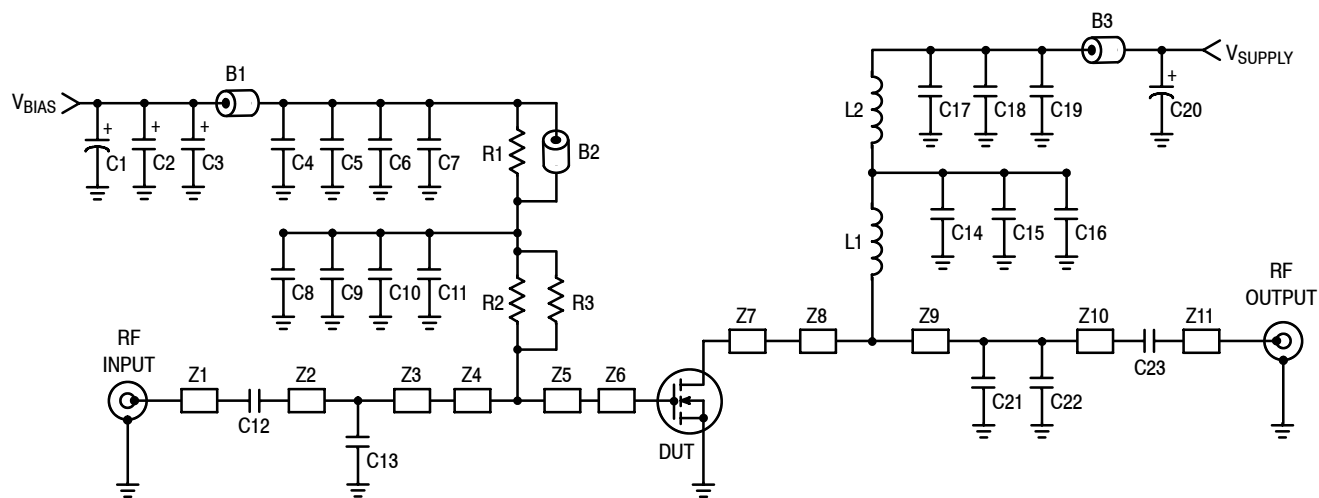

Z1	0.352" x 0.082" Microstrip	Z8	0.085" x 0.170" Microstrip
Z2	1.567" x 0.082" Microstrip	Z9	2.275" x 0.170" Microstrip
Z3	0.857" x 0.082" Microstrip	Z10	0.945" x 0.170" Microstrip
Z4	0.276" x 0.220" Microstrip	Z11	0.443" x 0.082" Microstrip
Z5	0.434" x 0.220" Microstrip	PCB	Arlon CuClad 250GX-0300-55-22, 0.030", $\epsilon_r = 2.55$
Z6, Z7	0.298" x 0.630" Microstrip		

Figure 2. MRF6V2300NR1(NBR1) Test Circuit Schematic — 220 MHz

Table 6. MRF6V2300NR1(NBR1) Test Circuit Component Designations and Values — 220 MHz

Part	Description	Part Number	Manufacturer
B1, B2	95 Ω , 100 MHz Long Ferrite Beads, Surface Mount	2743021447	Fair-Rite
B3	47 Ω , 100 MHz Short Ferrite Bead, Surface Mount	2743019447	Fair-Rite
C1	47 μ F, 50 V Electrolytic Capacitor	476KXM063M	Illinois Capacitor
C2	22 μ F, 35 V Tantalum Capacitor	T494X226K035AT	Kemet
C3	10 μ F, 35 V Tantalum Capacitor	T491D106K035AT	Kemet
C4, C19	10 K pF Chip Capacitors	ATC200B103KT50XT	ATC
C5, C18	20 K pF Chip Capacitors	ATC200B203KT50XT	ATC
C6, C11, C17	0.1 μ F, 50 V Chip Capacitors	CDR33BX104AKYS	AVX
C7, C8, C15, C16	2.2 μ F, 50 V Chip Capacitors	C1825C225J5RAC	Kemet
C10	220 nF Chip Capacitor	C1206C224Z5VAC	Kemet
C9, C12, C14, C23	1000 pF Chip Capacitors	ATC100B102JT50XT	ATC
C13	82 pF Chip Capacitor	ATC100B820JT500XT	ATC
C20	470 μ F, 63 V Electrolytic Capacitor	477KXM063M	Illinois Capacitor
C21	24 pF Chip Capacitor	ATC100B240JT500XT	ATC
C22	39 pF Chip Capacitor	ATC100B390JT500XT	ATC
L1	4 Turn #18 AWG, 0.18" ID	None	None
L2	82 nH Inductor	1812SMS-82NJ	Coilcraft
R1	270 Ω , 1/4 W Chip Resistor	CRCW12062700FKTA	Vishay
R2, R3	4.75 Ω , 1/4 W Chip Resistors	CRCW12064R75FKTA	Vishay

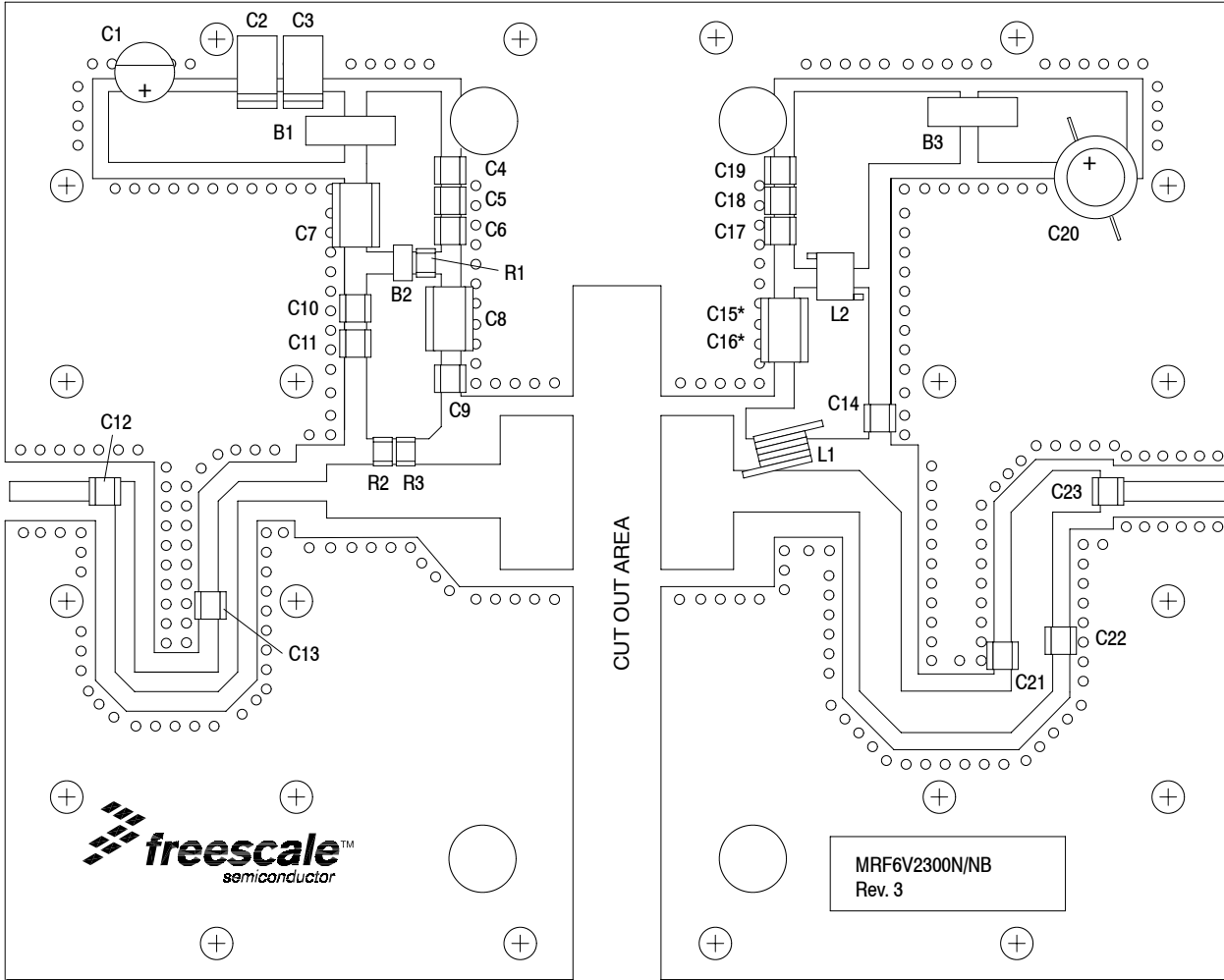

* Stacked

Figure 3. MRF6V2300NR1(NBR1) Test Circuit Component Layout — 220 MHz

TYPICAL CHARACTERISTICS

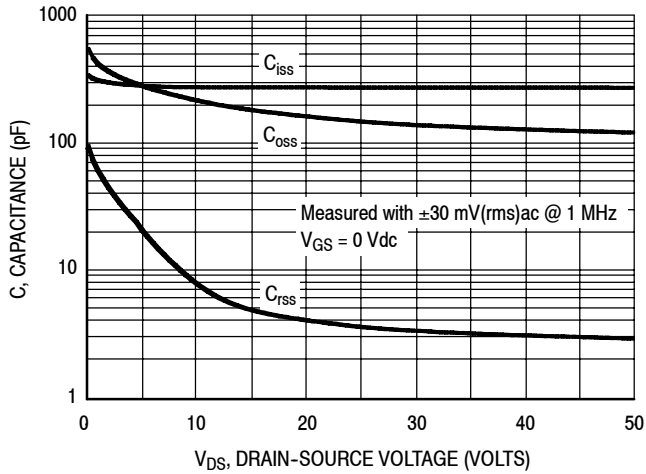

Figure 4. Capacitance versus Drain-Source Voltage

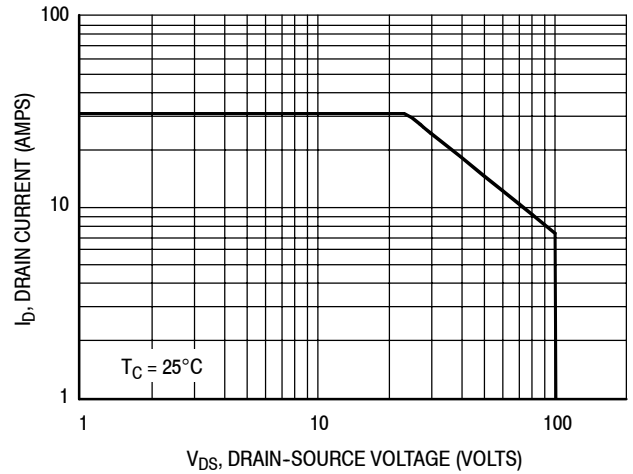

Figure 5. DC Safe Operating Area

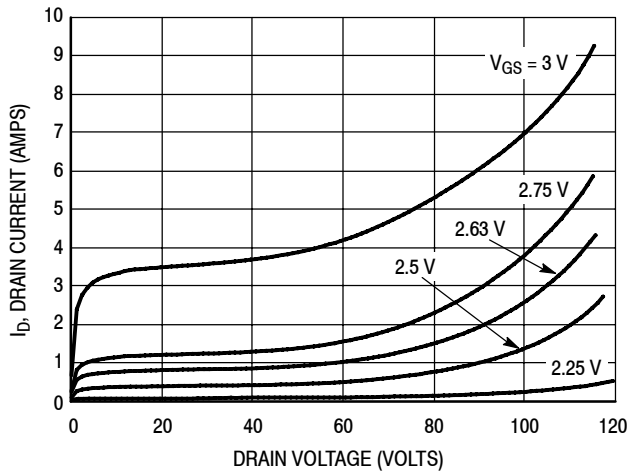

Figure 6. DC Drain Current versus Drain Voltage

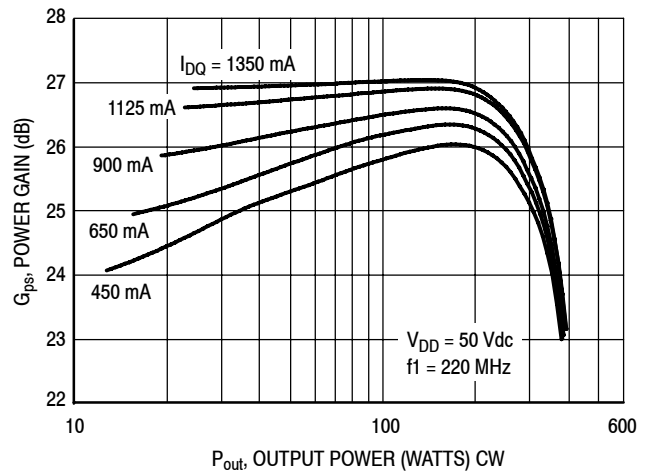

Figure 7. CW Power Gain versus Output Power

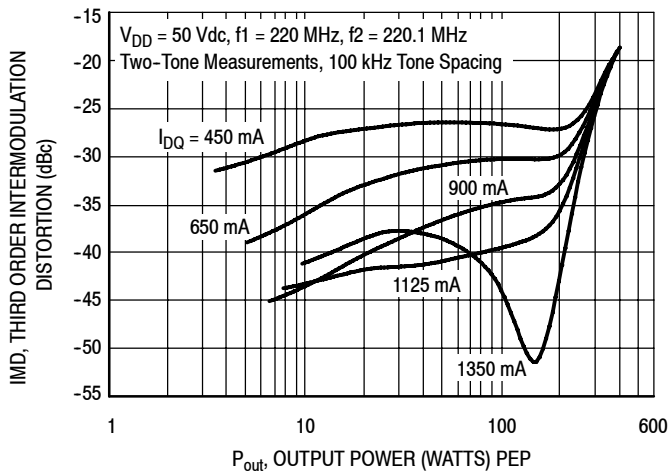

Figure 8. Third Order Intermodulation Distortion versus Output Power

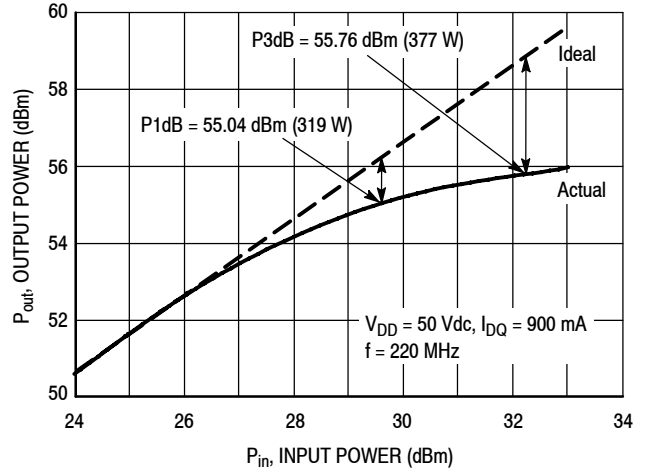

Figure 9. CW Output Power versus Input Power

TYPICAL CHARACTERISTICS

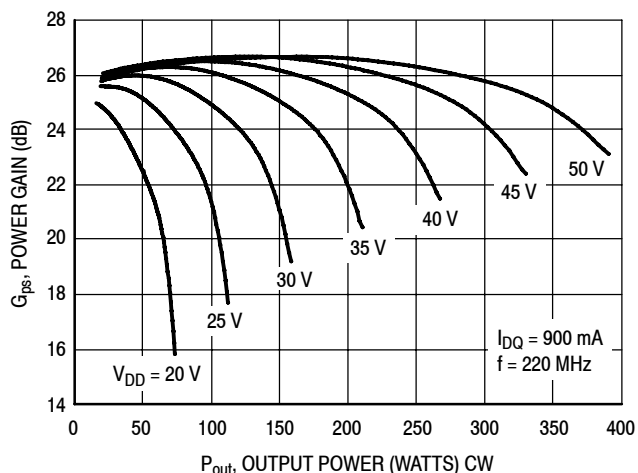

Figure 10. Power Gain versus Output Power

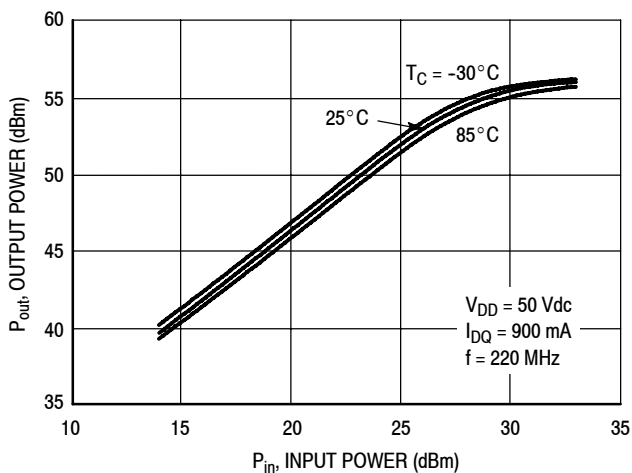

Figure 11. Power Output versus Power Input

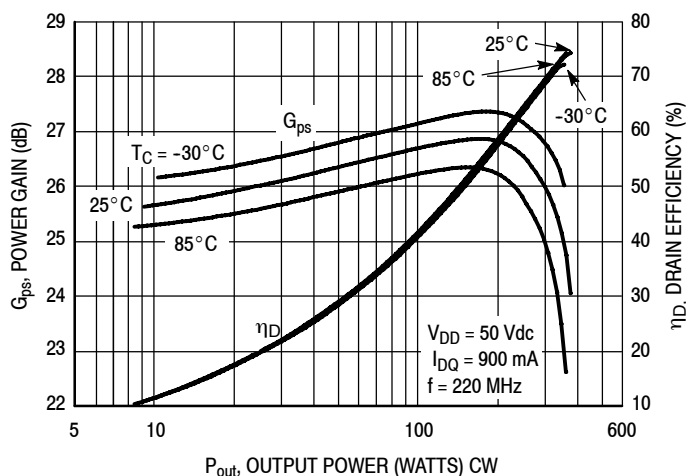

Figure 12. Power Gain and Drain Efficiency versus CW Output Power

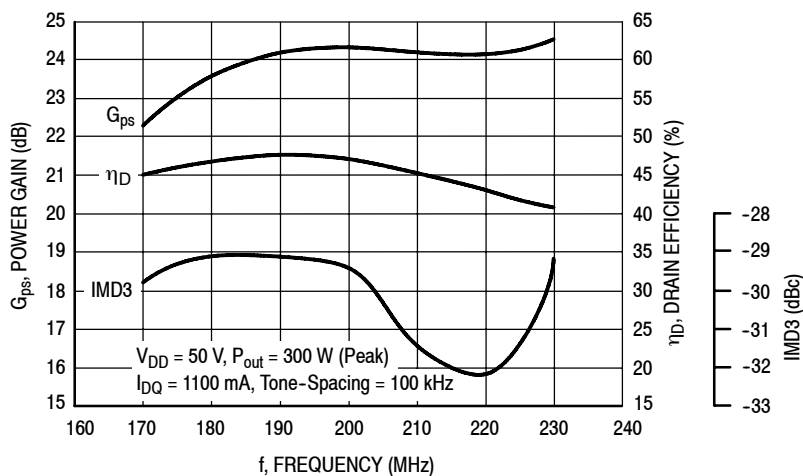
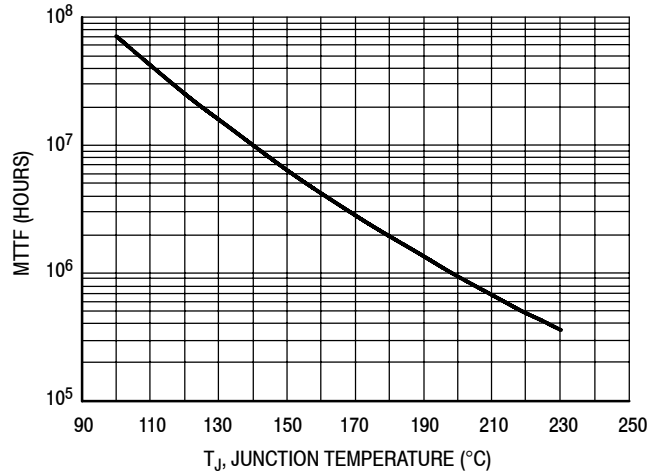

Figure 13. VHF Broadcast Broadband Performance

TYPICAL CHARACTERISTICS



This above graph displays calculated MTTF in hours when the device is operated at $V_{DD} = 50$ Vdc, $P_{out} = 300$ W CW, and $\eta_D = 68\%$.

MTTF calculator available at <http://www.freescale.com/rf>. Select Software & Tools/Development Tools/Calculators to access MTTF calculators by product.

Figure 14. MTTF versus Junction Temperature

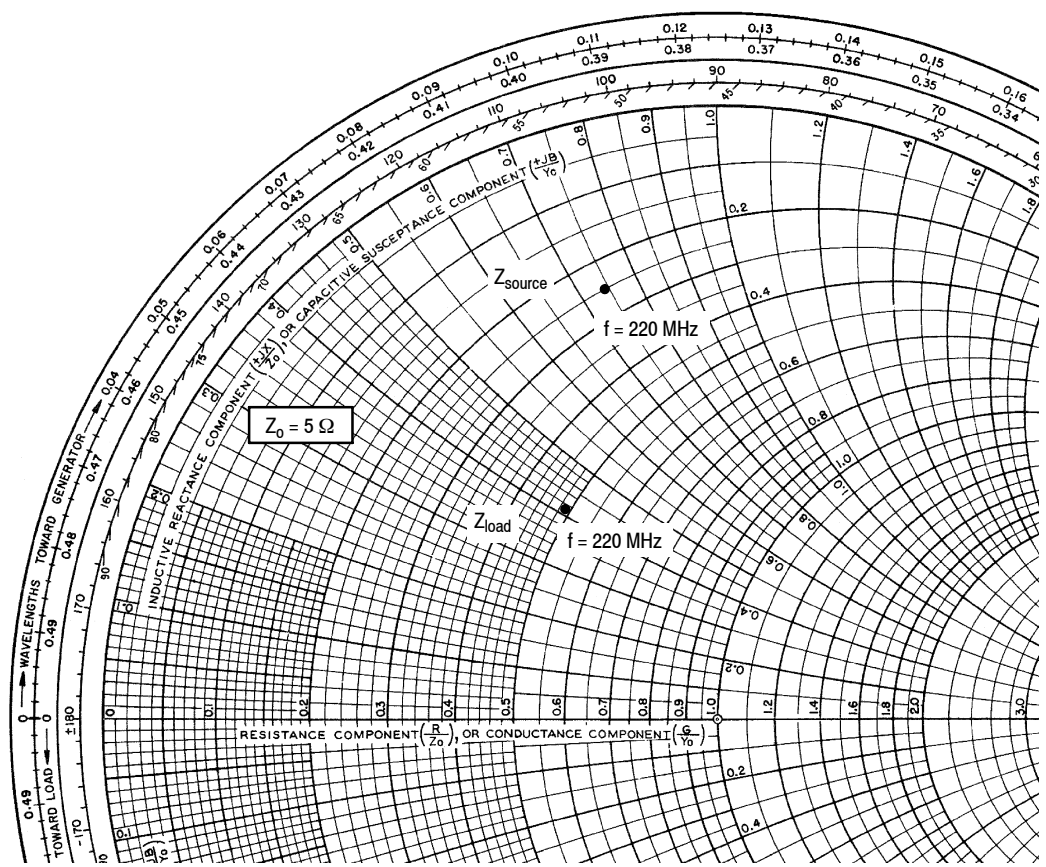

$V_{DD} = 50 \text{ Vdc}$, $I_{DQ} = 900 \text{ mA}$, $P_{out} = 300 \text{ W CW}$

f MHz	Z_{source} Ω	Z_{load} Ω
220	$1.23 + j3.69$	$2.43 + j2.04$

Z_{source} = Test circuit impedance as measured from gate to ground.

Z_{load} = Test circuit impedance as measured from drain to ground.

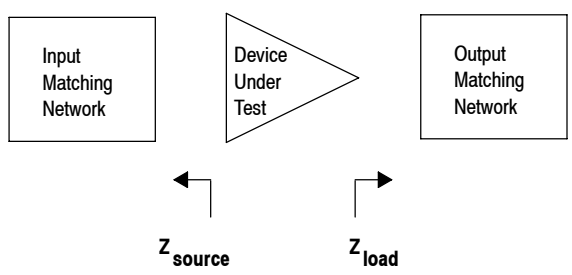

Figure 15. Series Equivalent Source and Load Impedance — 220 MHz

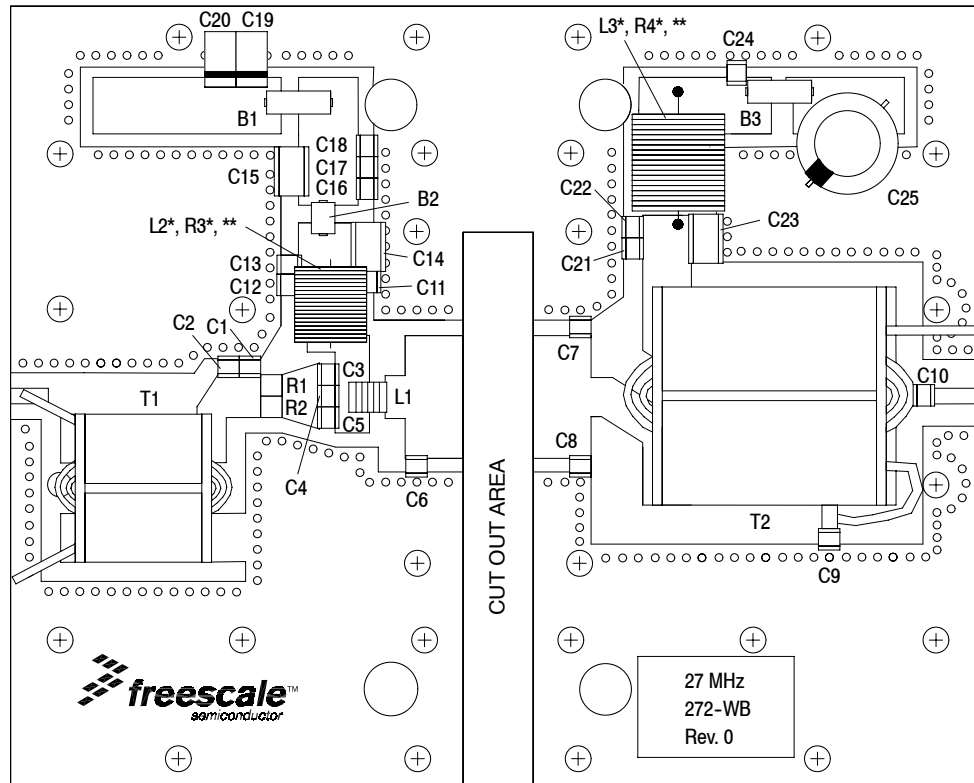

Figure 16. MRF6V2300NR1 (NBR1) Test Circuit Component Layout — 27 MHz

Table 7. MRF6V2300NR1 (NBR1) Test Circuit Component Designations and Values — 27 MHz

Part	Description	Part Number	Manufacturer
B1, B3	95 Ω , 100 MHz Long Ferrite Beads	2743021447	Fair-Rite
B2	47 Ω , 100 MHz Short Ferrite Bead	2743019447	Fair-Rite
C1	160 pF Chip Capacitor	ATC100B161JT500XT	ATC
C2	620 pF Chip Capacitor	ATC100B621JT100XT	ATC
C3, C4, C5	1000 pF Chip Capacitors	ATC100B102JT50XT	ATC
C6	68 pF Chip Capacitor	ATC100B680JT500XT	ATC
C7, C8	330 pF Chip Capacitors	ATC100B331JT200XT	ATC
C9	51 pF Chip Capacitor	ATC100B510GT500XT	ATC
C10	240 pF Chip Capacitor	ATC100B241JT200XT	ATC
C11, C16, C24	0.1 μ F Chip Capacitors	CDR33BX104AKYS	Kemet
C12, C17	22K pF Chip Capacitors	ATC200B223KT50XT	ATC
C13	0.22 μ F, 50 V Chip Capacitor	C1812C224K5RAC-TU	Kemet
C14, C15	2.2 μ F, 50 V Chip Capacitors	C1825C225J5RAC-TU	Kemet
C18, C21, C22	39K pF Chip Capacitors	ATC200B393KT50XT	ATC
C19	10 μ F, 35 V Tantalum Capacitor	T491D106K035AT	Kemet
C20	22 μ F, 35 V Tantalum Capacitor	T491X226K035AT	Kemet
C23	0.01 μ F, 100 V Chip Capacitor	C1825C103K1GAC-TU	Kemet
C25	470 μ F, 63 V Electrolytic Capacitor	MCGPR63V477M13X26-RH	Multicomp
L1	100 nH Inductor	1812SMS-R10J	Coilcraft
L2*	11 Turn, #16 AWG, Inductor, Hand Wound, 0.375" ID	Copper Wire	
L3*	9 Turn, #16 AWG, Inductor, Hand Wound, 0.375" ID	Copper Wire	
R1, R2	3.3 Ω , 1/4 W Chip Resistors	RK73B2ETTD3R3J	KOA
R3*, **	110 Ω , 1/4 W Carbon Resistor	MCCFR0W4J0111A50	Multicomp
R4*, **	510 Ω , 1/2 W Carbon Resistor	MCRC1/2G511JT-RH	Multicomp
T1	RF600 Transformer 16:1 Impedance Ratio	RF600LF-16	Comm Concepts
T2	RF1000 Transformer 9:1 Impedance Ratio	RF1000LF-9	Comm Concepts

* Leaded components mounted over traces.

** Resistor is mounted at center of inductor coil.

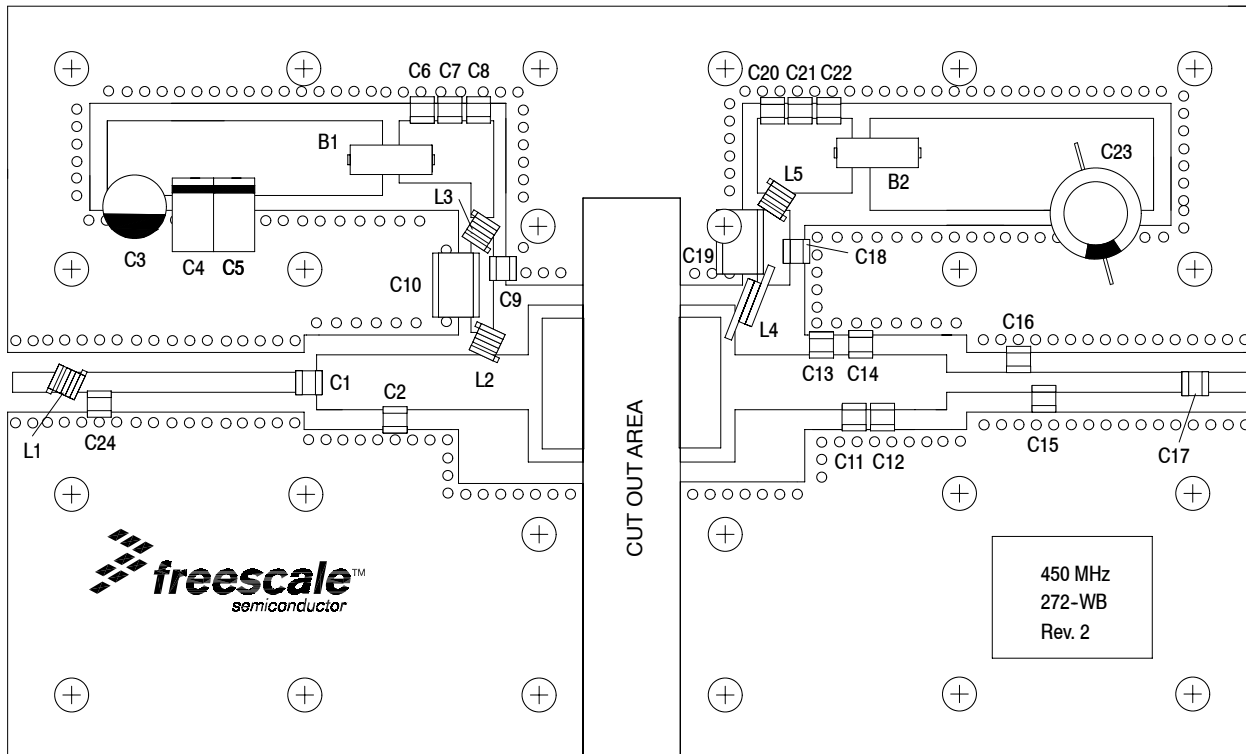
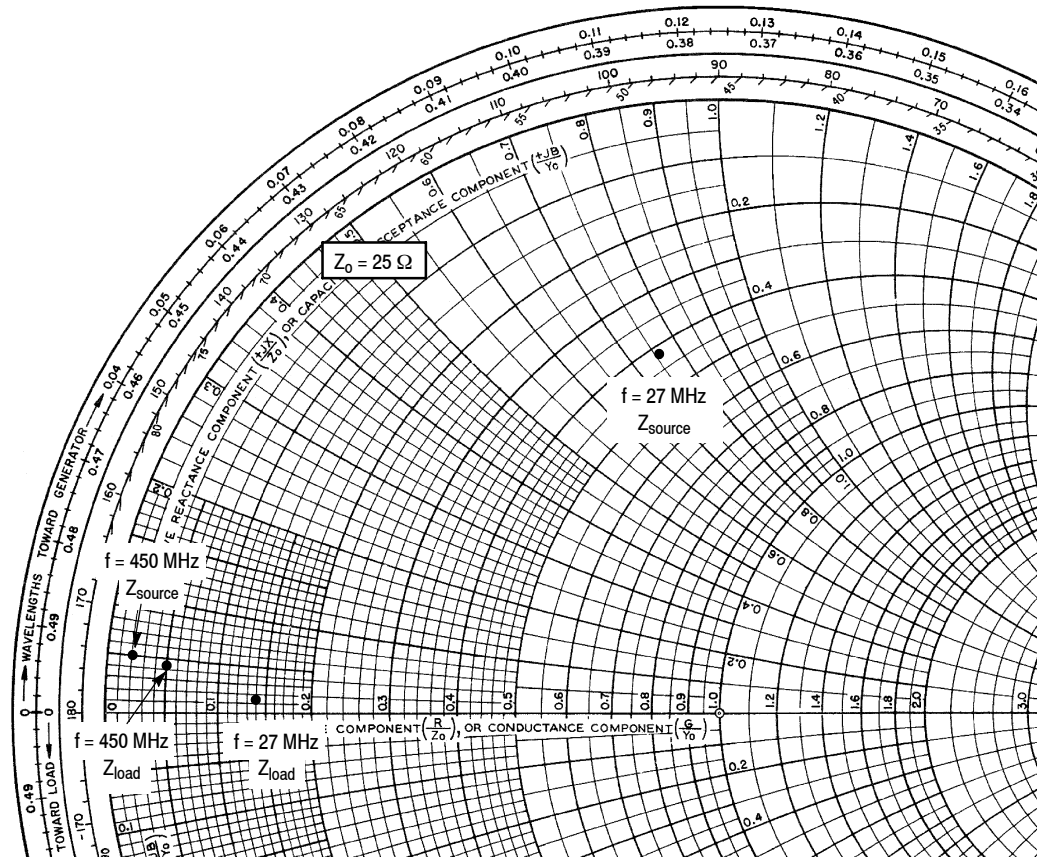

Figure 17. MRF6V2300NR1(NBR1) Test Circuit Component Layout — 450 MHz

Table 8. MRF6V2300NR1(NBR1) Test Circuit Component Designations and Values — 450 MHz

Part	Description	Part Number	Manufacturer
B1, B2	95 Ω , 100 MHz Long Ferrite Beads	2743021447	Fair-Rite
C1, C9, C17, C18	240 pF Chip Capacitors	ATC100B241JT50XT	ATC
C2	47 pF Chip Capacitor	ATC100B470JT500XT	ATC
C3	47 μ F, 50 V Electrolytic Capacitor	476KXM050M	Illinois Capacitor
C4	22 μ F, 35 V Tantalum Capacitor	T491X226K035AT	Kemet
C5	10 μ F, 35 V Tantalum Capacitor	T491D106K035AT	Kemet
C6, C20	10K pF Chip Capacitors	ATC200B103KT50XT	ATC
C7, C21	20K pF Chip Capacitors	ATC200B203KT50XT	ATC
C8, C22	0.1 μ F Chip Capacitors	CDR33BX104AKYS	AVX
C10, C19	2.2 μ F, 50 V Chip Capacitors	C1825C225J5RAC-TU	Kemet
C11, C13	15 pF Chip Capacitors	ATC100B150JT500XT	Kemet
C12, C14	6.8 pF Chip Capacitors	ATC100B6R8JT500XT	ATC
C15	9.1 pF Chip Capacitor	ATC100B120JT500XT	ATC
C16	10 pF Chip Capacitor	ATC100B100JT500XT	ATC
C23	470 μ F, 63 V Electrolytic Capacitor	MCGPR63V477M13X26-RH	Multicomp
C24	2 pF Chip Capacitor	ATC100B2R0JT500X	ATC
L1	12.5 nH Inductor	A04TJLC	Coilcraft
L2	8 nH Inductor	A03TKLC	Coilcraft
L3, L5	82 nH, Midi Springs	1812SMS-82NJLC	Coilcraft
L4	2 Turn, #18 AWG, Inductor, Hand Wound, 0.090" ID	Copper Wire	
PCB	Arlon CuClad 250GX-0300-55-22, 0.030", $\epsilon_r = 2.55$	DS2054	DS Electronics



$V_{DD} = 50 \text{ Vdc}$, $I_{DQ} = 900 \text{ mA}$, $P_{out} = 300 \text{ W CW}$

f MHz	Z_{source} Ω	Z_{load} Ω
27	$10.5 + j19.0$	$3.50 + j0.19$
450	$0.50 + j1.37$	$1.25 + j0.99$

Z_{source} = Test circuit impedance as measured from gate to ground.

Z_{load} = Test circuit impedance as measured from drain to ground.

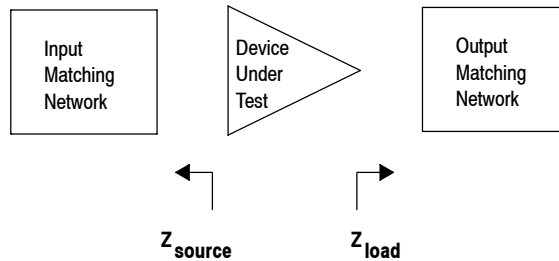
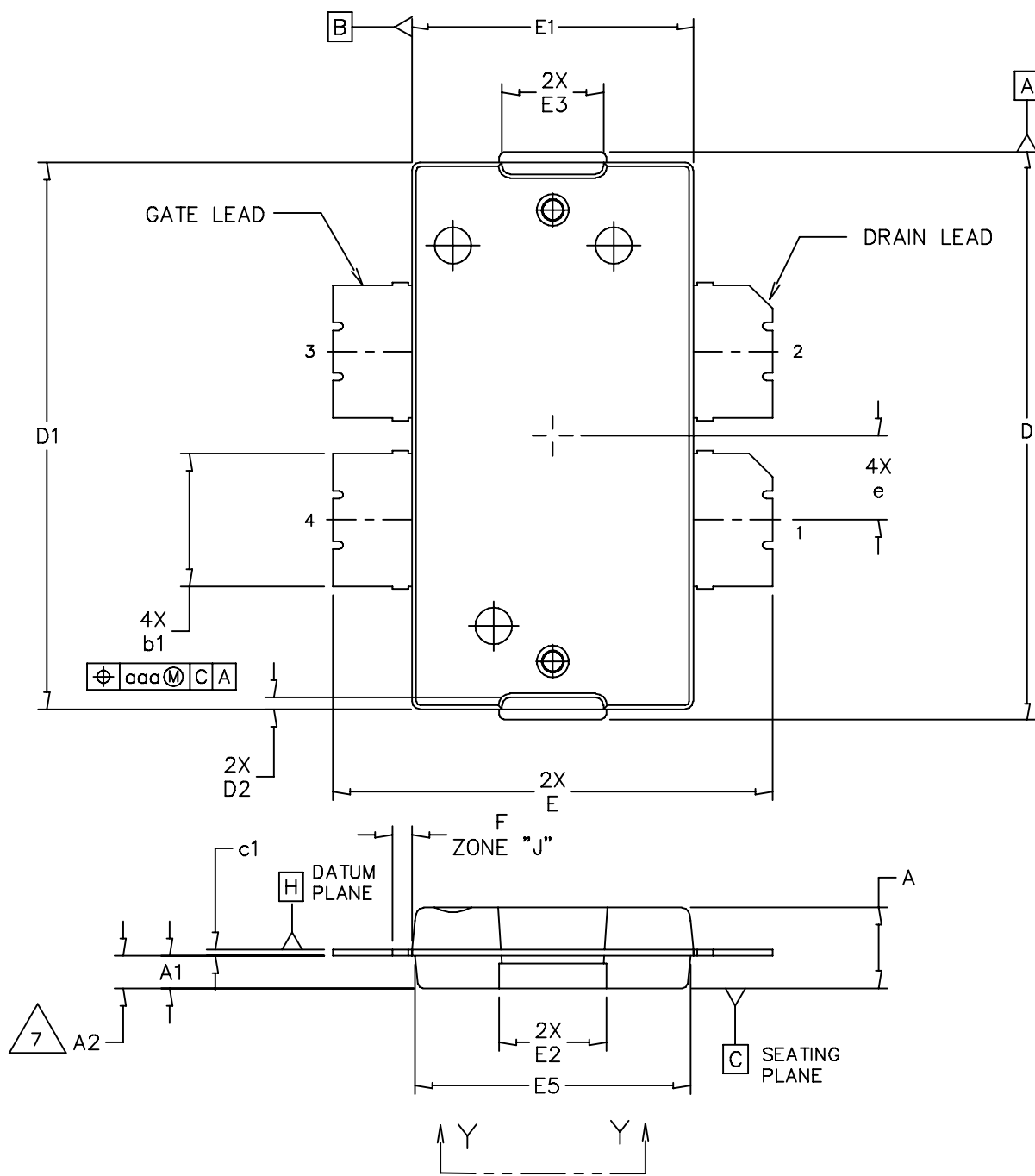
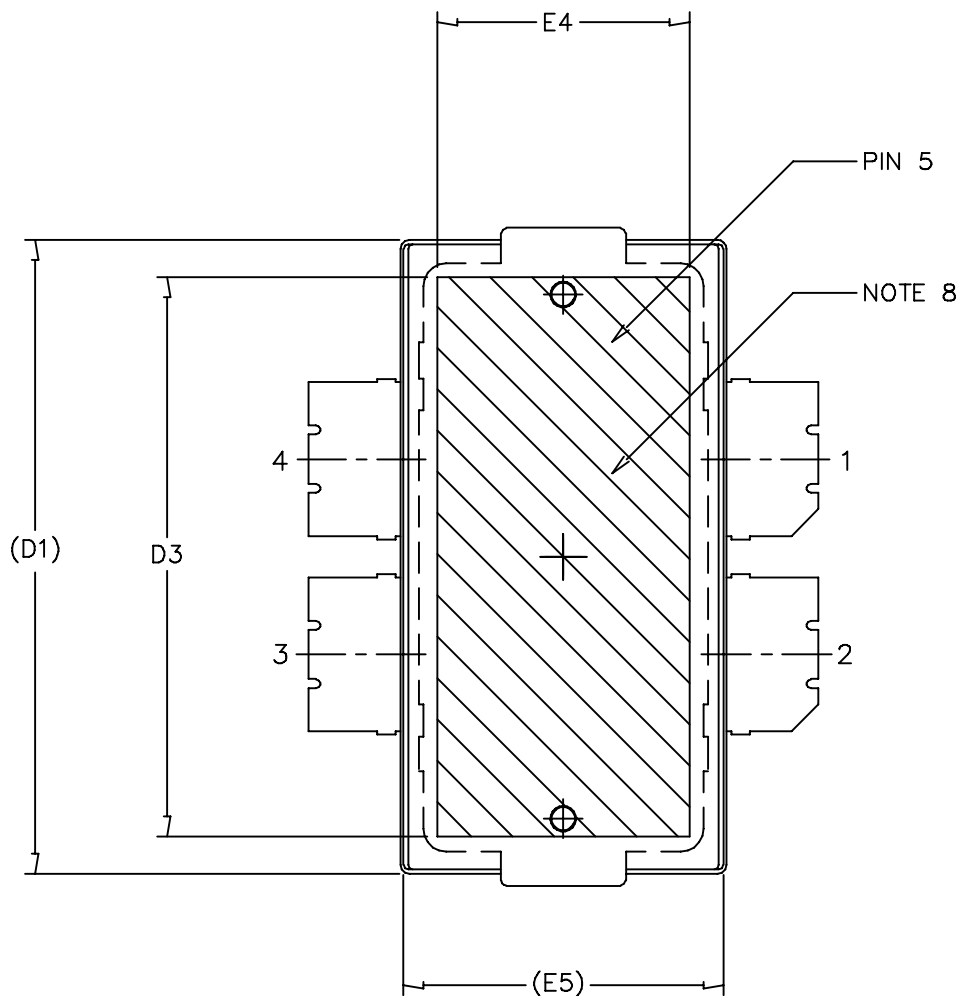

Figure 18. Series Equivalent Source and Load Impedance — 27, 450 MHz

PACKAGE DIMENSIONS



© FREESCALE SEMICONDUCTOR, INC. ALL RIGHTS RESERVED.		MECHANICAL OUTLINE		PRINT VERSION NOT TO SCALE	
TITLE: TO-270 4 LEAD, WIDE BODY		DOCUMENT NO: 98ASA10577D		REV: D	
		CASE NUMBER: 1486-03		13 AUG 2007	
		STANDARD: NON-JEDEC			



© FREESCALE SEMICONDUCTOR, INC. ALL RIGHTS RESERVED.	MECHANICAL OUTLINE	PRINT VERSION NOT TO SCALE	
TITLE: TO-270 4 LEAD, WIDE BODY	DOCUMENT NO: 98ASA10577D	REV: D	
	CASE NUMBER: 1486-03	13 AUG 2007	
	STANDARD: NON-JEDEC		

NOTES:

1. CONTROLLING DIMENSION: INCH
2. INTERPRET DIMENSIONS AND TOLERANCES PER ASME Y14.5M-1994.
3. DATUM PLANE -H- IS LOCATED AT THE TOP OF LEAD AND IS COINCIDENT WITH THE LEAD WHERE THE LEAD EXITS THE PLASTIC BODY AT THE TOP OF THE PARTING LINE.
4. DIMENSIONS "D" AND "E1" DO NOT INCLUDE MOLD PROTRUSION. ALLOWABLE PROTRUSION IS .006 PER SIDE. DIMENSIONS "D" AND "E1" DO INCLUDE MOLD MISMATCH AND ARE DETERMINED AT DATUM PLANE -H-.
5. DIMENSIONS "b1" DOES NOT INCLUDE DAMBAR PROTRUSION. ALLOWABLE DAMBAR PROTRUSION SHALL BE .005 TOTAL IN EXCESS OF THE "b1" DIMENSION AT MAXIMUM MATERIAL CONDITION.
6. DATUMS -A- AND -B- TO BE DETERMINED AT DATUM PLANE -H-.
7. DIMENSION A2 APPLIES WITHIN ZONE "J" ONLY.
8. HATCHING REPRESENTS THE EXPOSED AREA OF THE HEAT SLUG.

STYLE 1:

PIN 1 - DRAIN PIN 2 - DRAIN
 PIN 3 - GATE PIN 4 - GATE
 PIN 5 - SOURCE

DIM	INCH		MILLIMETER		DIM	INCH		MILLIMETER	
	MIN	MAX	MIN	MAX		MIN	MAX	MIN	MAX
A	.100	.104	2.54	2.64	F	.025 BSC		0.64 BSC	
A1	.039	.043	0.99	1.09	b1	.164	.170	4.17	4.32
A2	.040	.042	1.02	1.07	c1	.007	.011	.18	.28
D	.712	.720	18.08	18.29	e	.106 BSC		2.69 BSC	
D1	.688	.692	17.48	17.58	aaa	.004		.10	
D2	.011	.019	0.28	0.48					
D3	.600	---	15.24	---					
E	.551	.559	14	14.2					
E1	.353	.357	8.97	9.07					
E2	.132	.140	3.35	3.56					
E3	.124	.132	3.15	3.35					
E4	.270	---	6.86	---					
E5	.346	.350	8.79	8.89					

© FREESCALE SEMICONDUCTOR, INC. ALL RIGHTS RESERVED.		MECHANICAL OUTLINE	PRINT VERSION NOT TO SCALE
TITLE: TO-270 4 LEAD WIDE BODY	DOCUMENT NO: 98ASA10577D		REV: D
	CASE NUMBER: 1486-03		13 AUG 2007
	STANDARD: NON-JEDEC		

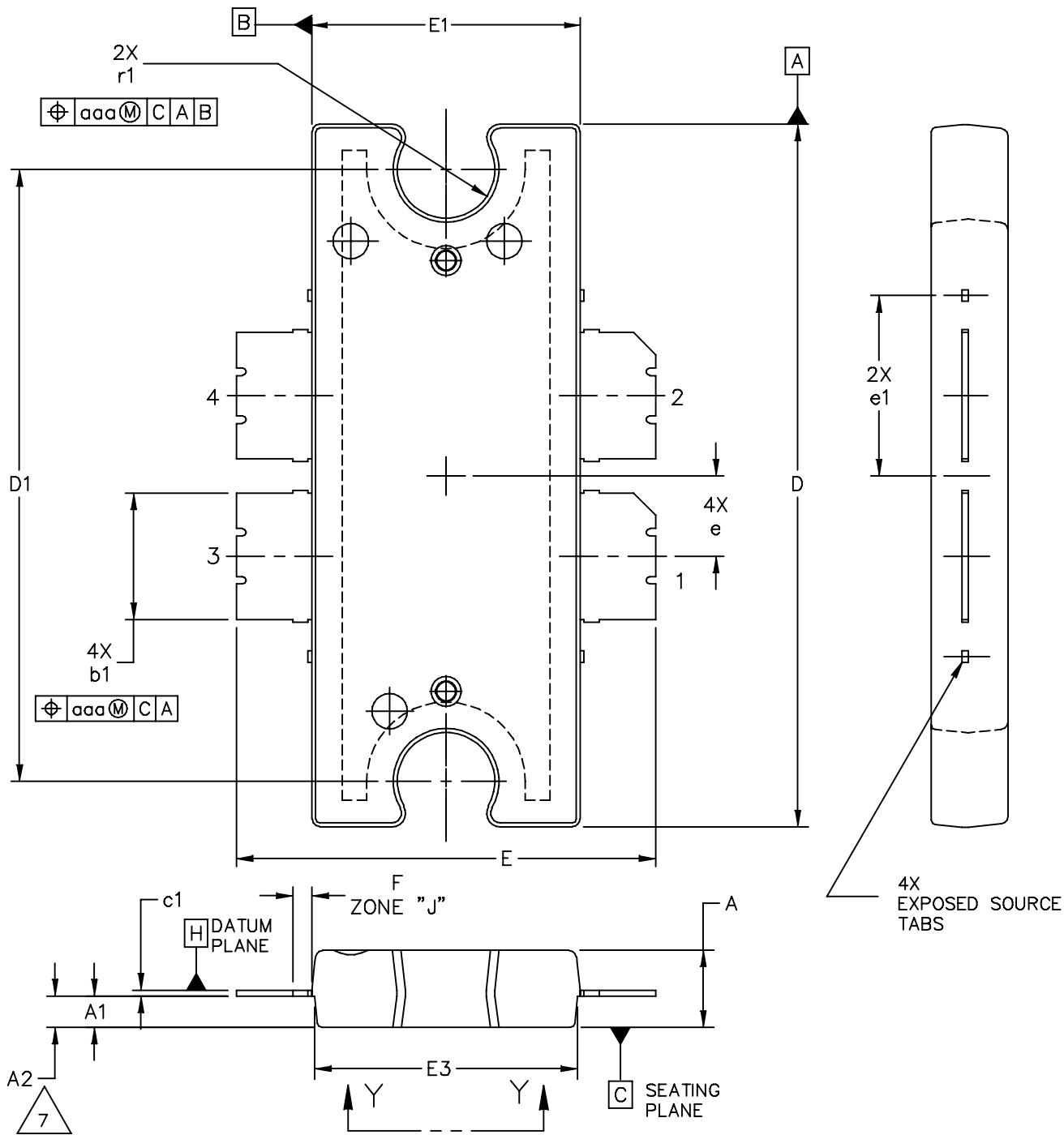

© FREESCALE SEMICONDUCTOR, INC. ALL RIGHTS RESERVED.		MECHANICAL OUTLINE		PRINT VERSION NOT TO SCALE	
TITLE: TO-272 4 LEAD, WIDE BODY			DOCUMENT NO: 98ASA10575D		REV: E
			CASE NUMBER: 1484-04		31 AUG 2007
			STANDARD: NON-JEDEC		

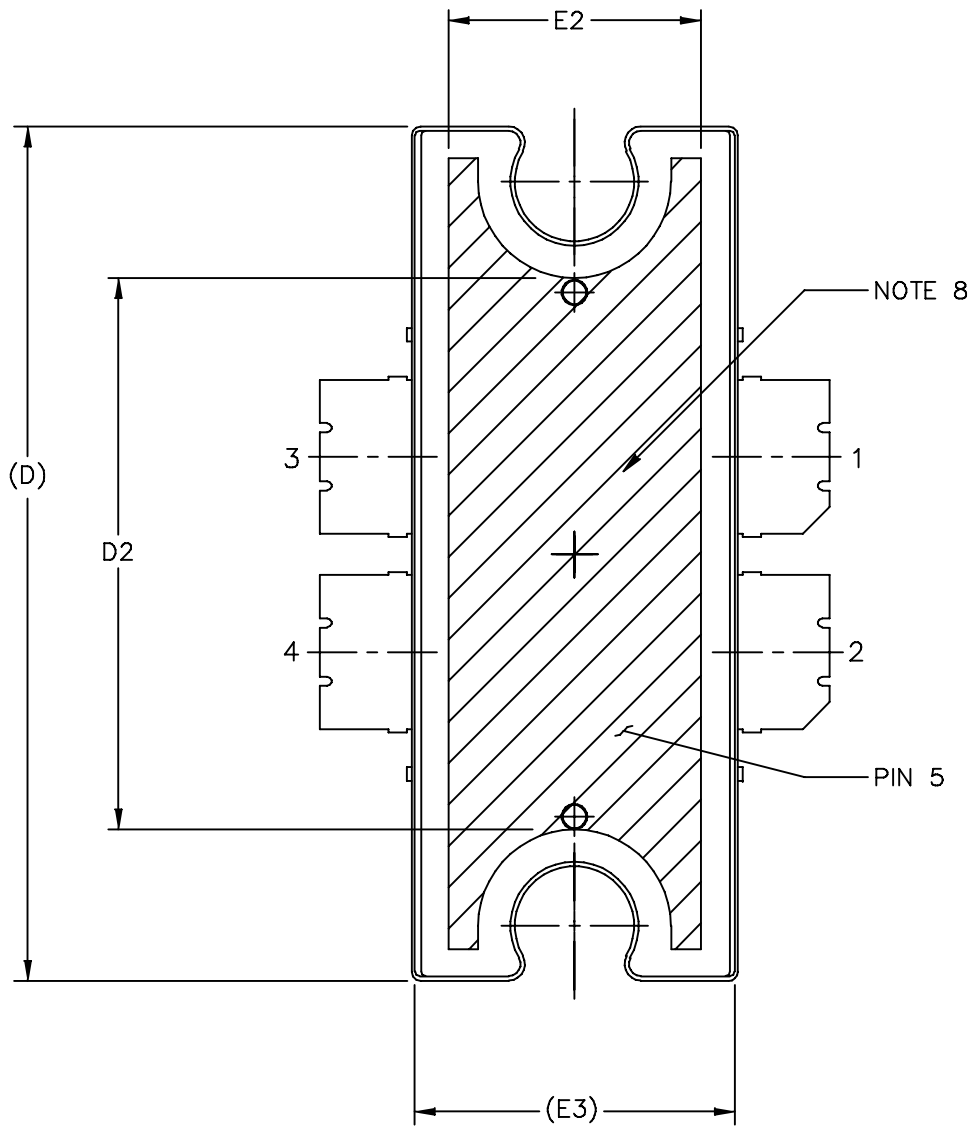

© FREESCALE SEMICONDUCTOR, INC. ALL RIGHTS RESERVED.	MECHANICAL OUTLINE	PRINT VERSION NOT TO SCALE	
TITLE: TO-272 4 LEAD, WIDE BODY	DOCUMENT NO: 98ASA10575D	REV: E	
	CASE NUMBER: 1484-04	31 AUG 2007	
	STANDARD: NON-JEDEC		

NOTES:

1. CONTROLLING DIMENSION: INCH
2. INTERPRET DIMENSIONS AND TOLERANCES PER ASME Y14.5M-1994.
3. DATUM PLANE H IS LOCATED AT THE TOP OF LEAD AND IS COINCIDENT WITH THE LEAD WHERE THE LEAD EXITS THE PLASTIC BODY AT THE TOP OF THE PARTING LINE.
4. DIMENSIONS "D" AND "E1" DO NOT INCLUDE MOLD PROTRUSION. ALLOWABLE PROTRUSION IS .006 PER SIDE. DIMENSIONS "D" AND "E1" DO INCLUDE MOLD MISMATCH AND ARE DETERMINED AT DATUM PLANE H.
5. DIMENSIONS "b1" DOES NOT INCLUDE DAMBAR PROTRUSION. ALLOWABLE DAMBAR PROTRUSION SHALL BE .005 TOTAL IN EXCESS OF THE "b1" DIMENSION AT MAXIMUM MATERIAL CONDITION.
6. DATUM A AND B TO BE DETERMINED AT DATUM PLANE H.
7. DIMENSION A2 APPLIES WITHIN ZONE "J" ONLY.
8. HATCHING REPRESENTS EXPOSED AREA OF THE HEAT SLUG. HATCHED AREA SHOWN IS ON THE SAME PLANE.

STYLE 1:

PIN 1 - DRAIN PIN 2 - DRAIN
 PIN 3 - GATE PIN 4 - GATE
 PIN 5 - SOURCE

DIM	INCH		MILLIMETER		DIM	INCH		MILLIMETER	
	MIN	MAX	MIN	MAX		MIN	MAX	MIN	MAX
A	.100	.104	2.54	2.64	b1	.164	.170	4.17	4.32
A1	.039	.043	0.99	1.09	c1	.007	.011	.18	.28
A2	.040	.042	1.02	1.07	r1	.063	.068	1.60	1.73
D	.928	.932	23.57	23.67	e	.106 BSC		2.69 BSC	
D1	.810 BSC		20.57 BSC		e1	.239 INFO ONLY		6.07 INFO ONLY	
D2	.600	---	15.24	---	aaa	.004		.10	
E	.551	.559	14	14.2					
E1	.353	.357	8.97	9.07					
E2	.270	---	6.86	---					
E3	.346	.350	8.79	8.89					
F	.025 BSC		0.64 BSC						

© FREESCALE SEMICONDUCTOR, INC. ALL RIGHTS RESERVED.		MECHANICAL OUTLINE		PRINT VERSION NOT TO SCALE	
TITLE: TO-272 4 LEAD WIDE BODY			DOCUMENT NO: 98ASA10575D		REV: E
			CASE NUMBER: 1484-04		31 AUG 2007
			STANDARD: NON-JEDEC		

Refer to the following documents to aid your design process.

Application Notes

- AN1907: Solder Reflow Attach Method for High Power RF Devices in Plastic Packages
- AN1955: Thermal Measurement Methodology of RF Power Amplifiers
- AN3263: Bolt Down Mounting Method for High Power RF Transistors and RFICs in Over-Molded Plastic Packages

Engineering Bulletins

- EB212: Using Data Sheet Impedances for RF LDMOS Devices

Software

- Electromigration MTTF Calculator
- RF High Power Model

For Software, do a Part Number search at <http://www.freescale.com>, and select the “Part Number” link. Go to the Software & Tools tab on the part’s Product Summary page to download the respective tool.

REVISION HISTORY

The following table summarizes revisions to this document.

Revision	Date	Description
0	Feb. 2007	<ul style="list-style-type: none"> • Initial Release of Data Sheet
1	Feb. 2007	<ul style="list-style-type: none"> • Added Fig. 1, Pin Connections, p. 1 • Removed footnote references listed for Operating Junction Temperature, Table 1, Maximum Ratings, p. 1 • Added Max value to Power Gain, Table 5, Functional Tests, p. 2
2	May 2007	<ul style="list-style-type: none"> • Corrected Test Circuit Component part numbers in Table 6, Component Designations and Values for C4, C19, C5, C18, C9, C12, C14, and C23, p. 3
3	Jan. 2008	<ul style="list-style-type: none"> • Increased operating frequency to 600 MHz, p. 1 • Added Case Operating Temperature limit to the Maximum Ratings table and set limit to 150°C, p. 1 • Corrected C_{ISS} test condition to indicate AC stimulus on the V_{GS} connection versus the V_{DS} connection, Dynamic Characteristics table, p. 2 • Updated PCB information to show more specific material details, Fig. 2, Test Circuit Schematic, p. 3 • Replaced Case Outline 1486-03, Issue C, with 1486-03, Issue D, p. 9-11. Added pin numbers 1 through 4 on Sheet 1. • Replaced Case Outline 1484-04, Issue D, with 1484-04, Issue E, p. 12-14. Added pin numbers 1 through 4 on Sheet 1, replacing Gate and Drain notations with Pin 1 and Pin 2 designations.
4	Dec. 2008	<ul style="list-style-type: none"> • Added Typical Performances table for 27 MHz, 450 MHz applications, p. 2 • Added Figs. 16 and 17, Test Circuit Component Layout - 27 MHz and 450 MHz, and Tables 7 and 8, Test Circuit Component Designations and Values - 27 MHz and 450 MHz, p. 9, 10 • Added Fig. 18, Series Equivalent Source and Load Impedance for 27 MHz, 450 MHz, p. 11
5	Apr. 2010	<ul style="list-style-type: none"> • Operating Junction Temperature increased from 200°C to 225°C in Maximum Ratings table, related “Continuous use at maximum temperature will affect MTTF” footnote added and changed 200°C to 225°C in Capable Plastic Package bullet, p. 1 • Added Electromigration MTTF Calculator and RF High Power Model availability to Product Software, p. 18

How to Reach Us:

Home Page:

www.freescale.com

Web Support:

<http://www.freescale.com/support>

USA/Europe or Locations Not Listed:

Freescale Semiconductor, Inc.
Technical Information Center, EL516
2100 East Elliot Road
Tempe, Arizona 85284
1-800-521-6274 or +1-480-768-2130
www.freescale.com/support

Europe, Middle East, and Africa:

Freescale Halbleiter Deutschland GmbH
Technical Information Center
Schatzbogen 7
81829 Muenchen, Germany
+44 1296 380 456 (English)
+46 8 52200080 (English)
+49 89 92103 559 (German)
+33 1 69 35 48 48 (French)
www.freescale.com/support

Japan:

Freescale Semiconductor Japan Ltd.
Headquarters
ARCO Tower 15F
1-8-1, Shimo-Meguro, Meguro-ku,
Tokyo 153-0064
Japan
0120 191014 or +81 3 5437 9125
support.japan@freescale.com

Asia/Pacific:

Freescale Semiconductor China Ltd.
Exchange Building 23F
No. 118 Jianguo Road
Chaoyang District
Beijing 100022
China
+86 10 5879 8000
support.asia@freescale.com

For Literature Requests Only:

Freescale Semiconductor Literature Distribution Center
1-800-441-2447 or +1-303-675-2140
Fax: +1-303-675-2150
LDCForFreescaleSemiconductor@hibbertgroup.com

Information in this document is provided solely to enable system and software implementers to use Freescale Semiconductor products. There are no express or implied copyright licenses granted hereunder to design or fabricate any integrated circuits or integrated circuits based on the information in this document.

Freescale Semiconductor reserves the right to make changes without further notice to any products herein. Freescale Semiconductor makes no warranty, representation or guarantee regarding the suitability of its products for any particular purpose, nor does Freescale Semiconductor assume any liability arising out of the application or use of any product or circuit, and specifically disclaims any and all liability, including without limitation consequential or incidental damages. "Typical" parameters that may be provided in Freescale Semiconductor data sheets and/or specifications can and do vary in different applications and actual performance may vary over time. All operating parameters, including "Typicals", must be validated for each customer application by customer's technical experts. Freescale Semiconductor does not convey any license under its patent rights nor the rights of others. Freescale Semiconductor products are not designed, intended, or authorized for use as components in systems intended for surgical implant into the body, or other applications intended to support or sustain life, or for any other application in which the failure of the Freescale Semiconductor product could create a situation where personal injury or death may occur. Should Buyer purchase or use Freescale Semiconductor products for any such unintended or unauthorized application, Buyer shall indemnify and hold Freescale Semiconductor and its officers, employees, subsidiaries, affiliates, and distributors harmless against all claims, costs, damages, and expenses, and reasonable attorney fees arising out of, directly or indirectly, any claim of personal injury or death associated with such unintended or unauthorized use, even if such claim alleges that Freescale Semiconductor was negligent regarding the design or manufacture of the part.

Freescale™ and the Freescale logo are trademarks of Freescale Semiconductor, Inc. All other product or service names are the property of their respective owners.

© Freescale Semiconductor, Inc. 2007-2008, 2010. All rights reserved.

X-ON Electronics

Largest Supplier of Electrical and Electronic Components

Click to view similar products for [RF MOSFET Transistors](#) category:

Click to view products by [Nexperia](#) manufacturer:

Other Similar products are found below :

[MRF492](#) [MRFE8VP8600HR5](#) [ARF1511](#) [ARF465BG](#) [BF 2030 E6814](#) [BLF861A](#) [DU1215S](#) [DU28200M](#) [UF28100M](#) [DU2820S](#)
[MHT1008NT1](#) [MMRF1014NT1](#) [MRF426](#) [ARF468AG](#) [ARF468BG](#) [MAPHST0045](#) [DU2860U](#) [MRFE6VP5300NR1](#) [BF2040E6814HTSA1](#)
[MRFE6VP5150GMR1](#) [LET9060S](#) [MRF136Y](#) [BF999E6327HTSA1](#) [SD2931-12MR](#) [BF998E6327HTSA1](#) [MRF141](#) [MRF171](#) [MRF172](#)
[MRF174](#) [SD2942](#) [QPD1020SR](#) [BF 1005S E6327](#) [MRF134](#) [MRF136](#) [MRF137](#) [MRF141G](#) [MRF151A](#) [MRF151G](#) [MRF157](#) [MRF158](#)
[MRF160](#) [MRF166C](#) [MRF171A](#) [MRF177](#) [UF2840G](#) [TGF3021-SM](#) [ARF1510](#) [ARF448BG](#) [ARF449AG](#) [ARF466BG](#)