

SIGN	DATE	DESCRIPTION	APPROVER
△	08.09	NEW PRODUCT ISSUE	nierzhenqi
△			
△			

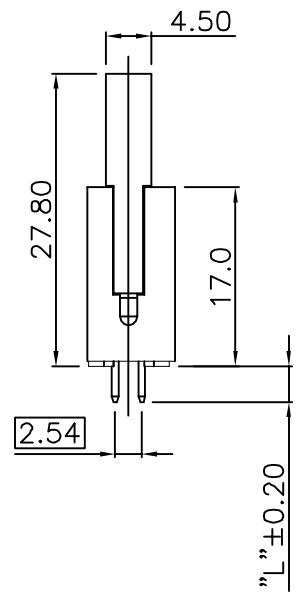
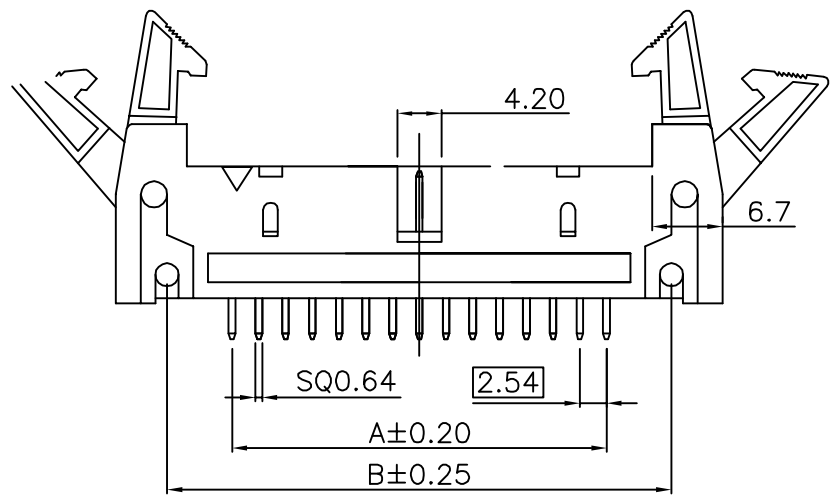

- NOTES:
- MATERIALS:
 - INSULATOR: PBT+30%GF UL94V-0, BLACK.
 - CONTACT: Copper ALLOY.
 - PLATED: CONTACT GOLD PLATED OVER Ni.
 - ELECTRICAL CHARACTERISTICS:
 - CURRENT RATING: 3 Amp.
 - CONTACT RESISTANCE: 20 mOhms Max.
 - WITHSTANDING VOLTAGE: 500V AC Min.
 - INSULATION RESISTANCE: 1000 MOhms Min.
 - Operation Temperature: -40° C~+105° C.

Part NO.

230-0*0-***-20*

Solder length
Dim "L"
1:3.4
3:4.0
4:2.9
7:4.5
Housing Color
0:Black
6:Blue
8:Grey

Plated
2:G/F
3:Au 10u"
4:Au 15u"
5:Au 30u"
9:Au 3u"
A:Au 5u"
NO. Of Positions
6~64

PIN	A±0.20	B±0.25	C±0.20	D±0.25
6	5.08	16.76	22.86	26.92
8	7.62	19.30	25.40	29.46
10	10.16	21.84	27.94	32.00
14	15.24	26.92	33.02	37.08
16	17.78	29.46	35.56	39.62
18	20.32	32.00	38.10	42.16
20	22.86	34.54	40.64	44.70
24	27.94	39.62	45.72	49.78
26	30.48	42.16	48.26	52.32
30	35.56	47.24	53.34	57.40
34	40.64	52.32	58.42	62.48
40	48.26	59.94	66.04	70.10
50	60.96	72.64	78.74	82.80
60	73.66	85.35	91.44	95.50
64	78.74	90.42	96.52	100.58

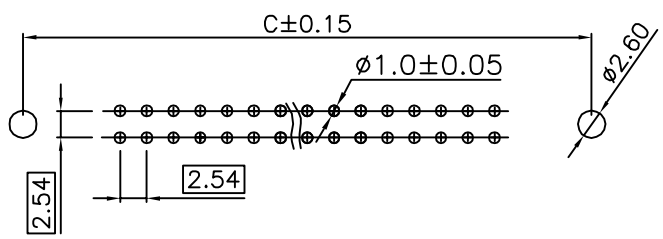
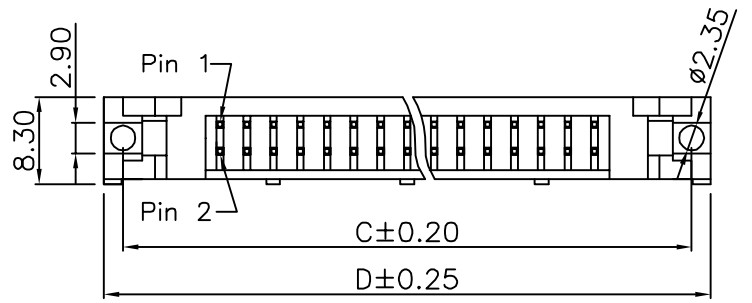

PCB LAYOUT

nexttron 正凌精密工业股份有限公司
NEXTRONICS ENGINEERING CORP

PART. NAME: xxPIN 2.54mm EJECTOR HEADER CONNECTOR				TITLE: 2.54mm EJECTOR HEADER STRAIGHT Type	
PART. NO.: SEE TABLE				DWG NAME: 230-010-834-209	
APPROVED BY	CHECKED BY	DESIGNED BY	DRAWN BY	CUSTOM NO.:	Tolerance
jeff	jeff		nierzhenqi		x. ±0.50
				UNITS: mm	x.x ±0.20
				SCALE:	x.xx ±0.10
				REVISION:	xx' ±1"

X-ON Electronics

Largest Supplier of Electrical and Electronic Components

Click to view similar products for [I/O Connectors](#) category:

Click to view products by [Nextronics](#) manufacturer:

Other Similar products are found below :

[571763P](#) [D20419-211](#) [72.250.1628.2](#) [72.250.2428.2](#) [76.350.0729.0](#) [76871-1403](#) [PCR-E36PM](#) [PCS-XE26LKA](#) [PCS-XES68MS+](#)
[G38A71314B](#) [9776-18-6](#) [1571250010](#) [157-22500-3](#) [MS3471L14-19P L/C](#) [192991-0703](#) [91-644626-35P](#) [172501-6002](#) [FCN-260C008-A/L0](#)
[FCN-260C024-AL0](#) [FCN-261Z008](#) [2000314-1](#) [200331-1](#) [PCS-E28FS+](#) [PCS-XE26SLFD+](#) [PCS-XE26SLFDT+](#) [G730VID08BDC24](#) [HDMR-](#)
[29-01-S-SM-TR](#) [HDRA-E68W1LFDTC-SL+](#) [HDR-E14MSG1+](#) [54182-0605](#) [UE86K842720321](#) [38113800006](#) [DP3AR020WQ1R200](#)
[Z4.102.0680.0](#) [500-1040](#) [500-1052](#) [500-1054](#) [ZP-4008-66L](#) [10-565995-597N](#) [10-584459-12P](#) [5554841-1](#) [SM3106F14S-7S-LC](#)
[U90B3054061110](#) [U65-E04-4020](#) [ZPF000000000097891](#) [557-262M2-06C](#) [PCS-96LFD+](#) [60-042222-02S](#) [10099439-003C-TRLF](#) [226-0348-](#)
[000](#)