

SIGN	DATE	DESCRIPTION	APPROVER
△	11.30	NEW PRODUCT ISSUE	nierzhenqi
△			
△			

NOTES:

1.MATERIAL:

Insulator:Glass filled polyester,UL94V-0.
Contact:Brass.

PLATING:

Contact Area:GOLD PLATING OVER NICKEL.

2.ELECTRICAL

VOLTAGE RATING:250V AC/DC.
CONTACT CURRENT RATING:3 AMP PER PIN.
CONTACT RESISTANCE:20 Milliohms MAXIMUM.
INSULATION RESISTANCE:1000 Megohms MINIMUM.
DIELECTRIC WITHSTANDING VOLTAGE:1000 V r.m.s.

4. ENVIRONMENTAL

TEMPERATURE TANGE: -40° C TO + 105° C.

5.60 and 64P with three key.0thers with one key.

231-012-XXX-XOX

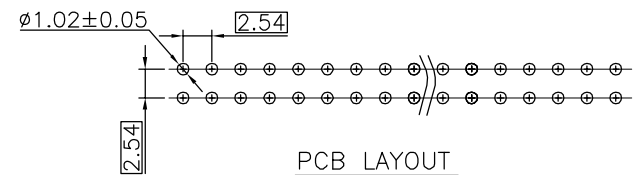
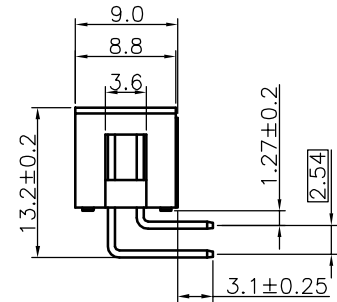
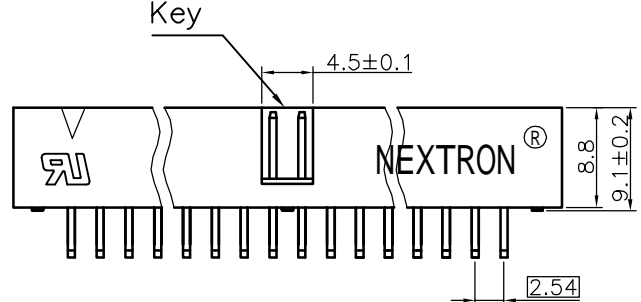
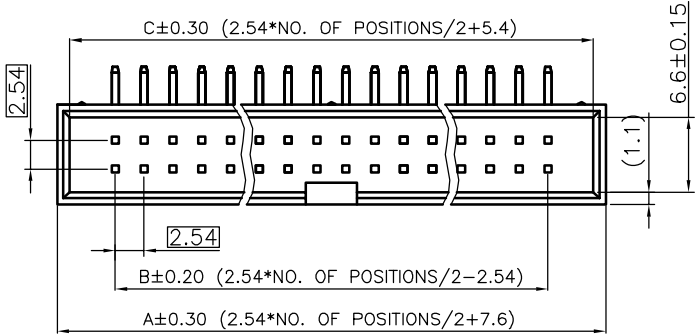
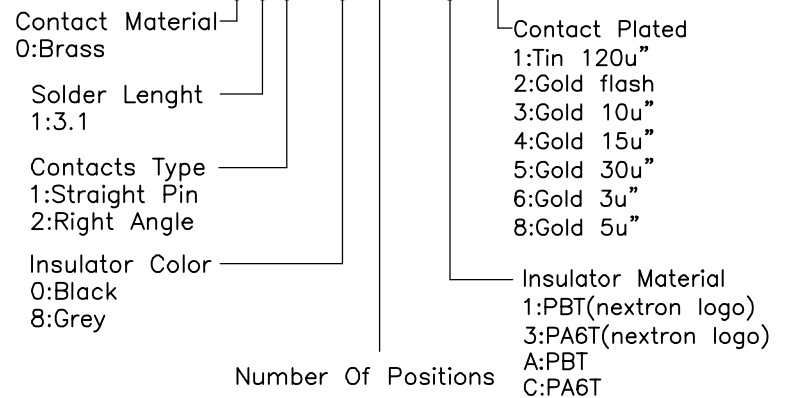

PIN	A±0.30	B±0.20	C±0.30
8	17.76	7.62	15.56
10	20.30	10.16	18.1
14	25.38	15.24	23.18
16	27.92	17.78	25.72
18	30.46	20.32	28.26
20	33.00	22.86	30.80
24	38.08	27.94	35.88
26	40.62	30.48	38.42
30	45.70	35.56	43.50
34	50.78	40.64	48.58
40	58.40	48.26	56.20
50	71.10	60.96	68.90
60	83.80	73.66	81.60
64	88.88	78.74	86.68

nextron 正凌精密工业股份有限公司
NEXTRONICS ENGINEERING CORP

PART. NAME: xxPIN 2.54mm BOX HEADER CONNECTOR				TITLE: 2.54mm BOX HEADER RIGHT ANGLE CONNECTOR			
PART. NO.:				SEE TABLE			
DWG NAME: 231-012-864-106							
APPROVED BY	CHECKED BY	DESIGNED BY	DRAWN BY	CUSTOM NO.:	Tolerance		
jeff	jeff		nierzhenqi		UNITS: mm	x.	±0.50
					SCALE:	x.xx	±0.20
					REVISION:	xx'	±0.10
							±1*

X-ON Electronics

Largest Supplier of Electrical and Electronic Components

Click to view similar products for [I/O Connectors](#) category:

Click to view products by [Nextronics](#) manufacturer:

Other Similar products are found below :

[571763P](#) [61-168618-12P](#) [D20419-211](#) [72.250.1628.2](#) [72.250.2428.2](#) [76.350.0729.0](#) [76871-1403](#) [PCR-E36PM](#) [PCS-XE26LKA](#) [PCS-XES68MS+](#) [G38A71314B](#) [9776-18-6](#) [1571250010](#) [157-22500-3](#) [MS3471L14-19P L/C](#) [192991-0703](#) [91-644626-35P](#) [172501-6002](#) [FCN-260C008-A/L0](#) [FCN-260C024-AL0](#) [FCN-261Z008](#) [2000314-1](#) [200331-1](#) [PCS-E28FS+](#) [PCS-XE26SLFD+](#) [PCS-XE26SLFDT+](#) [G730VID08BDC24](#) [HDMR-29-01-S-SM-TR](#) [HDRA-E68W1LFDTC-SL+](#) [54182-0605](#) [UE86K842720321](#) [38113800006](#) [DP3AR020WQ1R200](#) [Z4.102.0680.0](#) [500-1040](#) [500-1052](#) [500-1054](#) [ZP-4008-66L](#) [10-565995-597N](#) [10-584459-12P](#) [5554841-1](#) [SM3106F14S-7S-LC](#) [SM3106R18-18S](#) [U90B3054061110](#) [U65-E04-4020](#) [ZPF000000000097891](#) [557-262M2-06C](#) [PCS-96LFD+](#) [60-042222-02S](#) [10099439-003C-TRLF](#)