

REV.	ECN NO.	APPD	DATE
A1		Jacky	180324

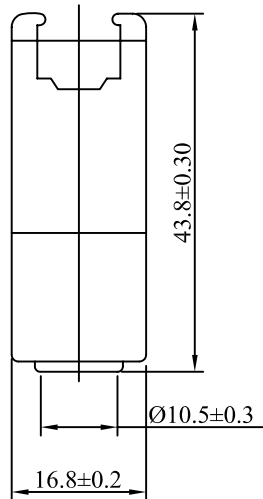
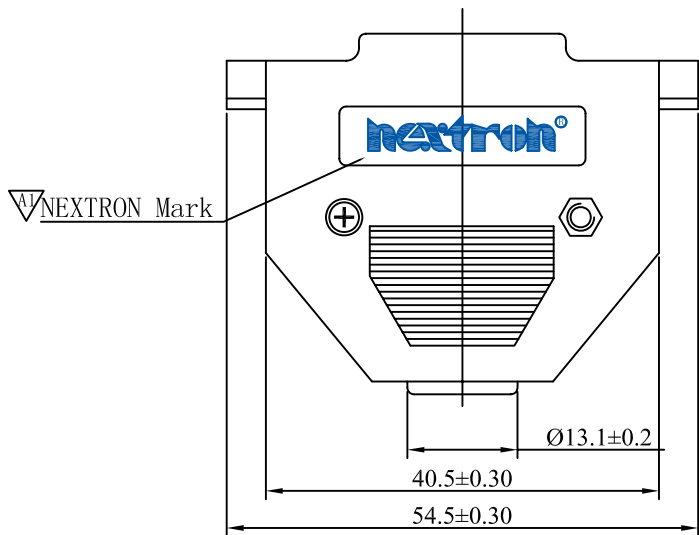

① 塑胶主体 (25PIN)

**SPECIFICATIONS:**

Current rating:NONE

Voltage rating:NONE

Contact resistance:NONE

Insulation resistance:1000M ohm MIN

Withstanding voltage:1000V AC for one minute

Operating temperature range:-25°C~+80°C(ABS)  
-25°C~+60°C(HIPS)

**MATERIAL AND FINISH**

Insulator:ABS or HIPS (UL94V-0)

Contact:Copper Alloy

Finish:Zn Plated or Cr Plated

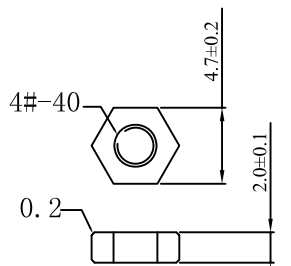

② 塑胶螺母 (通用)

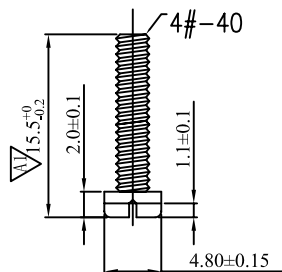

③ 塑壳螺丝 (通用)

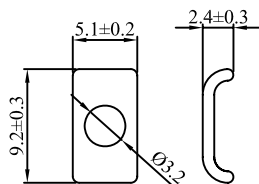

④ 卡片 (通用)

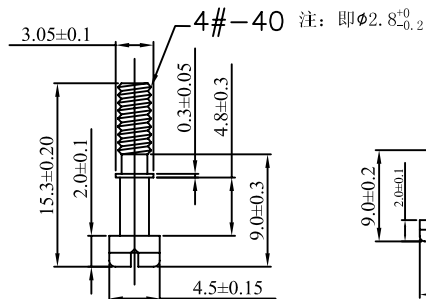

⑤ 卡片螺丝 (通用)

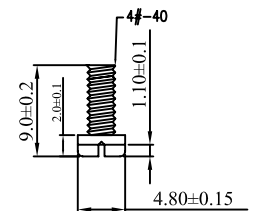

⑥ 线夹螺丝 (通用)

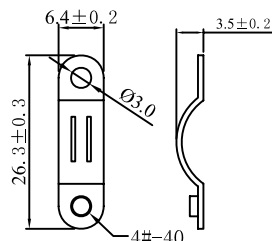

⑦ 线夹 (25Pin)

**Ordering Information**

SUB - BOX0 - 002X - XXX

Number of contacts

Code	Definition
A	9 PIN
B	15 PIN
C	25 PIN
E	37 PIN

Fitting Plated

Code	Definition
N	Ni
P	Colour Zn
Q	Blue Zn
R	Cr <sup>3+</sup>

Insulator material/Plated

Code	Definition
D	ABS No Plated
E	ABS Cr Plated
H	HIPS No Plated

Insulator color

Code	Definition
0	Black
8	Gray
L	Lvory White

Mark

Code	Definition
0	No Mark
2	Nexttron Mark

X ±0.3	UNITS	MM	NAME: D-SUB HOOD 25P
.X ±0.1	MAT'L		PART NO.: SEE TABLE
.XX ±0.05			APPD: JONSON(2018.03.24)
X° ±2°	FINISH		CHKD: JEFF(2018.03.24)
			DR: Jacky(2018.03.24)

**JJHM** 深圳市君灏精密工业有限公司  
SHENZHEN JUNHAO ENGINEERING CO., LTD

TITLE: D-SUB HOOD 25P

DWG NO.: SUB-BOC0-0020-H82

SCALE	SHEET	REV.
1:1	1/1	A1

THESE DRAWINGS AND SPECIFICATIONS ARE THE PROPERTY OF JUNHAO ENGINEERING CO.,LTD. AND SHALL NOT BE REPRODUCED, COPIED OR USED IN ANY MANNER WITHOUT THE PRIOR WRITTEN CONSENT OF JUNHAO ENGINEERING CO.,LTD.

## X-ON Electronics

Largest Supplier of Electrical and Electronic Components

*Click to view similar products for [Headers & Wire Housings](#) category:*

*Click to view products by [Nextronics](#) manufacturer:*

Other Similar products are found below :

[0015917161](#) [0022155065](#) [57102-F02-18ULF](#) [58102-G61-06LF](#) [582553-1](#) [01.001.5753.1](#) [0050291907](#) [02.125.8002.8](#) [609-3404](#) [61062-3](#)  
[CSU011177004](#) [622-0430](#) [622-3653LF](#) [63453-116](#) [636-1030](#) [636-1427](#) [636-3427](#) [636-4007](#) [641938-9](#) [65495-038](#) [65692-001LF](#) [65781-018](#)  
[65781-047](#) [65817-010LF](#) [65817-015LF](#) [67095-007LF](#) [67601157](#) [68631-112](#) [68645-018](#) [699319-000](#) [70.362.1628.0](#) [70-4210](#) [70-4226B](#) [70-](#)  
[4853B](#) [71.350.2428.0](#) [733-134](#) [733-162](#) [760-3052](#) [MHR-64-VUAL](#) [80.063.4001.1](#) [800-90-001-10-001000](#) [801-43-002-10-013000](#)  
[801-43-006-10-002000](#) [803-43-024-10-001000](#) [803-93-012-10-001000](#) [8-1437020-4](#) [819-22-004-30-001101](#) [820-22-006-30-001101](#)  
[820-22-008-30-001101](#) [821-22-002-10-001101](#)