

THIS DRAWING IS UNPUBLISHED. RELEASED FOR PUBLICATION 20
 © COPYRIGHT 20 BY - ALL RIGHTS RESERVED.

REVISIONS

P	LTR	DESCRIPTION	DATE	DWN	APVD
	A	INITIAL	28FEB2015	DW	CW
	A1	ECR-16-000601	14JAN2016	DW	CW
	A2	ECR-16-017508	12DEC2016	RL	CW
	B	ECR-18-005861	03AUG2018	YC	CW

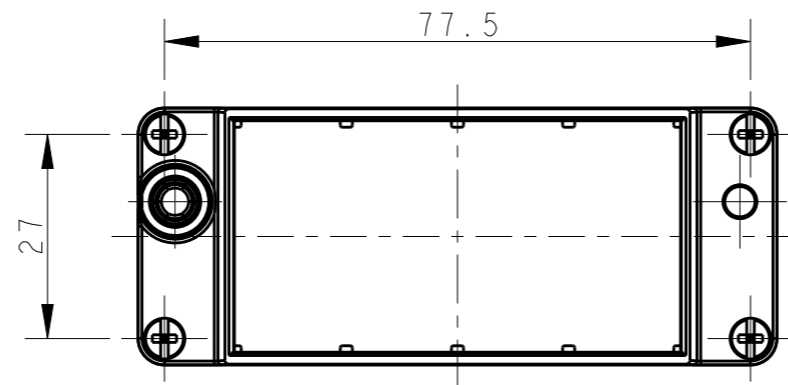
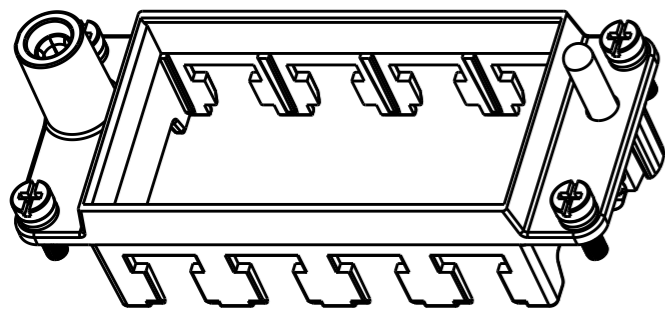

4X M3 SCREW
 RECOMMENDED TIGHTENING TORQUE 0.5Nm
 4X M3 螺丝推荐锁紧力矩为0.5Nm

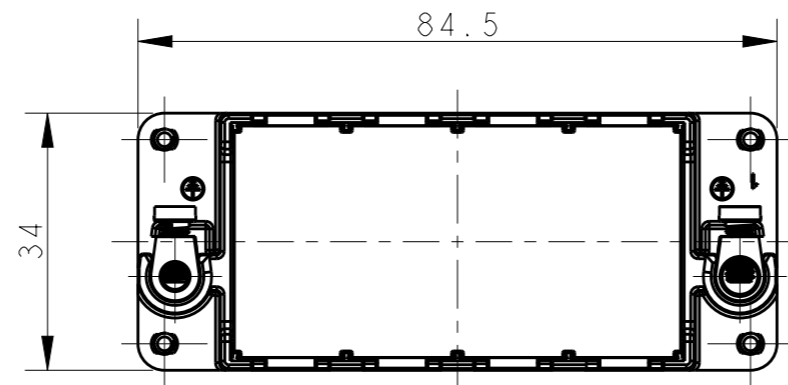
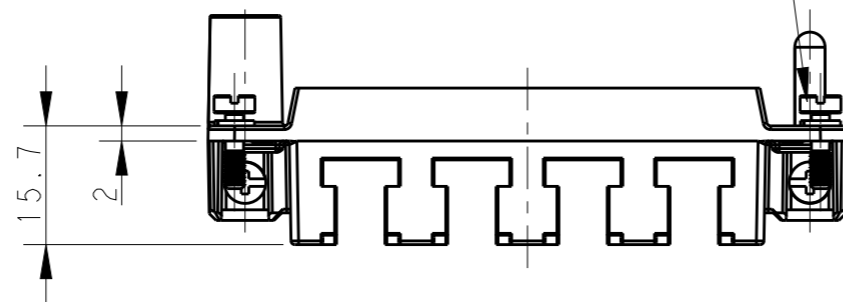
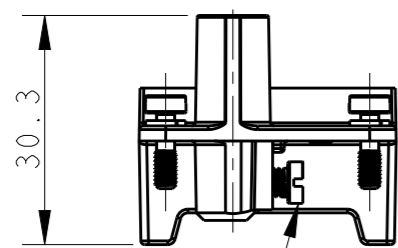

2X M4 SCREW, RECOMMENDED TIGHTENING TORQUE 1.2Nm
 2X M4 螺丝, 推荐锁紧力矩为1.2Nm

PANEL CUT FOR FRAME USE WITHOUT HOODS/ HOUSINGS

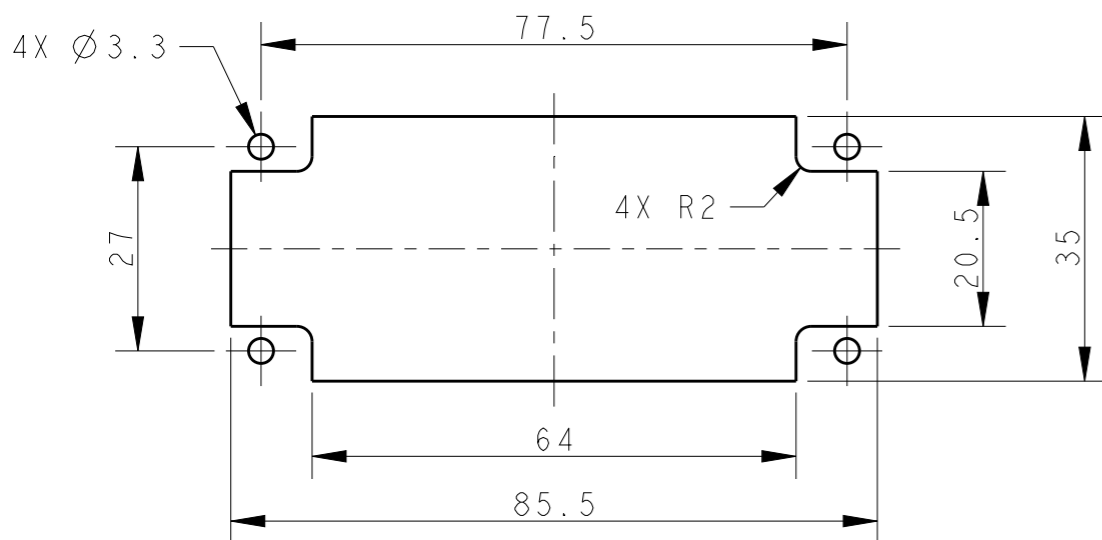

T2070164001-000 SHOWN ABOVE WITHOUT MARK
 T2070164001-000, 不带标记

NOTES:

- 1. TECHNICAL CHARACTERISTICS:
 FRAME MATERIAL: DIE CAST ZINC ALLOY
 NUMBER OF MODULES: 4
 SURFACE: ZINC PLATED
 MATING CYCLES: 500 CYCLES

注释:

- 1. 技术参数:
 框架材料: 锌合金
 模块数量: 4
 表面处理: 镀锌
 插拔次数: 500次

T2070164001-000	H16BN-T4	H16BN MODULE FRAME H16BN模块框架
T2070164101-000	H16BN-T4-M	H16BN MALE MODULE FRAME H16BN模块公框架
T2070164201-000	H16BN-T4-F	H16BN FEMALE MODULE FRAME H16BN模块母框架

PART NUMBER 料号	PART DESCRIPTION 描述
-------------------	------------------------

THIS DRAWING IS A CONTROLLED DOCUMENT.		DWN 28FEB2015 DAVID WANG	 TE Connectivity	
DIMENSIONS: mm		CHK 28FEB2015 CHRIS WANG		
TOLERANCES UNLESS OTHERWISE SPECIFIED:		APVD 28FEB2015 XIANG XU	NAME H16BN-T4	
0 PLC ±-		PRODUCT SPEC 108-137057	SIZE	
1 PLC ±-		APPLICATION SPEC 114-137057	CAGE CODE	
2 PLC ±-		WEIGHT	DRAWING NO	
3 PLC ±-		Customer Drawing	RESTRICTED TO	
4 PLC ±-			SCALE 1:1	
ANGLES ±-			SHEET 1 OF 2	
FINISH			REV B	

THIS DRAWING IS UNPUBLISHED.

RELEASED FOR PUBLICATION

20

© COPYRIGHT 20 BY -

ALL RIGHTS RESERVED.

REVISIONS

P	LTR	DESCRIPTION	DATE	DWN	APVD
-	-	SEE SHEET 1	-	-	-

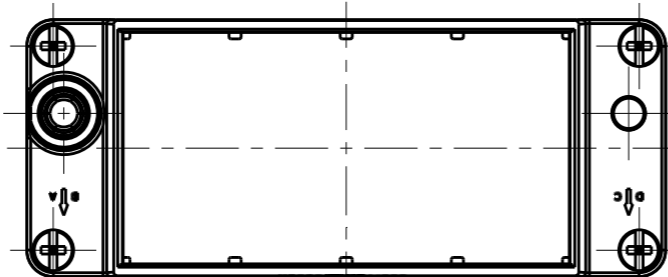
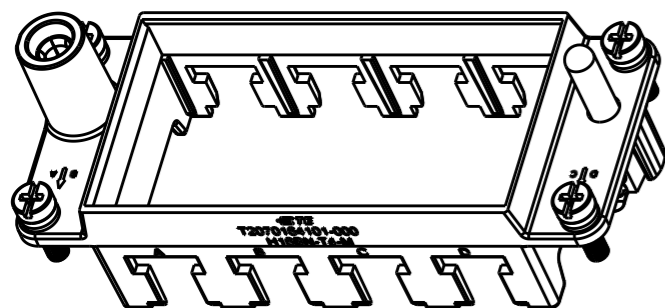

T2070164101-000, H16BN-T4-M SHOWN
 WITH MARK, ALL DIMENSIONS THE SAME TO T2070164001-000
 T2070164101-000, H16BN-T4-M, 带标记, 所有尺寸同T2070164001-000一样

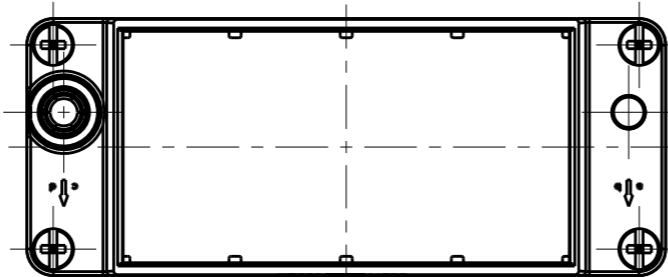
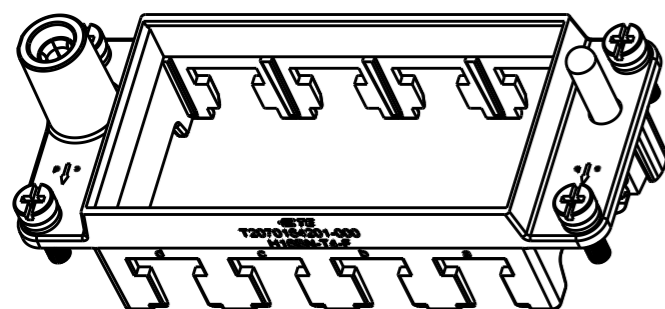
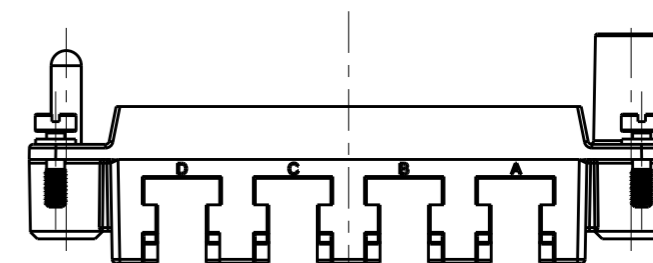
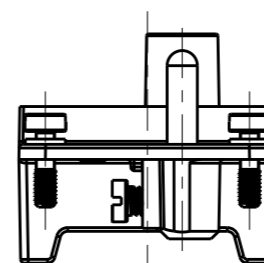
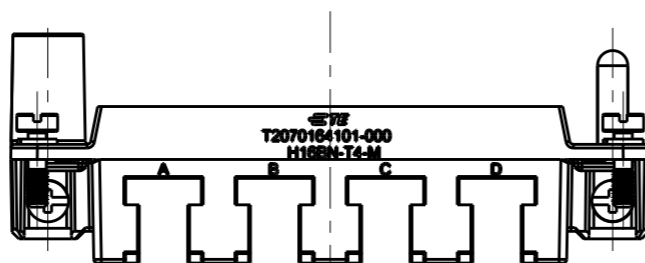

T2070164201-000, H16BN-T4-F SHOWN
 WITH MARK, ALL DIMENSIONS THE SAME TO T2070164001-000
 T2070164201-000, H16BN-T4-F, 带标记, 所有尺寸同T2070164001-000一样

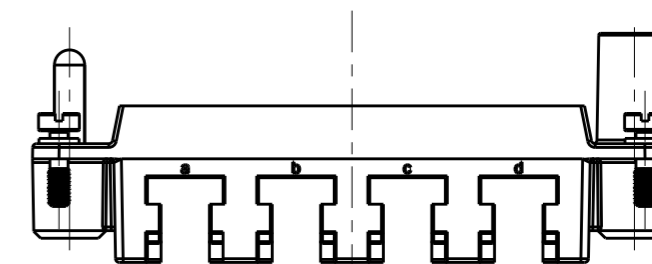
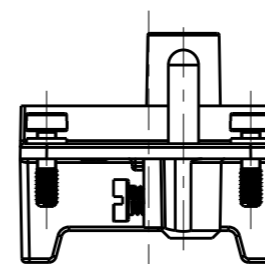
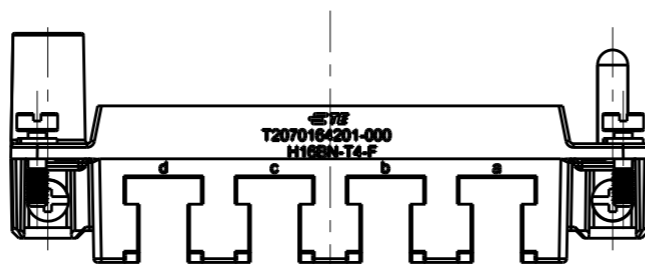

THIS DRAWING IS A CONTROLLED DOCUMENT.

DIMENSIONS:

mm

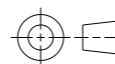

TOLERANCES UNLESS OTHERWISE SPECIFIED:

- 0 PLC ±-
- 1 PLC ±-
- 2 PLC ±-
- 3 PLC ±-
- 4 PLC ±-
- ANGLES ±-
- FINISH ±-

MATERIAL

-

DWN 28FEB2015

DAVID WANG

CHK 28FEB2015

CHRIS WANG

APVD 28FEB2015

XIANG XU

PRODUCT SPEC

108-137057

APPLICATION SPEC

114-137057

WEIGHT

-

Customer Drawing



TE Connectivity

NAME

H16BN-T4

SIZE

A3

CAGE CODE

DRAWING NO

00779 C-T2070164001000

RESTRICTED TO

-

SCALE

1:1

SHEET

2

OF

2

REV

B

X-ON Electronics

Largest Supplier of Electrical and Electronic Components

Click to view similar products for [Heavy Duty Power Connectors](#) category:

Click to view products by [TE Connectivity](#) manufacturer:

Other Similar products are found below :

[1424439](#) [1424438](#) [09330062652](#) [2-8675P1](#) [605601-1](#) [6340G1](#) [6341G1](#) [6360G1](#) [6373G1](#) [6374g2](#) [6396G1](#) [647757-1](#) [66394-4](#) [6643411-1](#)
[6646058-2](#) [6646137-1](#) [6646138-1](#) [6646348-1](#) [6646479-1](#) [6646608-1](#) [6646786-1](#) [6646940-1](#) [6651091-1](#) [6651525-1](#) [6651529-1](#) [6651778-1](#)
[6651788-1](#) [696465-1](#) [696475-1](#) [73000005059](#) [73000005349](#) [73000005642](#) [73080255059](#) [73080965046](#) [765-15-0080A](#) [765-16-0080B](#)
[789.700-44](#) [789.700-54](#) [80-1010](#) [80-9](#) [827381-1](#) [829992-1](#) [902-77-02113](#) [PL00U-301-10D10](#) [PM103MOOLOO](#) [PM16S1620S32-50](#)
[PM212MOOLOO](#) [PM309FOOLOO](#) [PM324FOOLCH](#) [PMHPAF11S03](#)