

Type CRGCQ Series

Key Features

Small size and light weight

Suitable for both wave and reflow soldering techniques

Supplied on tape

AEC-Q200 Compliant

7 different package sizes

Terminal finish matte Sn over Ni



TE Connectivity is pleased to introduce our AEC-Q200 compliant thick film Chip resistor, suitable for auto placement in volume and for most applications.

Available in seven different packages and supplied on tape and reel for automatic insertion processes. Standard values – E24 Series

Characteristics – Electrical

Type	CRGCQ0402	CRGCQ0603	CRGCQ0805	CRGCQ1206
Power Rating @ 70°C	0.0625W	0.1W	0.125W	0.25W
Jumper Rated current	1A	1A	2A	2A
Max. Jumper Current	2A	2A	5A	10A
Max. Working Voltage	50V	75V	150V	200V
Max. Overload Voltage	100V	150V	300V	400V
Dielectric Withstand V.	100V	300V	500V	500V
Jumper resistance	<50mΩ			
Temperature Range	-55°C ~ +155°C			
Ambient Temperature	70°C			

Type	CRGCQ1210	CRGCQ2010	CRGCQ2512
Power Rating @ 70°C	0.5W	0.75W	1W
Jumper Rated current	2A	2A	2A
Max. Jumper Current	10A	10A	10A
Max. Working Voltage	200V	200V	200V
Max. Overload Voltage	500V	500V	500V
Dielectric Withstand V.	500V	500V	500V
Jumper resistance	<50mΩ		
Temperature Range	-55°C ~ +155°C		
Ambient Temperature	70°C		

Power derating curve

Power rating based on continuous load operation in ambient temperature of 70°C. For resistors operated in ambient temperatures above 70°C, power rating must be derated in accordance with this curve.

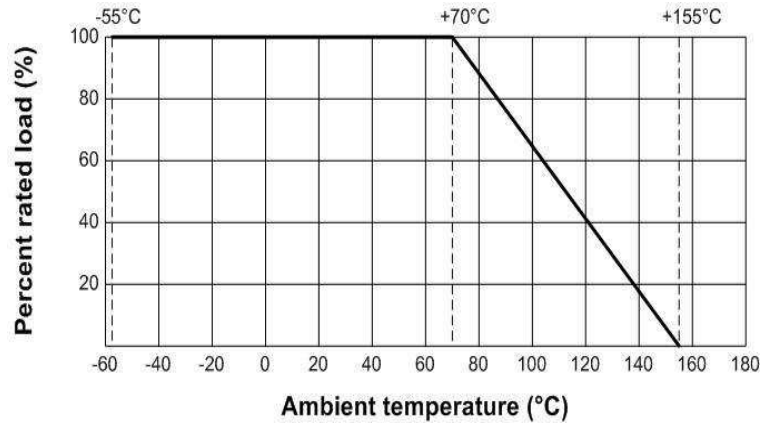

Dimensions:

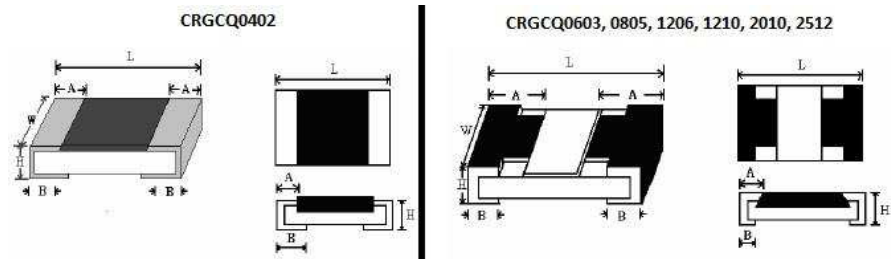

Type	Dimension (mm)				
	L	W	H	A	B
CRGCQ0402	1.00±0.10	0.50±0.05	0.35±0.05	0.20±0.10	0.25±0.10
CRGCQ0603	1.60±0.10	0.80±0.10	0.45±0.10	0.30±0.20	0.30±0.20
CRGCQ0805	2.00±0.15	1.25+0.15 -0.10	0.55±0.10	0.40±0.20	0.40±0.20
CRGCQ1206	3.10±0.15	1.55+0.15 -0.10	0.55±0.10	0.45±0.20	0.45±0.20
CRGCQ1210	3.10±0.10	2.60±0.20	0.55±0.10	0.50±0.25	0.50±0.20
CRGCQ2010	5.00±0.10	2.50±0.20	0.55±0.10	0.60±0.25	0.50±0.20
CRGCQ2512	6.35±0.10	3.20±0.20	0.55±0.10	0.60±0.25	0.50±0.20

Construction:

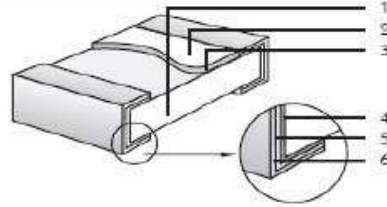

1. High purity alumina substrate
2. Protective coating
3. Resistive element
4. Termination (inner) Ni/Cr
5. Termination (between) Ni Barrier
6. Termination (outer) Sn

Power Rating and Resistance Range:

Type	Power Rating @ 70°C	Tolerance	Resistance Range	Standard Series
CRGCQ0402	0.0625W	Jumper	< 50mΩ	E24 E96 by negotiation
		±1%	10R – 1M	
		±5%	1R0 – 10M	
CRGCQ0603	0.1W	Jumper	< 50mΩ	E24 E96 by negotiation
		±1%	10R – 1M	
		±5%	1R0 – 10M	
CRGCQ0805	0.125W	Jumper	< 50mΩ	E24 E96 by negotiation
		±1%	10R – 1M	
		±5%	1R0 – 10M	
CRGCQ1206	0.25W	Jumper	< 50mΩ	E24 E96 by negotiation
		±1%	10R – 1M	
		±5%	1R0 – 10M	
CRGCQ1210	0.5W	Jumper	< 50mΩ	E24 E96 by negotiation
		±1%	10R – 1M	
		±5%	1R0 – 10M	
CRGCQ2010	0.75W	Jumper	< 50mΩ	E24 E96 by negotiation
		±1%	10R – 1M	
		±5%	1R0 – 10M	
CRGCQ2512	1W	Jumper	< 50mΩ	E24 E96 by negotiation
		±1%	10R – 1M	
		±5%	1R0 – 10M	

- Marking for E96 series 0603 size with no marking code marked as per E24 values.

Performance Specification

Characteristics	Limits	Test Methods
Load life	±1%: ±(1.0%+0.1Ω)Max. ±5%: ±(3.0%+0.1Ω)Max.	125°C, 35% power, at RCWV or Max. Working Voltage whichever less, 1,000 hours (1.5 hours "ON", 0.5hours"OFF"), Measurement at 24±2 hours after test conclusion. (MIL-STD-202 Method 108)
Temperature coefficient	1Ω ≤ R ≤ 10Ω: ±400PPM/°C 10Ω < R ≤ 100Ω: ±200PPM/°C R > 100Ω: ±100PPM/°C	Measure between -55°C ~ +125°C
Short-time overload	±1%: ±(1.0%+0.1Ω) Max ±5%: ±(2.0%+0.1Ω) Max	2.5x Rated voltage or Max. Overload Voltage whichever is lower for 5 seconds, then check the resistance.
Terminal Bending	±(1.0%+0.05Ω) Max	Bending Distance 3mm, Duration: 60s±5s, then check the resistance
Solderability	95% coverage Min.	245±3°C; 2~3s
Soldering heat	±(1.0%+0.05Ω) Max	260±5°C; 10±1s
Moisture Resistance	1%: ± (0.5%+0.1Ω) Max. 5%: ± (3.0%+0.1Ω) Max.	25°C~65°C, 90~100%RH, 2.5Hr; 65°C 90~100%RH, 3Hr; 65°C~25°C 80~100%RH, 2.5Hr, 10 cycles, Measurement at 24 hours after test conclusion (MIL-STD-202 Method 106)
Biased Humidity	1%: ± (1.0%+0.1Ω) Max. 5%: ± (3.0%+0.1Ω) Max.	10% rated power, 85°C/85%RH, 1000Hr. Measurement at 24 hours after test conclusion. (MIL-STD-202 Method 103)
Dielectric Withstand Voltage	No evidence of flashover, mechanical damage, arcing or insulation breakdown	Resistor shall be clamped in the trough of 90° metallic V-block and shall be tested at AC potential respectively specified in the given list of each product type for 60~70s.
Temperature cycling	1%: ± (0.5%+0.1Ω) Max. 5%: ± (1.0%+0.1Ω) Max	-55±3°C 30min ~normal temperature 10min-15min~155±2°C 30min~normal temperature 10min-15min1000 cycles. Measurement at 24 hours after test conclusion. (JESD22 Method JA-104)
ESD	±(1.0%+0.05Ω) Max	With the electrometer in direct contact with the discharge tip, verify the voltage setting at levels of ±500V, ±1KV, ±2KV, ±4KV, ±8KV, The electrometer reading shall be within ±10% for voltages from 500V to ≤800V. (AEC-Q200-002)
Sulfuration test	1%: ± (1.0%+0.1Ω) Max. 5%: ± (5.0%+0.1Ω) Max.	H2S 3~5PPM 50°C±2°C 91%~93% RH 1000H

Packaging Specification

Paper taping

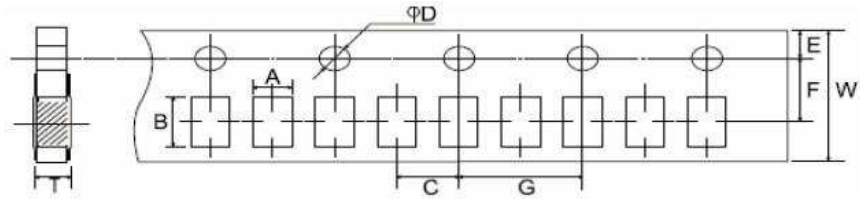

Type	A ±	B ±	C ±	∅D +0.1 -0	E ±	F ±	G ±	W ±	T ±
0402	0.65	1.15	2.0	1.5	1.75	3.5	4.0	8.0	0.45
0603	1.10	1.90	2.0	1.5	1.75	3.5	4.0	8.0	0.67
0805	1.65	2.40	2.0	1.5	1.75	3.5	4.0	8.0	0.81
1206	2.00	3.60	2.0	1.5	1.75	3.5	4.0	8.0	0.81
1210	2.80	3.50	2.0	1.5	1.75	3.5	4.0	8.0	0.75
2010	2.80	5.40	2.0	1.5	1.75	5.5	4.0	12.0	0.75

Embossed Taping

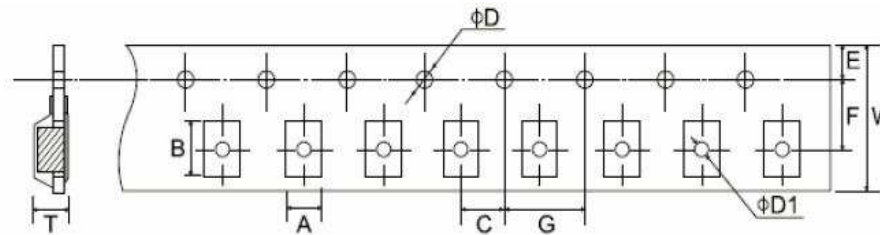

Type	A ±	B ±	C ±	∅D +0.1 -0	∅D1 +0.1 -0	E ±	F ±	G ±	W ±	T ±
2512	3.50	6.70	2.0	1.5	1.5	1.75	5.5	4.0	12.0	1.0

Peeling strength of cover tape:

Test condition: 0.1 to 0.7 N at a peel off speed of 300mm / min.

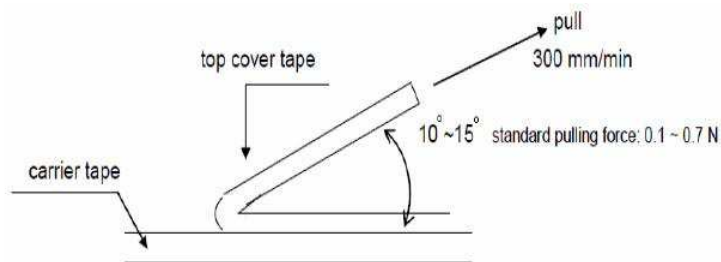

Reel Dimensions (mm):

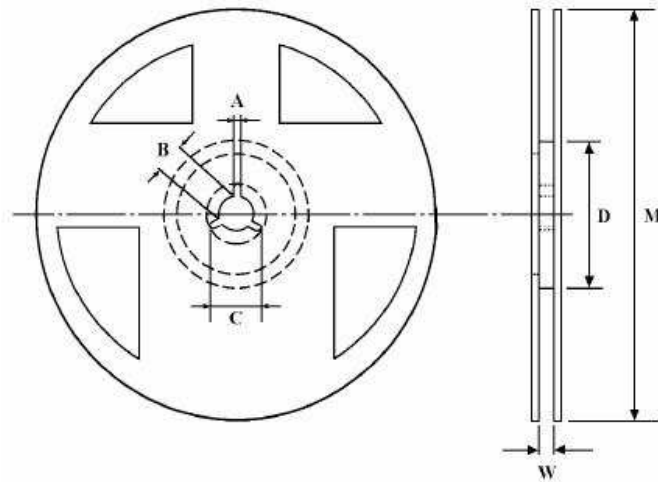

Type	Tape	Reel Qty	A ± 0.5	B ± 0.5	C ± 0.5	D ± 1	M ± 2	W ± 1
0402	Paper	10,000	2	13	21	60	178	10
0603	Paper	5,000	2	13	21	60	178	10
0805	Paper	5,000	2	13	21	60	178	10
1206	Paper	5,000	2	13	21	60	178	10
1210	Paper	5,000	2	13	21	60	178	10
2010	Paper	4,000	2	13	21	60	178	13.8
2512	Embossed	4,000	2	13	21	60	178	13.8

Label:

- A. TE Product Number
- B. Product Description
- C. Quantity
- D. Lot Number
- E. RoHS Statement

Example:

TYCO Pn	CRGCQ0603F100R	
DESC	CRGCQ 0603 100R 1%	
QTY	5000 Pcs.	PPM:
LOT	SAMPLE	
REF	RoHS 2011/65/EU	
		

Environment Related Substance

This product complies to EU RoHS directive, EU PAHs directive, EU PFOS directive and Halogen free.

Ozone layer depleting substances.

Ozone depleting substances are not used in our manufacturing process of this product.

This product is not manufactured using Chloro fluorocarbons (CFCs), Hydrochlorofluorocarbons (HCFCs), Hydrobromofluorocarbons (HBFCs) or other ozone depleting substances in any phase of the manufacturing process.

Storage Condition

The performance of these products, including the solderability, is guaranteed for a year from the date of arrival at your company, provided that they remain packed as they were when delivered and stored at a temperature of $25^{\circ}\text{C} \pm 10^{\circ}\text{C}$ and a relative humidity of $60\%RH \pm 10\%RH$, chemical and dust free atmosphere

Even within the above guarantee periods, do not store these products in the following conditions otherwise, their electrical performance and/or solderability may be deteriorated, and the packaging materials (e.g. taping materials) may be deformed or deteriorated, resulting in mounting failures.

1. In salty air or in air with a high concentration of corrosive gas, such as Cl_2 , H_2S , NH_3 , SO_2 , or NO_2
2. In direct sunlight

Solder Profile

Wave soldering condition: (2 cycles Max.)

Pre-heat : $100 \sim 120^{\circ}\text{C}$, 30 ± 5 sec.

Peak temp.: 260°C

Reflow soldering condition: (2 cycles Max.)

Pre-heat : 150 ~ 180 °C, 90 ~ 120 sec.

Suggestion solder temp.: 235 ~ 255 °C, 20 ~ 40 sec.

Peak temp.: 260 °C

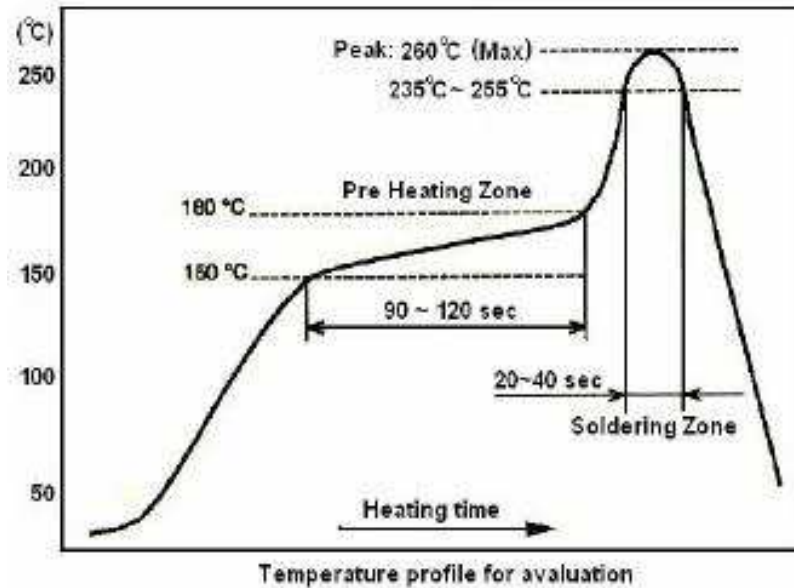

Hand Soldering condition: The Soldering iron tip should be less than 300°C and maximum contact time should be 5 seconds

How To Order

CRGCQ	0603	J	10K
Common Part	Size	Tolerance	Resistance Value
CRGCQ – AEC-Q200 compliant Thick Film Chip Resistor	0402	F - ±1% J - ±5%	1 ohm (1Ω) 1R0
	0603		1K ohm (1000Ω) 1K0
	0805		100K ohm (100000Ω)
	1206		100K
	1210		
	2010		
2512		1M ohm (1000000Ω) 1M0	

X-ON Electronics

Largest Supplier of Electrical and Electronic Components

Click to view similar products for [Thick Film Resistors - SMD category:](#)

Click to view products by [TE Connectivity manufacturer:](#)

Other Similar products are found below :

[CRCW04028R20JNEE](#) [CRCW06036K80FKEE](#) [CRG1206F1K58](#) [CRL0603-FW-R700ELF](#) [M55342K06B6E19RWL](#) [RC1005F1072CS](#)
[RC1005F471CS](#) [RC1005F4751CS](#) [RCP0603W100RGED](#) [ERJ-1GMF1R00C](#) [ERJ-1GMF1R20C](#) [ERJ-1GMF2R55C](#) [ERJ-1GMF8R66C](#)
[25121WF1003T4E](#) [25.501.3653.0](#) [290-1.0M-RC](#) [292-1.0M-RC](#) [292-2.2K-RC](#) [292-4.7K-RC](#) [25121WF4700T4E](#) [292-470K-RC](#) [302-1.0M-](#)
[RC](#) [CPG1206F10KC](#) [CRCW02011R00FXED](#) [CRCW060315K0FKEE](#) [CRCW060320K5FKEE](#) [CRG0201F10K](#) [RCP2512B100RGWB](#)
[RCWP12061K00FKS2](#) [3520510RJT](#) [352075KJT](#) [M55342K11B9E53RUL](#) [RMC16-102JT](#) [RMC1JPTE](#) [TR0603MR-075K1L](#) [5-2176094-4](#)
[35202K7JT](#) [WF06Q1000FTL](#) [ERJ-S14J4R7U](#) [CHP2512L4R30GNT](#) [WR12X1621FTL](#) [RCWP11001K00FKS3](#) [LRC-LRF3W-01-R050-](#)
[FTR1800](#) [9-2176088-6](#) [NRC06F1002TR20F](#) [CRCW02013M30FNED](#) [CRCW060343K0FKEE](#) [WR04X5360FTL](#) [RCA060345K3FKEA](#)
[LTR100JZPF33R0](#)