

**SMAJ5.0A/CA THRU SMAJ550A/CA**  
TRANSIENT VOLTAGE SUPPRESSOR DIODES



**VOLTAGE:** 5.0-550 Volts

**POWER:** 400 W

DO-214AC(SMA)

Marking and Polarity

**FEATURES**

- For surface mounted applications
- Glass passivated chip
- Low incremental surge resistance,excellent clamping capability
- 600W peak pulse power capability with a 10/1000μs wave from,repetition rate (duty cycle):0.01%
- Very fast response time
- High temperature soldering guaranteed:260°C/10 seconds, at terminals

**MECHANICAL DATA**

- **Package:** DO-214AC(SMA)
- **Epoxy UL:** 94V-0
- **Mounting position:** Any
- **Weight:** approx. 0.095 grams (0.0036 ounce)

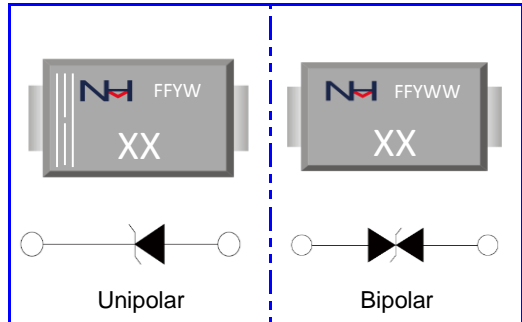

Remark:

- ①. XX=Modle Code,XX=AE/WE-TT/UT
- ②. NH=niuhan trademark
- ③. FF=Product line,According to actual changes  
YWW=Periodic code,According to actual changes
- ④. White band denotes cathode

**Maximum Ratings & Thermal Characteristics** (Ratings at 25°C ambient temperature unless otherwise specified.)

Parameter	Symbol	Value	Unit
Non-repetitive peak pulse power dissipation with a 10/1000μs waveform (NOTE 1)	<b>P<sub>PP</sub></b>	400	<b>W</b>
Peak pulse current 10/1000μs wavefrom (NOTE 1)	<b>I<sub>PP</sub></b>	See Table1	<b>A</b>
Power dissipation on infinite heatsink at TL = 75 °C	<b>P<sub>D</sub></b>	3	<b>W</b>
Peak forward surge current, 8.3 ms single half sinewave unidirectional only (NOTE 2)	<b>I<sub>FSM</sub></b>	40	<b>A</b>
Maximum instantaneous forward voltage at 50 A for unidirectional only(NOTE 3)	<b>V<sub>F</sub></b>	3.5/6.5	<b>V</b>
Junction temperature	<b>T<sub>J</sub></b>	-55~+150	<b>°C</b>
Storage temperature range	<b>T<sub>STG</sub></b>	-55~+150	<b>°C</b>
Thermal Resistance, Junction to Ambient Air	<b>R<sub>θJA</sub></b>	100	<b>°C/W</b>
Thermal Resistance, Junction to lead	<b>R<sub>θJL</sub></b>	32	

Notes: 1. Non-repetitive current pulse per Fig.5 and derated above TA= 25 °C per Fig.1;

2. Measured on 8.3 ms single half sine-wave or equivalent square wave, duty cycle = 4 pulses per minute maximum;

3. VF<3.5V for devices of VBR<200V and VF<6.5V for devices of VBR>201V.

**SMAJ5.0A/CA THRU SMAJ550A/CA**  
 TRANSIENT VOLTAGE SUPPRESSOR DIODES

**Electrical Characteristic (Rating at 25°C ambient temperature unless otherwise specified).**
**Table 1**

Part Number		Device Marking Code		Reverse Stand-off Voltage	Breakdown Voltage VBR @ I <sub>T</sub>		Test Current	Max. Clamping Voltage @ I <sub>PP</sub>	Max. Peak Pulse Current	Max. Reverse Leakage @ V <sub>RWM</sub>
UNI-POLAR	BI-POLAR	UNI	BI	V <sub>RWM</sub> (V)	Min.(V)	Max.(V)	I <sub>T</sub> (mA)	V <sub>C MAX.</sub> (V)	I <sub>PP</sub> (A)	I <sub>R</sub> ( $\mu$ A)
SMAJ5.0A	SMAJ5.0CA	AE	WE	5.0	6.40	7.00	10	9.2	43.5	800
SMAJ6.0A	SMAJ6.0CA	AG	WG	6.0	6.67	7.37	10	10.3	38.8	800
SMAJ6.5A	SMAJ6.5CA	AK	WK	6.5	7.22	7.98	10	11.2	35.7	500
SMAJ7.0A	SMAJ7.0CA	AM	WM	7.0	7.78	8.60	10	12.0	33.3	200
SMAJ7.5A	SMAJ7.5CA	AP	WP	7.5	8.33	9.21	1	12.9	31.0	100
SMAJ8.0A	SMAJ8.0CA	AR	WR	8.0	8.89	9.83	1	13.6	29.4	50
SMAJ8.5A	SMAJ8.5CA	AT	WT	8.5	9.44	10.40	1	14.4	27.8	20
SMAJ9.0A	SMAJ9.0CA	AV	WV	9.0	10.00	11.10	1	15.4	26.0	10
SMAJ10A	SMAJ10CA	AX	WX	10.0	11.10	12.30	1	17.0	23.5	5
SMAJ11A	SMAJ11CA	AZ	WZ	11.0	12.20	13.50	1	18.2	22.0	1
SMAJ12A	SMAJ12CA	BE	XE	12.0	13.30	14.70	1	19.9	20.1	1
SMAJ13A	SMAJ13CA	BG	XG	13.0	14.40	15.90	1	21.5	18.6	1
SMAJ14A	SMAJ14CA	BK	XK	14.0	15.60	17.20	1	23.2	17.2	1
SMAJ15A	SMAJ15CA	BM	XM	15.0	16.70	18.50	1	24.4	16.4	1
SMAJ16A	SMAJ16CA	BP	XP	16.0	17.80	19.70	1	26.0	15.4	1
SMAJ17A	SMAJ17CA	BR	XR	17.0	18.90	20.90	1	27.6	14.5	1
SMAJ18A	SMAJ18CA	BT	XT	18.0	20.00	22.10	1	29.2	13.7	1
SMAJ20A	SMAJ20CA	BV	XV	20.0	22.20	24.50	1	32.4	12.3	1
SMAJ22A	SMAJ22CA	BX	XX	22.0	24.40	26.90	1	35.5	11.3	1
SMAJ24A	SMAJ24CA	BZ	XZ	24.0	26.70	29.50	1	38.9	10.3	1
SMAJ26A	SMAJ26CA	CE	YE	26.0	28.90	31.90	1	42.1	9.5	1
SMAJ28A	SMAJ28CA	CG	YG	28.0	31.10	34.40	1	45.4	8.8	1
SMAJ30A	SMAJ30CA	CK	YK	30.0	33.50	36.80	1	48.4	8.3	1
SMAJ33A	SMAJ33CA	CM	YM	33.0	36.70	40.60	1	53.3	7.5	1
SMAJ36A	SMAJ36CA	CP	YP	36.0	40.00	44.20	1	58.1	6.9	1
SMAJ40A	SMAJ40CA	CR	YR	40.0	44.40	49.10	1	64.5	6.2	1
SMAJ43A	SMAJ43CA	CT	YT	43.0	47.80	52.80	1	69.4	5.8	1
SMAJ45A	SMAJ45CA	CV	YV	45.0	50.00	55.30	1	72.7	5.5	1
SMAJ48A	SMAJ48CA	CX	YX	48.0	53.30	58.90	1	77.4	5.2	1
SMAJ51A	SMAJ51CA	CZ	YZ	51.0	56.70	62.70	1	82.4	4.9	1
SMAJ54A	SMAJ54CA	RE	ZE	54.0	60.00	66.30	1	87.1	4.6	1

**SMAJ5.0A/CA THRU SMAJ550A/CA**  
 TRANSIENT VOLTAGE SUPPRESSOR DIODES

**Electrical Characteristic (Rating at 25°C ambient temperature unless otherwise specified).**
**Table 1**

Part Number		Device Marking Code		Reverse Stand-off Voltage	Breakdown Voltage VBR @ I <sub>T</sub>		Test Current	Max. Clamping Voltage @ I <sub>PP</sub>	Max. Peak Pulse Current	Max. Reverse Leakage @ V <sub>RWM</sub>
UNI-POLAR	BI-POLAR	UNI	BI	V <sub>RWM</sub> (V)	Min.(V)	Max.(V)	I <sub>T</sub> (mA)	V <sub>C MAX.</sub> (V)	I <sub>PP</sub> (A)	I <sub>R</sub> ( $\mu$ A)
SMAJ58A	SMAJ58CA	RG	ZG	58.0	64.40	71.20	1	93.6	4.3	1
SMAJ60A	SMAJ60CA	RK	ZK	60.0	66.70	73.70	1	96.8	4.1	1
SMAJ64A	SMAJ64CA	RM	ZM	64.0	71.10	78.60	1	103.0	3.9	1
SMAJ70A	SMAJ70CA	RP	ZP	70.0	77.80	86.00	1	113.0	3.5	1
SMAJ75A	SMAJ75CA	RR	ZR	75.0	83.30	92.10	1	121.0	3.3	1
SMAJ78A	SMAJ78CA	RT	ZT	78.0	86.70	95.80	1	126.0	3.2	1
SMAJ85A	SMAJ85CA	RV	ZV	85.0	94.40	104.00	1	137.0	2.9	1
SMAJ90A	SMAJ90CA	RX	ZX	90.0	100.00	111.00	1	146.0	2.7	1
SMAJ100A	SMAJ100CA	RZ	ZZ	100.0	111.00	123.00	1	162.0	2.5	1
SMAJ110A	SMAJ110CA	SE	VE	110.0	122.00	135.00	1	177.0	2.3	1
SMAJ120A	SMAJ120CA	SG	VG	120.0	133.00	147.00	1	193.0	2.1	1
SBMJ130A	SBMJ130CA	SK	VK	130.0	144.00	159.00	1	209.0	1.9	1
SMAJ150A	SMAJ150CA	SM	VM	150.0	167.00	185.00	1	243.0	1.6	1
SBMJ160A	SBMJ160CA	SP	VP	160.0	178.00	197.00	1	259.0	1.5	1
SMAJ170A	SMAJ170CA	SR	VR	170.0	189.00	209.00	1	275.0	1.5	1
SMAJ180A	SMAJ180CA	ST	VT	180.0	201.00	222.00	1	292.0	1.4	1
SMAJ190A	SMAJ190CA	SA	VA	190.0	209.00	243.00	1	308.0	1.3	1
SMAJ200A	SMAJ200CA	SV	VV	200.0	224.00	247.00	1	324.0	1.2	1
SMAJ210A	SMAJ210CA	SB	VB	210.0	231.00	268.00	1	340.0	1.2	1
SMAJ220A	SMAJ220CA	SX	VX	220.0	246.00	272.00	1	356.0	1.1	1
SMAJ250A	SMAJ250CA	SZ	VZ	250.0	279.00	309.00	1	405.0	1.0	1
SMAJ300A	SMAJ300CA	TE	UE	300.0	335.00	371.00	1	486.0	0.8	1
SMAJ350A	SMAJ350CA	TG	UG	350.0	391.00	432.00	1	567.0	0.7	1
SMAJ400A	SMAJ400CA	TK	UK	400.0	447.00	494.00	1	648.0	0.6	1
SMAJ440A	SMAJ440CA	TM	UM	440.0	492.00	543.00	1	713.0	0.6	1
SMAJ480A	SMAJ480CA	TP	UP	480.0	536.00	593.00	1	750.0	0.5	1
SMAJ520A	SMAJ520CA	TR	UR	520.0	578.00	640.00	1	762.0	0.5	1
SMAJ550A	SMAJ550CA	TT	UT	550.0	615.00	680.00	1	860.0	0.4	1

**SMAJ5.0A/CA THRU SMAJ550A/CA**  
TRANSIENT VOLTAGE SUPPRESSOR DIODES



**RATING AND CHARACTERISTIC CURVES**

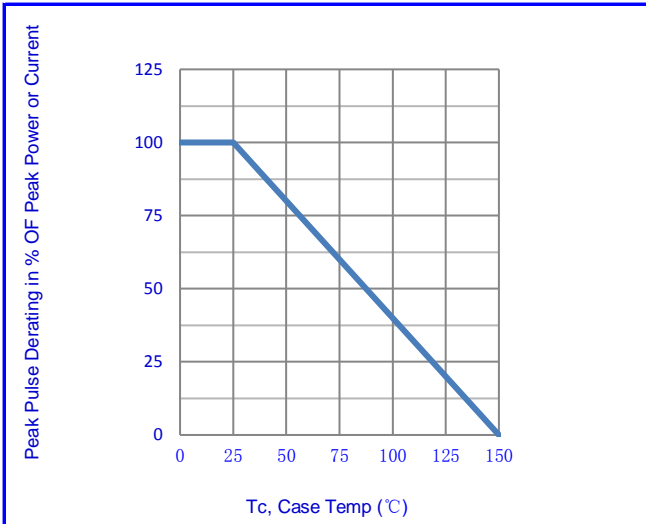

Fig.1-Pulse Derating Curve

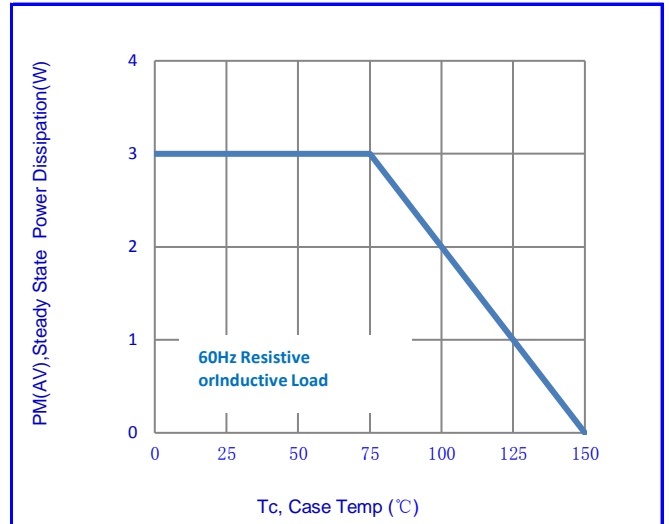

Fig.2- Steady State Power Derating Curve

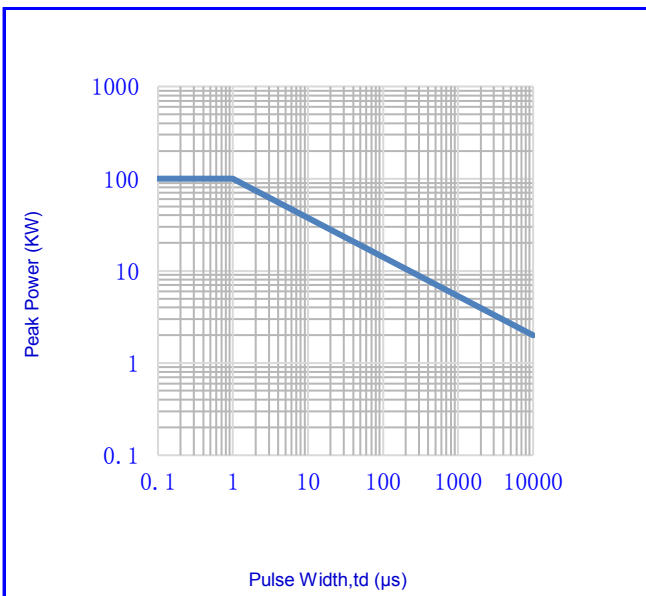

Fig.3- Peak Pulse Power Rating Curve

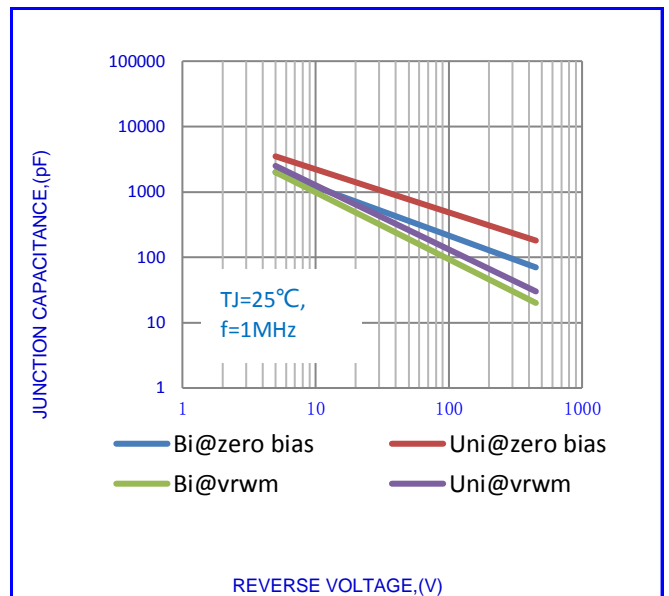

Fig.4-TYPICAL JUNCTION CAPACITANCE

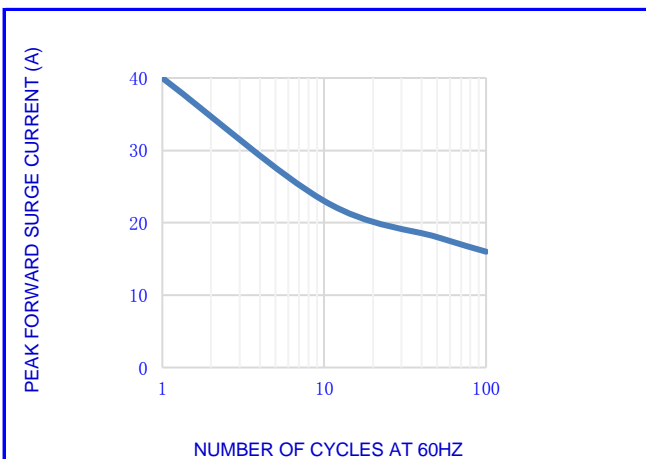

Fig.5-MAX. NON-REPETITIVE SURGE CURRENT

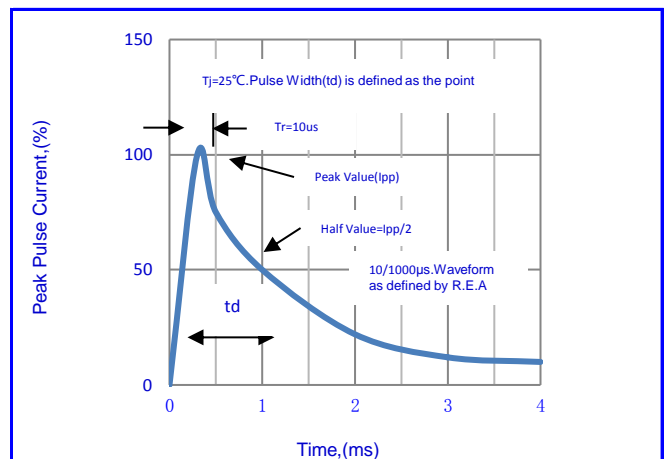

Fig.6-Pulse Waveform

**SMAJ5.0A/CA THRU SMAJ550A/CA**  
TRANSIENT VOLTAGE SUPPRESSOR DIODES



**OUTLINE DRAWINGS**

**DO-214AC(SMA)**

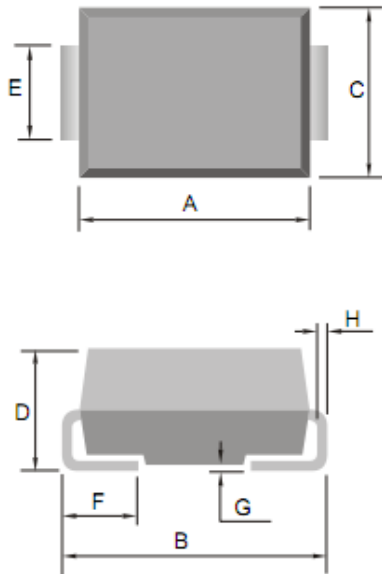

OUTLINE DIMENSIONS						
Dim.	Millimeters			Inches		
	Min.	Typ.	Max.	Min.	Typ.	Max.
A	4.000	-	4.600	0.181	-	0.157
B	4.700	-	5.280	0.185	-	0.208
C	2.400	-	2.800	0.094	-	0.110
D	1.900	-	2.400	0.075	-	0.094
E	1.300	-	1.500	0.051	-	0.059
F	0.760	-	1.520	0.030	-	0.060
G	0.100	-	0.250	0.004	-	0.010
H	0.150	-	0.305	0.006	-	0.012

**MOUNTING PAD LAYOUT**

**DO-214AC(SMA)**

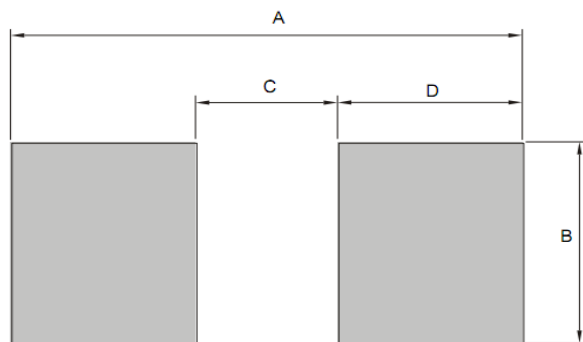

OUTLINE DIMENSIONS						
Dim.	Millimeters			Inches		
	Min.	Typ.	Max.	Min.	Typ.	Max.
A	-	5.800	-	-	0.228	-
B	-	2.060	-	-	0.081	-
C	-	1.660	-	-	0.065	-
D	-	2.070	-	-	0.082	-

**PACKING INFORMATION**

**DO-214AC(SMA)**

Package Method	Reel Size (mm)	Quantity (pcs/reel)	Inner Box Size LxWxH(mm)	Quantity (pcs/Inner Box)	Carton Size LxWxH(mm)	Quantity (pcs/carton)
Tape Reel	Φ330	5000	340x340x45	10000	360x360x470	100000

**SMAJ5.0A/CA THRU SMAJ550A/CA**  
TRANSIENT VOLTAGE SUPPRESSOR DIODES



**Recommended wave soldering condition**

Product	Peak Temperature	Soldering Time
Pb-free devices	260 +0/-5 °C	5 +1/-1 seconds

**Recommended temperature profile for IR reflow**

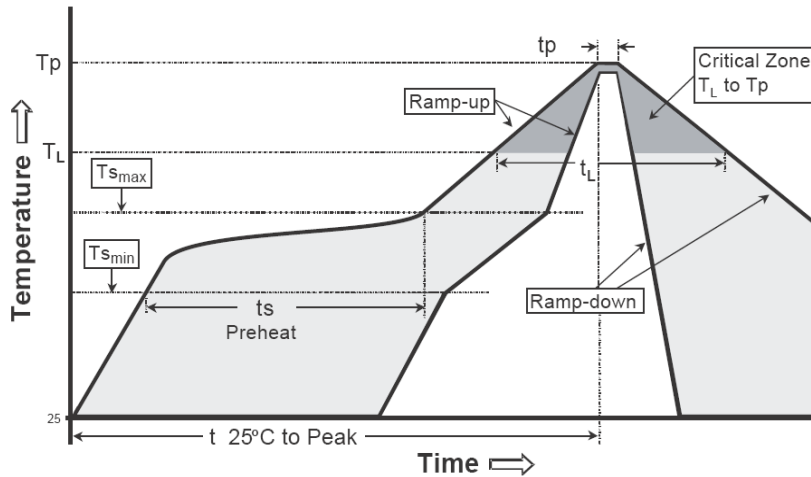

Profile feature	Sn-Pb eutectic Assembly	Pb-free Assembly
Average ramp-up rate (Tsmmax to Tp)	3°C/second max.	3°C/second max.
Preheat -Temperature Min(TS min) -Temperature Max(TS max) -Time(ts min to ts max)	100°C 150°C 60-120 seconds	150°C 200°C 60-180 seconds
Time maintained above: -Temperature (TL) - Time (tL)	183°C 60-150 seconds	217°C 60-150 seconds
Peak Temperature(TP)	240 +0/-5 °C	260 +0/-5 °C
Time within 5°C of actual peak temperature(tp)	10-30 seconds	20-40 seconds
Ramp down rate	6°C/second max.	6°C/second max.
Time 25 °C to peak temperature	6 minutes max.	8 minutes max.

Note : All temperatures refer to topside of the package, measured on the package body surface.

**SMAJ5.0A/CA THRU SMAJ550A/CA**  
TRANSIENT VOLTAGE SUPPRESSOR DIODES



**Disclaimer**

- Reproducing and modifying information of the document is prohibited without permission from niuhang electronics co., LTD.
- Niuhan Electronics co., LTD. reserves the rights to make changes of the content herein the document anytime without notification.
- Niuhan Electronics co., LTD. disclaims any and all liability arising out of the application or use of any product including damages incidentally and consequentially occurred.
- Niuhan Electronics co., LTD. does not assume any and all implied warranties, including warranties of fitness for particular purpose, non-infringement and merchantability.
- Applications shown on the herein document are examples of standard use and operation. Customers are responsible in comprehending the suitable use in particular applications. Niuhan Electronics co., LTD. makes no representation or warranty that such applications will be suitable for the specified use without further testing or modification.
- The products shown herein are not designed and authorized for equipments requiring high level of reliability or relating to human life and for any applications concerning life-saving or life-sustaining, such as medical instruments, transportation equipment, aerospace machinery et cetera. Customers using or selling these products for use in such applications do so at their own risk and agree to fully indemnify Niuhan Electronics co., LTD. for any damages resulting from such improper use or sale.
- When the appearance of the product and chip size does not change, in order to product the customer. quality, change the internal structure and the production process niuhang can not notify

## X-ON Electronics

Largest Supplier of Electrical and Electronic Components

*Click to view similar products for [ESD Suppressors / TVS Diodes](#) category:*

*Click to view products by [NH manufacturer](#):*

Other Similar products are found below :

[60KS200C](#) [D18V0L1B2LP-7B](#) [D5V0F4U5P5-7](#) [NTE4902](#) [P4KE27CA](#) [P6KE11CA](#) [P6KE8.2A](#) [SA60CA](#) [SA64CA](#) [SMBJ12CATR](#)  
[SMBJ33CATR](#) [SMBJ6.5A](#) [SMBJ8.0A](#) [ESD101-B1-02ELS E6327](#) [ESD112-B1-02EL E6327](#) [ESD7451N2T5G](#) [19180-510](#) [CPDT-5V0USP-](#)  
[HF](#) [3.0SMCJ33CA-F](#) [3.0SMCJ36A-F](#) [HSPC16701B02TP](#) [JANTX1N6126A](#) [D3V3Q1B2DLP3-7](#) [D55V0M1B2WS-7](#) [SCM1293A-04SO](#)  
[ESD200-B1-CSP0201 E6327](#) [SM12-7](#) [CEN955 W/DATA](#) [VESD12A1A-HD1-GS08](#) [CPDQC5V0-HF](#) [D1213A-01LP4-7B](#) [ESD101-B1-02EL](#)  
[E6327](#) [AOZ8808DI-03](#) [5KP15A](#) [5KP48A](#) [5KP90A](#) [ESD3V3D7-TP](#) [15KPA36A-LF](#) [P4KE56CA](#) [P4KE68A](#) [P4KE91CATR](#) [P6KE120A](#)  
[P6KE13CA](#) [P6KE43CA](#) [P6KE6.8CA](#) [P6KE8.2](#) [P6SMBJ20CA](#) [JANTX1N6072A](#) [SR2835ESKG](#) [SA90CA](#)