

UG8KB060 THRU UG8KB100

BRIDGE RECTIFIERS

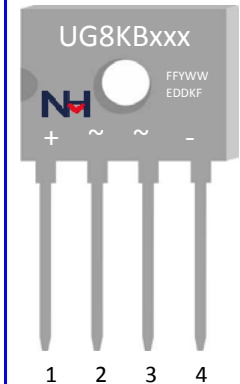

VOLTAGE	600~1000 Volts	CURRENT	8.0 Amperes	D3K	Marking & Schematic diagram
FEATURES					
<ul style="list-style-type: none"> • Glass passivated die construction • low forward voltage drop • High current capability • High surge current capability • Plastic material-UL flammability 94V-0 					
MECHANICAL DATA					
<ul style="list-style-type: none"> • Case: D3K , olded lastic • Terminals: Plated Leads Solderable per MIL-STD-202, Method 208 • Polarity: As Marked on Case • Mounting Position: Any • Lead Free: For RoHS / Lead Free Version 					
TYPICAL APPLICATIONS					
<ul style="list-style-type: none"> • For use in low voltage ,high frequency inverters ,DC/DC converters,free wheeling ,and polarity protection applications 					



PIN	DISCRIPTION
1	Output Anode(+)
2	Input Pin(-)
3	Input Pin(-)
4	Output Cathode(-)

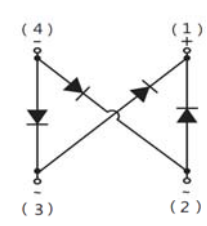

Remark:

- ①. NH=niuhang trademark
- ②. FF=Product line code,According to actual changes
YWW=Data code,According to actual changes
EDDKF=Inernal code,According to actual changes
- ③. UG8KBxxx=Modle,xxx=060,080,100
- ④. "+ ~ ~ -"=Polarity mark

Single phase,half wave,60Hz,resistive or inductive load.For capacitive load,derate current by 20%

Maximum Ratings (Ratings at 25°C ambient temperature unless otherwise specified)

Parameter	Symbol	UG8KB060	UG8KB080	UG8KB100	Unit
Maximum Repetitive Peak Reverse Voltage	V_{RRM}	600	800	1000	V
Maximum RMS Voltag	V_{RMS}	420	560	700	V
Maximum DC Blocking Voltage	V_{DC}	600	800	1000	V
Maximum Average Forward Rectified Current @ TC=100°C (see fig.1)	$I_{F(AV)}$	with heatsink without heatsink		8 1.5	A
Peak Forward Surge Current 8.3ms Single Half Sine-wave Superimposed On Rate Load (JEDEC Method)	I_{FSM}			170	A
Current Squared Time Per Diode(t<8.3ms)	$I^2 t$			119.94	A ² sec

Electrical Characterstcs (Ratings at 25°C ambient temperature unless otherwise specified)

Parameter	Symbol	UG8KB060	UG8KB080	UG8KB100	Unit
Maximum Forward Voltage Per Diode @4.0A (Note 1)	V_{FM}			1.0	V
Maximum DC Reverse Current at Rated DC Blocking Voltage (Note 2)	I_{RRM}	TC=25°C TC=125°C		5 300	uA
Typical Junction Capacitance Per Diode (Note 3)	C_J			55	pF

Thermal Characteristcs (Ratings at 25°C ambient temperature unless otherwise specified)

Parameter	Symbol	UG8KB060	UG8KB080	UG8KB100	Unit
Operating Junction Temperature Range	T_J			-55 to +150	°C
Storage Temperature Range	T_{STD}			-55 to +150	
Typical thermal resistance (Note 4)	$R_{\theta JA}$ $R_{\theta JL}$			25.0 1.5	°C/W

- Notes: 1. Pulse test: 300 μs pulse width,1% duty cycle
 2. Pulse test: pulse width ≤40ms
 3. Measured at 1 MHZ and applied reverse voltage of 4.0 VDC.
 4. Device mounted on Device mounted on 75mm x 45mm x 2.5mm Aluminum Plate Heatsink.

UG8KB060 THRU UG8KB100
BRIDGE RECTIFIERS



RATING AND CHARACTERISTIC CURVES

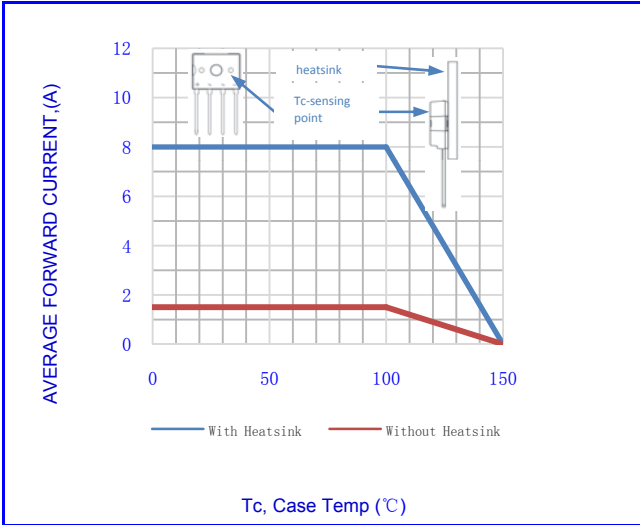

Fig.1-FORWARD CURRENT DERATING CURVE

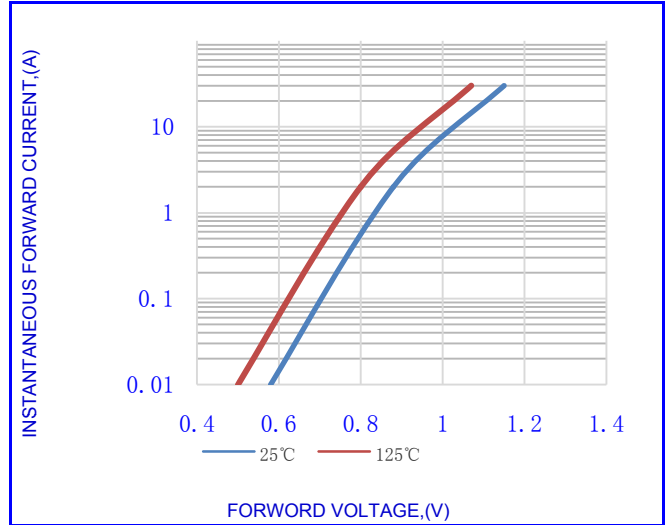

Fig.2- TYPICAL INSTANTANEOUS FORWARD

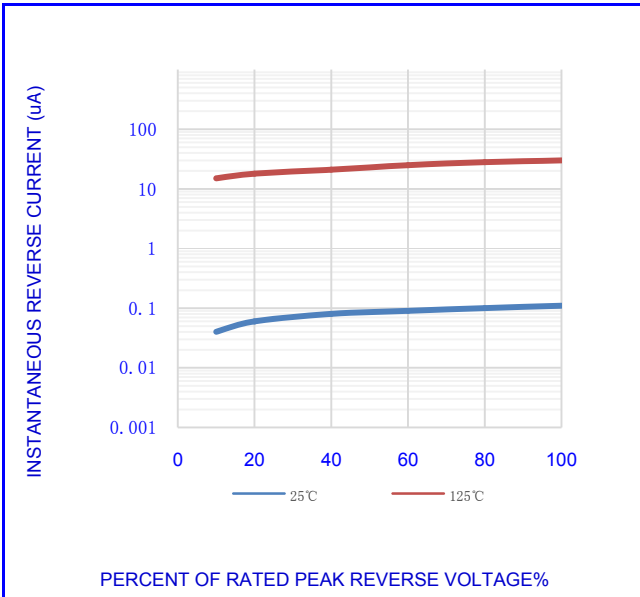

Fig.3- TYPICAL REVERSE CHARACTERISTICS

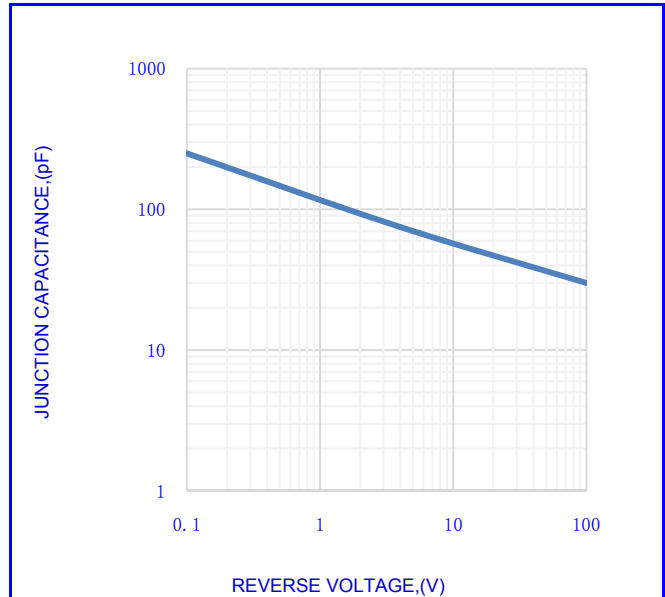

Fig.4- TYPICAL JUNCTION CAPACITANCE

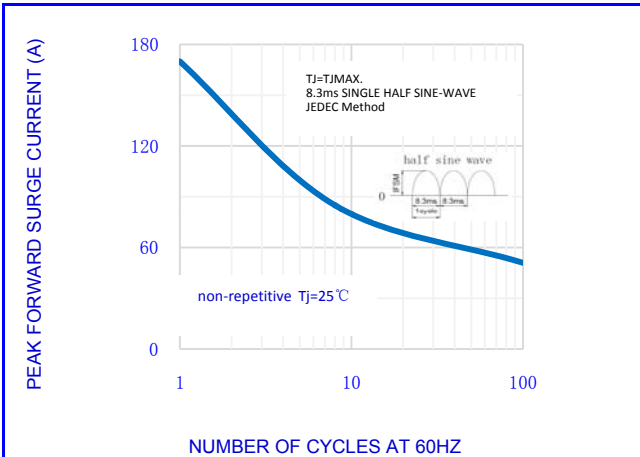

Fig.5-MAX. NON-REPETITIVE SURGE CURRENT

UG8KB060 THRU UG8KB100

BRIDGE RECTIFIERS



OUTLINE DRAWINGS

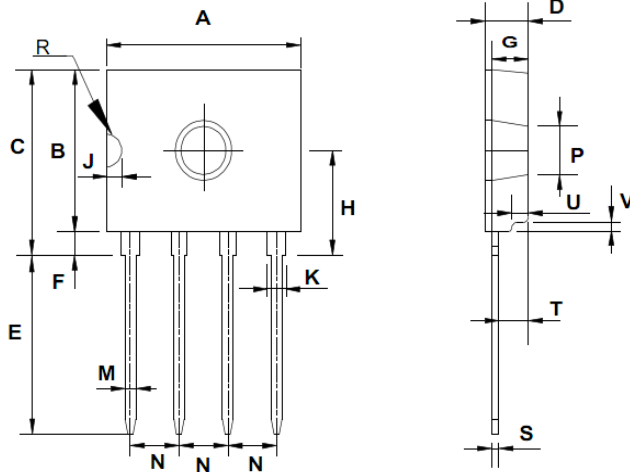

DIM	OUTLINE DIMENSIONS					
	MILLIMETERS			INCHES		
	MIN.	TYP.	MAX.	MIN.	TYP.	MAX.
A	13.50	-	14.10	0.531	-	0.555
B	10.50	-	11.10	0.413	-	0.437
C	11.70	-	12.30	0.461	-	0.484
D	2.90	-	3.30	0.114	-	0.130
E	11.70	-	12.30	0.461	-	0.484
F	1.20	-	1.40	0.047	-	0.055
G	2.40	-	2.80	0.094	-	0.110
H	6.40	-	7.00	0.252	-	0.276
J	-	1.450	-	-	0.057	-
K	1.10	-	1.50	0.043	-	0.059
M	0.66	-	0.86	0.026	-	0.034
N	3.51	-	4.11	0.138	-	0.162
P	3.10	-	3.40	0.122	-	0.134
R	-	1.450	-	-	0.057	-
S	0.40	-	0.60	0.016	-	0.024
T	1.80	-	2.40	0.071	-	0.094
U	-	0.600	-	-	0.024	-
V	1.00	-	1.40	0.039	-	0.055

D3K

Packing Information

Package	Pack	Quantity (pcs/box)	Box Size L×W×H (mm)	Carton Size L×W×H (mm)	Quantity (box/carton)
D3K	B/P	500	205×155×30	490×240×180	18

UG8KB060 THRU UG8KB100

BRIDGE RECTIFIERS



Recommended wave soldering condition

Product	Peak Temperature	Soldering Time
Pb-free devices	260 +0/-5 °C	5 +1/-1 seconds

Recommended temperature profile for IR reflow

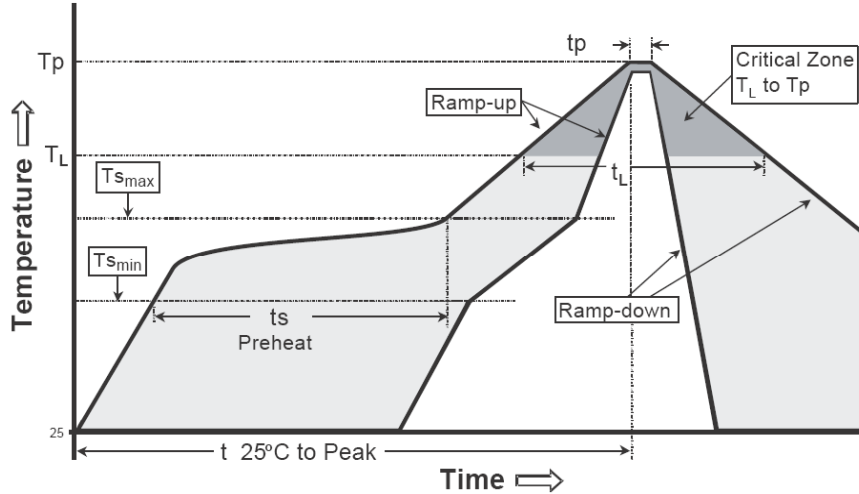

Profile feature	Sn-Pb eutectic Assembly	Pb-free Assembly
Average ramp-up rate (Tsmax to Tp)	3°C/second max.	3°C/second max.
Preheat -Temperature Min(TS min) -Temperature Max(TS max) -Time(ts min to ts max)	100°C 150°C 60-120 seconds	150°C 200°C 60-180 seconds
Time maintained above: -Temperature (TL) - Time (tL)	183°C 60-150 seconds	217°C 60-150 seconds
Peak Temperature(TP)	240 +0/-5 °C	260 +0/-5 °C
Time within 5°C of actual peak temperature(tp)	10-30 seconds	20-40 seconds
Ramp down rate	6°C/second max.	6°C/second max.
Time 25 °C to peak temperature	6 minutes max.	8 minutes max.

Note : All temperatures refer to topside of the package, measured on the package body surface.

UG8KB060 THRU UG8KB100

BRIDGE RECTIFIERS



Disclaimer

- Reproducing and modifying information of the document is prohibited without permission from niuhang Electronics co., LTD
- Niuhan Electronics co., LTD. reserves the rights to make changes of the content herein the document anytime without notification.
- Niuhan Electronics co., LTD. disclaims any and all liability arising out of the application or use of any product including damages incidentally and consequentially occurred.
- Niuhan Electronics co., LTD. does not assume any and all implied warranties, including warranties of fitness for particular purpose, non-infringement and merchantability.
- Applications shown on the herein document are examples of standard use and operation. Customers are responsible in comprehending the suitable use in particular applications. Niuhan Electronics co., LTD. makes no representation or warranty that such applications will be suitable for the specified use without further testing or modification.
- The products shown herein are not designed and authorized for equipments requiring high level of reliability or relating to human life and for any applications concerning life-saving or life-sustaining, such as medical instruments, transportation equipment, aerospace machinery et cetera. Customers using or selling these products for use in such applications do so at their own risk and agree to fully indemnify Niuhan Electronics co., LTD. for any damages resulting from such improper use or sale.
- When the appearance of the product and chip size does not change, in order to product the customer quality, change the internal structure and the production process Niuhan can not notify

X-ON Electronics

Largest Supplier of Electrical and Electronic Components

Click to view similar products for [Bridge Rectifiers](#) category:

Click to view products by [NH manufacturer](#):

Other Similar products are found below :

[MB252](#) [MB356G](#) [MB358G](#) [GBJ1504-BP](#) [GBU10B-BP](#) [GBU15K-BP](#) [GBU4A-BP](#) [GBU4D-BP](#) [DB101-BP](#) [DF01](#) [DF10SA-E345](#) [KBPC50-10S](#) [RS405GL-BP](#) [GBJ1502-BP](#) [GBU6M](#) [TB102M](#) [MB1510](#) [MB86](#) [TL401G](#) [MDA920A2](#) [TU602](#) [TU810](#) [MP5010W-BP](#) [MP501W-BP](#) [MP502-BP](#) [KBPC25-02](#) [VBO160-12NO7](#) [VS-110MT120KPBF](#) [VS-60MT80KPBF](#) [DB105-BP](#) [DF1510S](#) [VS-40MT160PAPBF](#) [GBU4G-BP](#) [GSIB15A80-E3/45](#) [DB104-BP](#) [D3SB60](#) [TB354](#) [GBJ2504-BP](#) [26MB100A](#) [B1S-G](#) [VS-40MT160KPBF](#) [VUO162-16NO7](#) [ABS10-G](#) [GBU6B-BP](#) [GBJ1508-BP](#) [BR5010-G](#) [ABS6-G](#) [B125C800G-E4/51](#) [MSB15MH-13](#) [LBS10-13](#)