

Surface Mount Aluminum Electrolytic Capacitors NACX Series

FEATURES

- CYLINDRICAL V-CHIP CONSTRUCTION
- VERY LOW IMPEDANCE AT 100KHz
- WIDE TEMPERATURE RANGE (-55 +105°C)
- MAXIMUM 5.5mm HEIGHT
- ANTI-SOLVENT (2 MINUTES)
- DESIGNED FOR REFLOW SOLDERING
- **MEETS THE REQUIREMENTS OF AEC-Q200***

*Contact NIC for supporting test data

**RoHS
Compliant**

includes all homogeneous materials

*See Part Number System for Details



CHARACTERISTICS

Rated Voltage Range		6.3 ~ 63V						
Rated Capacitance Range		1.0 ~ 150μF						
Operating Temperature Range		-55 ~ +105°C						
Capacitance Tolerance		±20% (M), ±10% (K)*						
Max. Leakage Current After 2 Minutes at 20°C		0.01CV or 3μA whichever is greater						
Surge Voltage and Max. Tan δ	W.V. (Vdc)	6.3	10	16	25	35	50	63
	S.V.(Vdc)	8	13	20	32	44	63	79
	Tan δ	0.24	0.20	0.16	0.14	0.12	0.12	0.12
Low Temperature Stability (Impedance Ratio @ 120Hz)	Z-25°C/Z+20°C	3	2	2	2	2	2	2
	Z-55°C/Z+20°C	5	4	4	3	3	3	3
High Temperature Load Life at 105°C and Rated Working Voltage 1,000 hours	Capacitance Change	Within ±25% of initial measured value						
	Tan δ	Less than 200% of specified value						
	Leakage Current	Less than the specified value						

* Optional ± 10% (K) Tolerance available on most values. Contact factory for availability.

STANDARD PRODUCT AND SIZE DφxL (mm)

Cap. (μF)	Code	Working Voltage (Vdc)						
		6.3	10	16	25	35	50	63
1.0	1R0	-	-	-	-	4x5.5	4x5.5	4x5.5
2.2	2R2	-	-	-	-	4x5.5	4x5.5	4x5.5
3.3	3R3	-	-	-	-	4x5.5	4x5.5	5x5.5
4.7	4R7	-	-	-	4x5.5	4x5.5	5x5.5	5x5.5
10	100	-	-	4x5.5	5x5.5	5x5.5	6.3x5.5	6.3x5.5
22	220	4x5.5	5x5.5	5x5.5	6.3x5.5	6.3x5.5	-	-
33	330	5x5.5	5x5.5	6.3x5.5	6.3x5.5	-	-	-
47	470	5x5.5	6.3x5.5	6.3x5.5	6.3x5.5	-	-	-
100	101	6.3x5.5	6.3x5.5	6.3x5.5	-	-	-	-
220	221	6.3x5.5	-	-	-	-	-	-

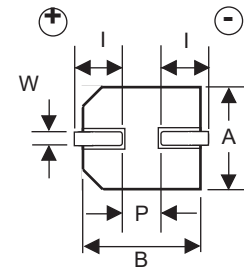
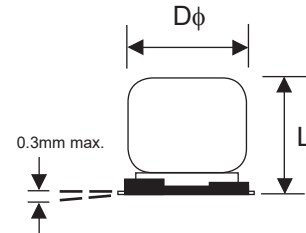

DIMENSIONS (mm)

Case Size	Dφ±0.5	L max.	A/B±0.2	l ± 0.2	W	P±0.2
4x5.5	4.0	5.5	4.3	1.8	0.5 ~ 0.8	1.0
5x5.5	5.0	5.5	5.3	2.1	0.5 ~ 0.8	1.4
6.3x5.5	6.3	5.5	6.6	2.5	0.5 ~ 0.8	2.2

PART NUMBER SYSTEM

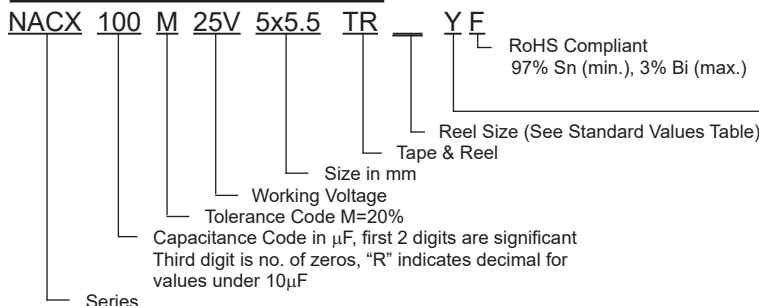

Optional: Suitable for automotive equipment, sourced to special production and inspection at IATF-16949 certified production site



Surface Mount Aluminum Electrolytic Capacitors NACX Series

STANDARD VALUES, CASE SIZES AND SPECIFICATIONS

NIC Part Number	Cap. (μF)	W.V. (Vdc)	Dissipation Factor (Tan δ)	Max. Ripple Current (mA) +105°C/100kHz	Max. Z (Ω) +20°C/100kHz	Load Life Hours @ +105°C
NACX220M6.3V4x5.5TR_F	22	6.3	0.24	68	2.3	1,000
NACX330M6.3V5x5.5TR13F	33		0.24	105	1.1	1,000
NACX470M6.3V5x5.5TR13F	47		0.24	105	1.1	1,000
NACX101M6.3V6.3x5.5TR13F	100		0.24	155	0.6	1,000
NACX221M6.3V6.3x5.5TR13F	220		0.24	155	0.6	1,000
NACX220M10V5x5.5TR13F	22	10	0.20	105	1.1	1,000
NACX330M10V5x5.5TR13F	33		0.20	105	1.1	1,000
NACX470M10V6.3x5.5TR13F	47		0.20	155	0.6	1,000
NACX101M10V6.3x5.5TR13F	100		0.20	155	0.6	1,000
NACX100M16V4x5.5TR_F	10	16	0.16	68	2.3	1,000
NACX220M16V5x5.5TR13F	22		0.16	105	1.1	1,000
NACX330M16V6.3x5.5TR13F	33		0.16	155	0.6	1,000
NACX470M16V6.3x5.5TR13F	47		0.16	155	0.6	1,000
NACX101M16V6.3x5.5TR13F	100		0.16	155	0.6	1,000
NACX4R7M25V4x5.5TR_F	4.7	25	0.14	68	2.3	1,000
NACX100M25V5x5.5TR13F	10		0.14	105	1.1	1,000
NACX220M25V6.3x5.5TR13F	22		0.14	155	0.6	1,000
NACX330M25V6.3x5.5TR13F	33		0.14	155	0.6	1,000
NACX470M25V6.3x5.5TR13F	47		0.14	155	0.6	1,000
NACX1R0M35V4x5.5TR_F	1.0	35	0.12	68	3.1	1,000
NACX2R2M35V4x5.5TR_F	2.2		0.12	68	2.9	1,000
NACX3R3M35V4x5.5TR_F	3.3		0.12	68	2.7	1,000
NACX4R7M35V4x5.5TR_F	4.7		0.12	68	2.3	1,000
NACX100M35V5x5.5TR13F	10		0.12	105	1.1	1,000
NACX220M35V6.3x5.5TR13F	22	50	0.12	155	0.6	1,000
NACX1R0M50V4x5.5TR13F	1.0		0.12	37	7.4	1,000
NACX2R2M50V4x5.5TR_F	2.2		0.12	45	6.6	1,000
NACX3R3M50V4x5.5TR_F	3.3		0.12	52	5.4	1,000
NACX4R7M50V5x5.5TR13F	4.7		0.12	75	2.9	1,000
NACX100M50V6.3x5.5TR13F	10	0.12	120	1.3	1,000	
NACX1R0M63V4x5.5TR_F	1.0	63	0.12	20	8.0	1,000
NACX2R2M63V4x5.5TR_F	2.2		0.12	24	8.0	1,000
NACX3R3M63V5x5.5TR13F	3.3		0.12	40	3.5	1,000
NACX4R7M63V5x5.5TR13F	4.7		0.12	40	3.5	1,000
NACX100M63V6.3x5.5TR13F	10		0.12	65	1.6	1,000

Part Number Suffix Where __: Preferred (15" reel) = 15, Legacy (13" reel) = 13 (check with NIC for availability)

For Automotive Equipment, see part number system

RIPPLE CURRENT FREQUENCY CORRECTION FACTORS

Capacitance (μF)	Frequency			
	100Hz ≤ F < 1KHz	1KHz ≤ F < 10KHz	10KHz ≤ F < 100KHz	100KHz ≤ F
C ≤ 1.0	0.70	0.55	0.85	1.00
1 < C ≤ 4.7	0.25	0.60	0.90	1.00
4.7 < C ≤ 47	0.45	0.75	0.92	1.00
47 < C	0.60	0.85	0.92	1.00

RECOMMENDED LAND PATTERN DIMENSIONS (mm)

Case Size	a	b	c
4 φ	1.0	2.6	1.8
5 φ	1.4	3.0	1.8
6.3 φ	2.1	3.5	1.8

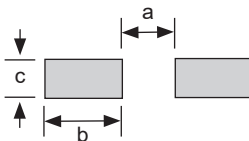

PRECAUTIONS

Please review the notes on correct use, safety and precautions found at <https://www.niccomp.com/resource/files/aluminum/AlumApplInfoCautions.pdf>
If in doubt or uncertainty, please review your specific application - process details with NIC's technical support personnel: tpmg@niccomp.com

Review & Compare Reflow Soldering Heat Limits
V-chip SMT Aluminum Electrolytic Capacitors
www.niccomp.com/RSL



CARRIER TAPE

Case Size	A ±0.2	B ±0.2	C ±0.3	D ±0.1	P ±0.1	T ±0.2
4 x 5.5	4.7	4.7	12.0	5.5	8.0	5.8
5 x 5.5	5.7	5.7	12.0	5.5	12.0	5.8
6.3 x 5.5	7.0	7.0	16.0	7.5	12.0	5.8

TAPING SPECIFICATIONS (mm)

- Both Leader and Trailer tape: Minimum 40mm (1.57") empty carrier tape pockets.
- Leader tape: Approximately 20cm of cover tape at leader.
- Connection: Maximum 3 connections (slices) per reel.

CARRIER

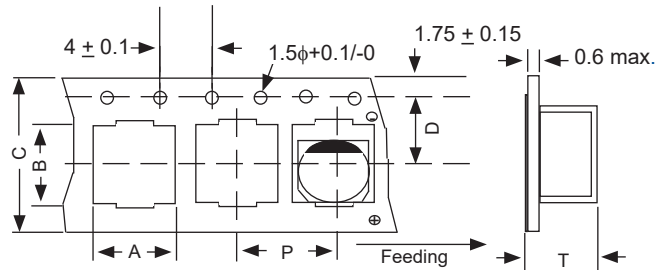

Surface Mount Aluminum Electrolytic Capacitors NACX Series

Preferred V-Chip 380mm Reels (TR15 suffix)

Dimensions (mm)

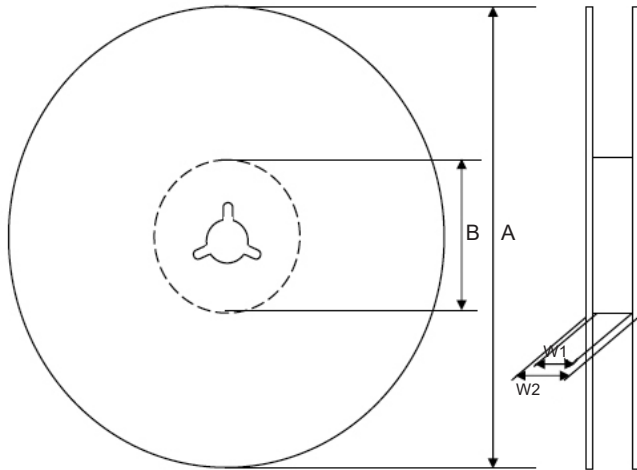

Case Size	Tape Width	W1	W2
4x5.5, 5x5.5	12.0	12.5 ~ 14.0	15.5 ~ 20.0
6.3x5.5	16.0	16.5 ~ 18.0	19.5 ~ 24.0

Case Size	Tape Width	A	B	C	D	E
4x5.5, 5x5.5	12.0	$\phi 380$	$\phi 80 \sim 105$	$\phi 13$	$\phi 21$	2.0
6.3x5.5	16.0	± 2		± 0.5	± 1.0	± 0.5

Color
Black or Blue

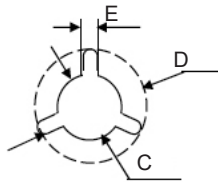

Optional V-Chip 13" (330mm) Reels (TR13 suffix)

Dimensions (mm)

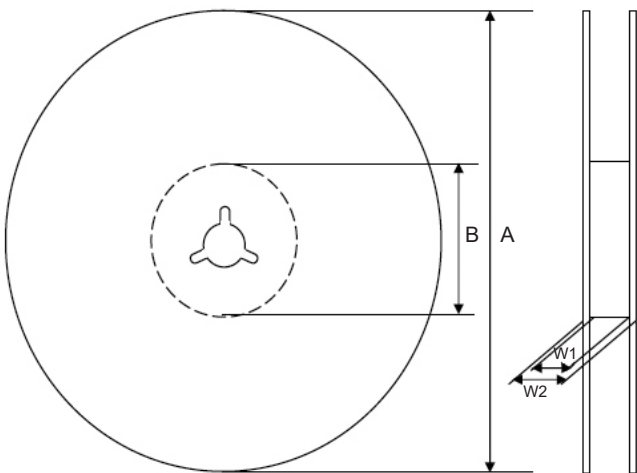

Case Size	Tape Width	W1	W2
4x5.5, 5x5.5	12.0	12.4 ~ 14.4	15.5 ~ 20.0
6.3x5.5	16.0	16.4 ~ 18.4	19.5 ~ 24.0

Case Size	Tape Width	A	B	C	D	E
4x5.5, 5x5.5	12.0	$\phi 330$	$\phi 50 \sim 105$	$\phi 13$	$\phi 21$	2.0
6.3x5.5	16.0	± 2.0		± 0.5	± 1.0	± 0.5

Color
Black or Blue

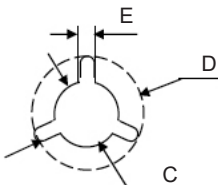

Case Size	Quantity Per Reel	
	13" Reel	15" Reel
4x5.5	1,500 pcs	2,000 pcs
5x5.5	1,000 pcs	1,000 pcs
6.3x5.5	1,000 pcs	1,000 pcs



X-ON Electronics

Largest Supplier of Electrical and Electronic Components

Click to view similar products for [nic manufacturer](#):

Other Similar products are found below :

[NMC0603NPO0R6B50TRPF](#) [NMC0603NPO270J100TRPF](#) [NMC1206X5R226K6.3TRPLP2KF](#) [NRE-S100M25V4X7F](#) [NRE-
HS102M25V12.5X16F](#) [NRCA12F1001TRQYF](#) [NRC-S06F2212TRF](#) [NCD180J1KVNPOJTRF](#) [NRC-S06F1692TRF](#)
[NCD102M1KVZ5U.250STRF](#) [NTC-T105K20TRAF](#) [NMC-P1206X7R104K100TRPF](#) [NMC-H1206NPO471K1KVTRPLPF](#) [NML04J9N1TRF](#)
[NRSNA4I4J150TR40KF](#) [NCC0805F261HTRF](#) [NRWA470M35V6.3X11TBF](#) [NACE221M16V6.3X8TR13F](#) [NRSS332M50V18X35.5F](#)
[NDTM106K25F1TRF](#) [NACZ221M50V10X10.5TR13F](#) [NCM15X7R103K50F](#) [NCD103M1KVZ5UF](#) [NRSS682M25V18X35.5F](#)
[NEXC224Z5.5V10.5X8.5TRF](#) [NRLRW221M450V30X35SF](#) [NDTM225K50F2TRF](#) [NRSZ471M50V12.5X20F](#) [NTCL106K35TRDF](#)
[NRWA331M25V10X12.5F](#) [NRSY472M25V16X31.5F](#) [NEXS105Z5.5V28.5X14F](#) [NRLR181M400V25X30SF](#) [NRSZ102M25V12.5X20F](#)
[NUVA33T385TRF](#) [NUVA33V405TRF](#) [NRLMW331M250V30X25F](#) [NRLF103M25V35X20F](#) [NDTM106K35F](#) [NRLMW102M200V35X35F](#)
[NPIS43LS220MTRF](#) [NDTM476K35F2F](#) [NTC-T475K50TRDF](#) [NCD222M1KVZ5UKF](#) [NRLR472M63V25X40SF](#) [NTP157M10TRD\(40\)F](#)
[NPIM74C3R3MTRF](#) [NPI104C100MTRF](#) [NRLM102M100V25X25F](#) [NRLM223M50V 35X50F](#)