

FEATURES

- RECTANGULAR PACKAGE WITH METAL STRIP FUSE ELEMENT
- EIA SIZES 0402, 0603, 0805 AND 1206
- CURRENT RATINGS FROM 0.2 ~ 5.0 AMPS
- SAFETY STANDARD APPROVAL (UL and c-UL File Number E302168)
- Pb-FREE COMPATIBLE WITH FLOW AND REFLOW SOLDERING



RoHS Compliant
includes all homogeneous materials

*See Part Number System for Details

SPECIFICATIONS

Type	Case Size	Rated Current (Amps)	Rated Voltage (Vdc)	Temperature Range	Case Dimensions				
					L	W	H	P ₁	P ₂
NFCC04	0402	0.2 ~ 1.25	24	-55°C ~ +125°C	1.0 ± 0.05	0.5 ± 0.05	0.4 ± 0.10	0.2 ± 0.10	0.25 ± 0.10
NFHC04		1.6 ~ 3.15							
NFCC06	0603	0.15 ~ 2.5	32		1.6 ± 0.10	0.8 +0.15/-0.05	0.45 ± 0.10	0.3 ± 0.15	0.3 ± 0.10
NFHC06		3.15 ~ 4.0							
NFCC08	0805	0.4 ~ 2.5	50		2.0 ± 0.10	1.25 ± 0.10	0.6 ± 0.10	0.4 ± 0.20	0.4 ± 0.20
NFHC08		3.15 ~ 5.0							
NFCC12	1206	0.2 ~ 2.5	50		3.2 ± 0.20	1.6 ± 0.15	0.6 ± 0.10	0.5 ± 0.25	0.5 ± 0.25
NFHC12		3.15 ~ 5.0			32	0.65 ± 0.10			

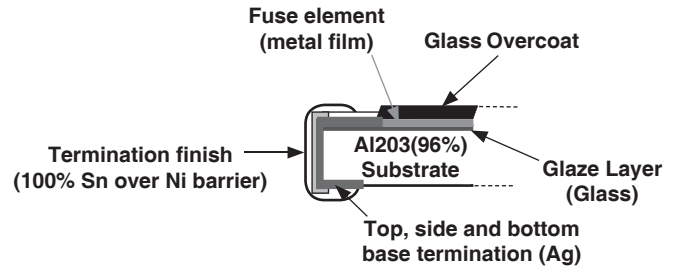
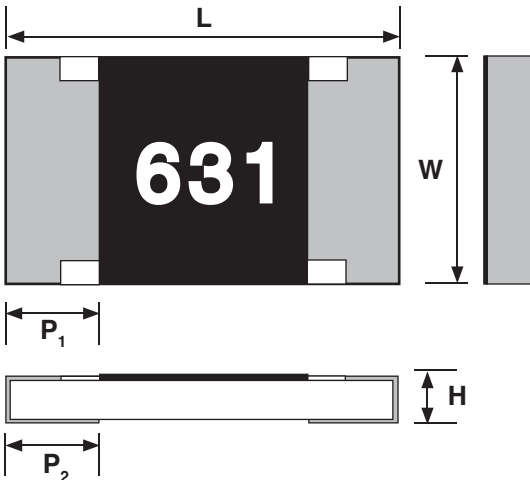

PART NUMBERING SYSTEM

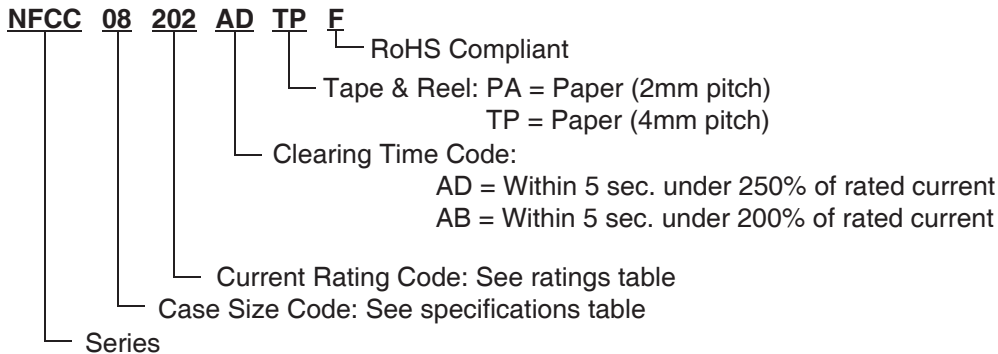

AVAILABLE VALUES AND RATINGS

Part Number	Case Size	Current Rating @ +70°C	Marking Symbol	Internal (Cold) Resistance (mΩ) max.	Melting I ² T (t=1ms) (A ² ·s) typical	Voltage Drop (R/C x 100) mV typical	Rated Voltage (DC)	Breaking Capacity (Amps)	Time/Current Characteristics						
									Current	Pre-arc time					
NFCC04 201ADPAF	0402	0.2	Z	1000	0.0005929	199	24	35	250%	5 sec. max.					
NFCC04 251ADPAF		0.25	C	750	0.0008464	172									
NFCC04 321ADPAF		0.315	D	620	0.00169	153									
NFCC04 401ADPAF		0.4	E	340	0.0023104	139									
NFCC04 501ADPAF		0.5	F	290	0.004305625	125									
NFCC04 631ADPAF		0.63	I	210	0.00625	121									
NFCC04 801ADPAF		0.8	K	150	0.0119025	121									
NFCC04 102ADPAF		1.0	L	120	0.0207025	114									
NFCC04 132ADPAF		1.25	M	90	0.03364	110									
NFHC04 162ADPAF		1.6	N	55	0.0442225	86									
NFHC04 202ADPAF		2.0	S	40	0.07744	86									
NFHC04 252ADPAF		2.5	T	36	0.15625	36									
NFHC04 322ADPAF		3.15	U	26	0.37636	26									
NFCC06 151ADTPF		0603	0.15	0D	4000	0.00036					521	32	35	250%	5 sec. max.
NFCC06 201ADTPF	0.2		ZD	1800	0.00081	347									
NFCC06 251ADTPF	0.250		CD	1000	0.0011025	209									
NFCC06 321ADTPF	0.315		DD	750	0.00169	208									
NFCC06 401ADTPF	0.4		ED	330	0.0023104	126									
NFCC06 501ADTPF	0.5		FD	280	0.0036864	124									
NFCC06 631ADTPF	0.63		ID	200	0.00676	126									
NFCC06 801ADTPF	0.8		KD	130	0.0105625	97									
NFCC06 102ADTPF	1.0		LD	110	0.016	107									
NFCC06 132ADTPF	1.25		MD	85	0.03249	98									
NFCC06 162ADTPF	1.6		ND	70	0.064	107									
NFCC06 202ADTPF	2.0		SD	55	0.13689	106									
NFCC06 252ADTPF	2.5		TD	45	0.23716	109									
NFHC06 322ADTPF	3.15		UD	26	0.4	88	24	35	250%	5 sec. max.					
NFHC06 402ADTPF	4.0		XD	19	0.784	90									
NFCC08 401ADTPF	0805		0.4	401	330	0.0024025	123	50	50	250%	5 sec. max.				
NFCC08 501ADTPF			0.5	501	270	0.0033489	120								
NFCC08 631ADTPF			0.63	631	190	0.0044944	114								
NFCC08 801ADTPF			0.8	801	130	0.0093025	96								
NFCC08 102ADTPF			1.0	102	100	0.01444	102								
NFCC08 132ADTPF			1.25	132	80	0.02704	99								
NFCC08 162ADTPF			1.6	162	65	0.0442225	102								
NFCC08 202ADTPF		2.0	202	55	0.09025	115									
NFCC08 252ADTPF		2.5	252	40	0.13456	110									
NFHC08 322ADTPF		3.15	UD	26	0.46225	85	32					50	250%	5 sec. max.	
NFHC08 402ADTPF		4.0	XD	19	0.841	82									
NFHC08 502ADTPF		5.0	YD	14	1.48225	70	24								
NFCC12 201ADTPF		1206	0.2	201	1800	0.000570025	341					50	50	250%	5 sec. max.
NFCC12 251ADTPF			0.25	251	1000	0.0009216	227								
NFCC12 321ADTPF	0.315		321	750	0.0015129	213									
NFCC12 401ADTPF	0.4		401	350	0.0024025	141									
NFCC12 501ADTPF	0.5		501	295	0.0033124	115									
NFCC12 631ADTPF	0.63		631	200	0.0058564	127									
NFCC12 801ADTPF	0.8		801	140	0.0087025	114									
NFCC12 102ADTPF	1.0		102	110	0.0156025	103									
NFCC12 132ADTPF	1.25		132	85	0.02916	104									
NFCC12 152ADTPF	1.5		152	78	0.04624	101									
NFCC12 162ADTPF	1.6		162	75	0.0664225	110									
NFCC12 202ADTPF	2.0		202	65	0.1	109									
NFCC12 252ADTPF	2.5		252	45	0.18769	111									
NFHC12 322ADTPF	3.15		UD	26	0.4	90	32	50	250%	5 sec. max.					
NFHC12 402ADTPF	4.0		XD	19	0.784	84									
NFHC12 502ADTPF	5.0		YD	14	1.40625	83									



AVAILABLE VALUES AND RATINGS

Part Number	Case Size	Current Rating @ +70°C	Marking Symbol	Internal (Cold) Resistance (mΩ) max.	Melting I ² T (t=1ms) (A ² xs) typical	Voltage Drop (R/C x 100) mV typical	Rated Voltage (DC)	Breaking Capacity (Amps)	Time/Current Characteristics	
									Current	Pre-arc time
NFCC04 251ABPAF	0402	0.25	C	1000	0.0005929	265	24	35	200%	5 sec. max.
NFCC04 321ABPAF		0.315	D	750	0.00081	229				
NFCC04 401ABPAF		0.4	E	620	0.0016384	210				
NFCC04 501ABPAF		0.5	F	340	0.00225	188				
NFCC04 631ABPAF		0.63	I	290	0.00441	170				
NFCC04 751ABPAF		0.75	A	220	0.0055225	179				
NFCC04 801ABPAF		0.8	K	210	0.00625	168				
NFCC04 102ABPAF		1.0	L	150	0.0126025	164				
NFCC04 132ABPAF		1.25	M	120	0.0207025	156				
NFCC04 152ABPAF		1.5	H	100	0.02809	166				
NFCC04 162ABPAF		1.6	N	90	0.036	156				
NFHC04 202ABPAF		2.0	S	55	0.04624	121				
NFHC04 252ABPAF		2.5	T	40	0.07744	119				
NFCC06 251ABTPF		0603	0.25	CB	1800	0.0006084				
NFCC06 321ABTPF	0.315		DB	1000	0.0010404	281				
NFCC06 401ABTPF	0.4		EB	750	0.0017424	289				
NFCC06 501ABTPF	0.5		FB	330	0.0024964	167				
NFCC06 631ABTPF	0.63		IB	280	0.0036864	166				
NFCC06 751ABTPF	0.75		AB	210	0.0054289	165				
NFCC06 801ABTPF	0.8		KB	200	0.00625	175				
NFCC06 102ABTPF	1.0		LB	130	0.0099225	133				
NFCC06 132ABTPF	1.25		MB	110	0.0164025	144				
NFCC06 152ABTPF	1.5		HB	95	0.02704	135				
NFCC06 162ABTPF	1.6		NB	85	0.0330625	136				
NFCC06 202ABTPF	2.0		SB	70	0.05929	146				
NFCH06 252ABTPF	2.5		TB	40	0.14884	115				
NFCC08 501ABTPF	0805		0.5	FB	330	0.0024025	162	50	50	200%
NFCC08 631ABTPF		0.63	IB	270	0.0033124	164				
NFCC08 801ABTPF		0.8	KB	190	0.0047089	160				
NFCC08 102ABTPF		1.0	LB	130	0.0081225	129				
NFCC08 132ABTPF		1.25	MB	100	0.0133225	138				
NFCC08 162ABTPF		1.6	NB	80	0.02704	139				
NFCC08 202ABTPF		2.0	SB	65	0.05041	139				
NFHC08 252ABTPF	2.5	TB	40	0.11664	118	32	50	200%	5 sec. max.	

Current vs. Temperature Derating Guide

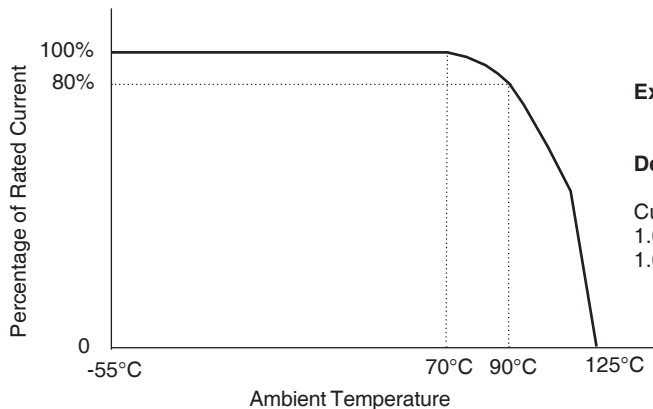

Nominal Derating

Option Code AD: ≤ 80% of Rated Current
 Option Code AB: ≤ 70% of Rated Current

Example: P/N NFCC0603102AB
 Rated Current: 1.0A @ 70°C

Derating at 90°C:

Current Rating x Normal Derating x Temperature Derating at +90°C
 1.0A (Rated Current) x 0.70 (Type AB) x 0.80 (Temperature Derating) = 0.56A
 1.0A (Rated Current) x 0.80 (Type AD) x 0.80 (Temperature Derating) = 0.64A



Item		Specification	Test Method
Surface Temperature Rise		75°C	Ambient Temperature: 10°C ~ 30°C
Current Capability		No fusing	Applied Current: Rated Current
Working Temperature Range		-55°C ~ +125°C	Rated Current x 110% @ 70°C ± 2°C for 1 hr
Time/Current Characteristic		See Available Values and Ratings Tables	
Option Code	AD	Rated Current x 250% Pre-acting time 5 sec. max.	Test current shall be applied continuously to the fuse mounted on the test substrate
	AB	Rated Current x 200% Pre-acting time 5 sec. max.	
Bending Strength		No Visible Damage Internal Resistance Change ±3% (AD, AB)	JIS C0051:1994 7.4.1 On the test substrate bending value is 3mm for 10 ±1 sec.
Solderability		At least 95% coverage of the terminal surface	JIS C0054:1994 Immersion into solder at 235C ±5°C for 2 ± 0.5 secs. Immersion into solder at 260°C for 10 sec.
Resistance to Soldering Heat		No Visible Damage Internal resistance range ±10% max.	Reflow Soldering 1. Pre-heating: 150°C ±5°C, 120 sec. max. 2. T max. 240°C ±5°C, 10 sec. max, 2 passes
Endurance (Load Life)		Within 10% of voltage drop	At normal ambient temperature & RH on the test substrate Rated Current x 1.05, 1 hour "ON", 1/4 hour "OFF", 100 cycles Rated current x 1.25 for 1 hour

RECOMMENDED REFLOW PROFILE

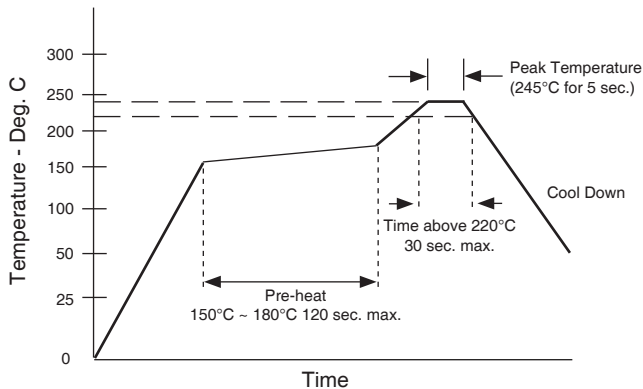

RECOMMENDED FLOW PROFILE

Note: 0402 Reflow Only

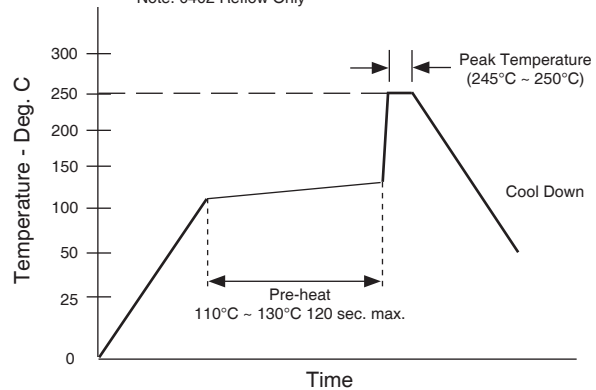

Recommended Land Pattern Dimensions (mm)

Case Size	Reflow Soldering				Flow Soldering			
	A	B	C	D	A	B	C	D
0402	0.5	1.3	0.5	0.4	N/A			
0603	1.0	2.0	0.8	0.5	1.0	2.6	0.8	0.8
0805	1.3	2.7	1.25	0.7	1.3	3.1	1.25	0.9
1206	2.2	3.9	1.6	0.85	2.2	4.3	1.6	1.05

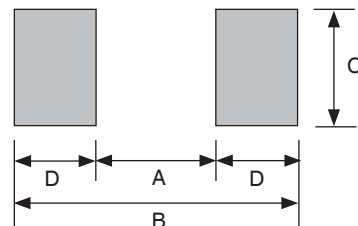

FUSING TIME CURRENT CHARACTERISTICS
(see website: www.niccomp.com/catalog/fusingcharacteristics.pdf)



CARRIER TAPE DIMENSIONS (mm)

Type	A	B	W	F	E	P ₁	P ₀	φD	T ₁	T ₂	Qty/Reel
NFCC04/NFHC04	0.65 ±0.10	1.15 ±0.10	8.00 ±0.20	3.50 ±0.05	1.75 ±0.10	2.00 ±0.05	4.00 ±0.05	1.55 ±0.05	0.60 ±0.05	0.70 max.	10,000

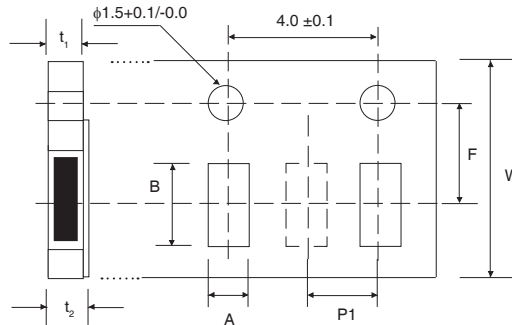

CARRIER TAPE DIMENSIONS (mm)

Type	A	B	W	F	E	P ₁	P ₀	φD	T ₁	T ₂	Qty/Reel
NFCC06/NFHC06	1.15 ±0.15	1.90 ±0.20	8.00 ±0.20	3.50 ±0.05	1.75 ±0.10	4.00 ±0.05	4.00 ±0.05	1.55 ±0.05	0.7 max.	0.8 max.	5,000
NFCC08/NFHC08	1.65 ±0.15	2.50 ±0.20									
NFCC12/NFHC12	2.00 ±0.15	3.6 ± 0.20							0.9 max.	1.0 max.	

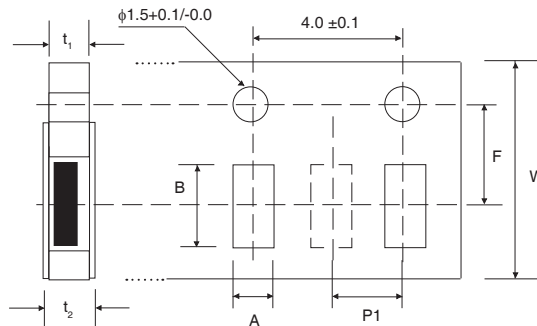

REEL DIMENSIONS (mm) AND QUANTITY

Type	A +0/-3	B +1/-0	C ±0.20	W ±0.3	Qty
NFCC04/NFHC04	180	60	13	9.0	10,000
NFCC06/NFHC06					5,000
NFCC08/NFHC08					
NFCC12/NFHC12					

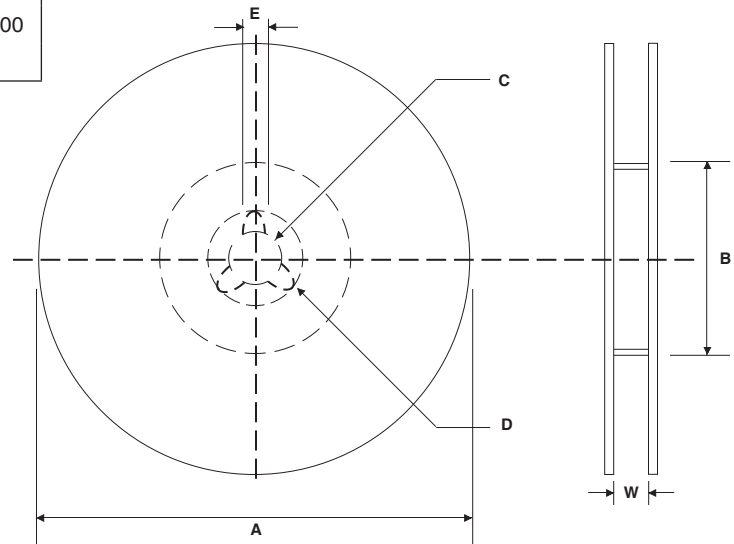

X-ON Electronics

Largest Supplier of Electrical and Electronic Components

Click to view similar products for [Resettable Fuses - PPTC category](#):

Click to view products by [NIC manufacturer](#):

Other Similar products are found below :

[0001.1010.G](#) [D38999/20WG39JN](#) [F02B250V1-4AS](#) [9728214S-2\(621\)](#) [RF0627-000](#) [RF2534-000](#) [ASMD185-2](#) [EN2997S61212AN](#)
[EN2997SE61203AN](#) [BK-ABC-V-5-R](#) [LR4-550RAF](#) [SMD125-2](#) [F60C500V20AS](#) [RF0078-000](#) [RF1548-000](#) [RF1973-000](#) [RF2171-000](#)
[RF2531-000](#) [RF2533-000](#) [RF2550-000](#) [TR600-150Q-B-0.5-0.130](#) [BK-AGX-20](#) [5E4795/04-1502](#) [EN2997S61212MN](#) [EN2997SE61203MN](#)
[EN2997SE61212AN](#) [EN2997SE61212MN](#) [BK1/S505-1.25-R](#) [TR-3216FF20-R](#) [TRF250-080T-B-1.0-0.125](#) [JT06RT1832BN014](#) [S-3-2-10](#)
[SMD100-2](#) [FRN-R-5-6-10](#) [FRS-R-3-2-10](#) [LP-CC-2-1-2](#) [LPS-RK-3-2-10SP](#) [BK-AGC-1-8-R](#) [BK-AGC-2-10-R](#) [BK-AGC-7-1-2](#) [BK-GDC-](#)
[500MA](#) [BK-MDL-1-6-10-R](#) [BK-SFE-4](#) [BK-ABC-1-R](#) [BK-C518-250-R](#) [BK-GDB-2A](#) [BK-MDL-1-8-R](#) [BK-MDL-6](#) [BK-AGC-5-R](#) [BK-ATC-](#)