

FEATURES

- SIZES K(0402), J (0603), D (0805), C (1008), E (1206), A (1210) and B (1812)
- HIGH Q, HIGH CURRENT AND HIGH SRF CHARACTERISTICS
- REFLOW SOLDERING APPLICABLE
- HIGH INDUCTANCE AVAILABLE IN SMALL SIZE
- EMBOSSED PLASTIC CARRIER PACKAGING FOR AUTOMATIC PICK-PLACE*

*0402 PUNCHED CARDBOARD CARRIER

Specifications	Case Size Code			
	0402 (K)	0603 (J)	0805 (D)	1008 (C)
Inductance Range	1.0nH ~ 68nH	1.8nH ~ 270nH	2.2nH ~ 910nH	10nH ~ 4.7μH
Inductance Tolerance	±0.3nH (S), ±5% (J), ±2% (G), ±5% (J), ±10% (K), ±20% (M)			
Operating Temperature Range	-40°C ~ +125°C			

Specifications	1206 (E)	1210 (A)	1812 (B)
	Inductance Range	3.3nH ~ 1.2μH	3.9nH ~ 8.6μH
Inductance Tolerance	See Product Standard Values Tables		
Operating Temperature Range	-40°C ~ +125°C		

ENVIRONMENTAL CHARACTERISTICS

Test	Specifications	Test Method & Condition
Solderability	75% Min. Coverage	After 3 sec. dip in +230°C soldering pot (post flux)
Resistance to Soldering Heat	(1) No evidence of damage (2) Inductance change ±5% of initial value (3) Q factor within ±10% of initial value (±20% for 0402 & 0603 case sizes)	After 5 seconds at +260°C (with pre-conditioning)
Humidity	(1) No evidence of damage	After 500 hours at 60°C and 90 ~ 95% RH (0402 case size - after 96 hours 50°C and 90 ~ 95% RH)
Low Frequency Vibration	(2) Inductance change ±5% of initial value (±10% for 0402 case size)	After 2 hrs per axis, 10 ~ 55Hz, 1.5mm amplitude
Thermal Shock	(3) Q factor within ±10% of initial value (±20% for 0402 & 0603 case sizes)	After 100 cycles (10 cycles 0402) at -40°C and +125°C (30 minutes at each temperature)
Low Temperature Storage		After 500 hrs at -40°C
High Temperature Load Life	(1) No evidence of damage (2) Inductance change ±10% of initial value (±20% for 0402 case size) (3) Q factor within ±10% of initial value (±20% for 0402 & 0603 case sizes)	After 500 hrs at +125°C with rated DC current (0402 case size - after 1,000 hrs at +85°C)
Humidity Load Life	No evidence of short or open circuit	After 500 hrs at 60°C with 90 ~ 95% RH with rated DC current (0402 case size- 1,000 hrs at +40°C)

COMPONENT DIMENSIONS (mm):

Type	Case Size	A max.	B max.	C max.	D typ.	E typ.	F typ.
NIN-HK	0402	1.19	0.64	0.66	0.20	0.523	0.215
NIN-HJ	0603	1.80	1.12	1.02	0.38	0.76	0.33
NIN-HD	0805	2.29	1.68	1.55	0.51	1.27	0.50
NIN-HC	1008	2.92	2.79	2.29	0.51	2.10	0.50
NIN-HE	1206	3.56	2.16	1.52	.051	1.60	0.50
NIN-HA	1210	3.65	2.95	2.70	0.51	2.10	.050
NIN-HB	1812	4.95	3.81	3.43	1.78	2.90	.058

RECOMMEND LAND PATTERN DIMENSIONS (mm)

Type	H typ.	I typ.	J typ.
NIN-HK	0.65	0.35	0.50
NIN-HJ	1.02	0.36	0.46
NIN-HD	1.78	1.02	0.76
NIN-HC	2.54	1.02	1.27
NIN-HE	1.93	1.02	1.78
NIN-HA	3.02	1.02	1.78
NIN-HB	3.05	1.14	3.00

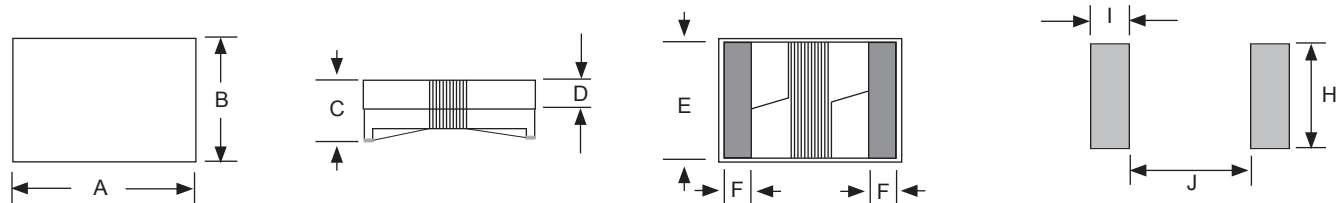

NIN-HK SERIES

K-SIZE (0402)

STANDARD VALUES

NIC P/N	INDUCTANCE TOLERANCE	INDUCTANCE VALUE (nH)	FREQUENCY (MHz)	Q FACTOR	SRF (MHz) Minimum	Rated DC Resistance (ohms)	Rated DC Current (mA)
NIN-HK1N0STRF	S	1.0	250	16@250MHz	7000	0.054	1360
NIN-HK2N0STRF	S	2.0	250	19@250MHz	7000	0.084	1040
NIN-HK2N2STRF	S	2.2	250	19@250MHz	7000	0.084	960
NIN-HK2N7STRF	S	2.7	250	19@250MHz	7000	0.095	840
NIN-HK3N3STRF	S	3.3	250	19@250MHz	7000	0.079	840
NIN-HK3N9STRF	S	3.9	250	19@250MHz	6000	0.079	840
NIN-HK5N2JTRF	J	5.2	250	20@250MHz	4800	0.120	640
NIN-HK5N6JTRF	J	5.6	250	20@250MHz	4700	0.099	760
NIN-HK6N8JTRF	J	6.8	250	20@250MHz	4800	0.099	680
NIN-HK8N2JTRF	J	8.2	250	21@250MHz	4400	0.136	680
NIN-HK8N5JTRF	J	8.5	250	24@250MHz	4400	0.150	680
NIN-HK9N0JTRF	J	9.0	250	24@250MHz	3900	0.170	680
NIN-HK100JTRF	J	10	250	21@250MHz	3900	0.240	480
NIN-HK120JTRF	J	12	250	24@250MHz	3600	0.168	640
NIN-HK150JTRF	J	15	250	24@250MHz	3300	0.204	560
NIN-HK180JTRF	J	18	250	24@250MHz	3100	0.276	420
NIN-HK220JTRF	J	22	250	24@250MHz	2800	0.360	400
NIN-HK270JTRF	J	27	250	24@250MHz	2500	0.360	400
NIN-HK330JTRF	J	33	250	24@250MHz	2400	0.450	400
NIN-HK360JTRF	J	36	250	24@250MHz	2320	0.440	320
NIN-HK390JTRF	J	39	250	25@250MHz	2100	0.660	200
NIN-HK430JTRF	J	43	200	25@250MHz	2000	0.744	175
NIN-HK470JTRF	J	47	200	20@250MHz	2100	0.792	175
NIN-HK560JTRF	J	56	200	22@250MHz	1800	0.780	175
NIN-HK680JTRF	J	68	200	22@250MHz	1600	0.912	150

Note: Extended values, tolerances, and enhanced versions are available please contact NIC for more details.

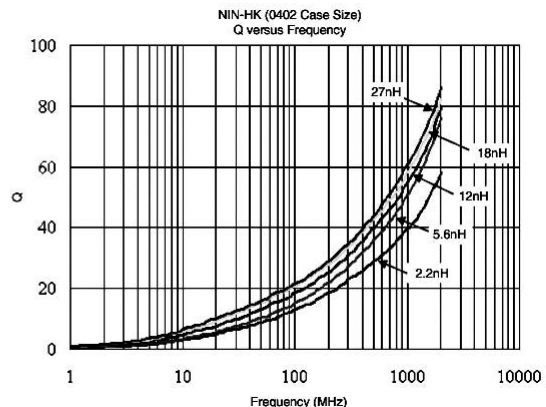
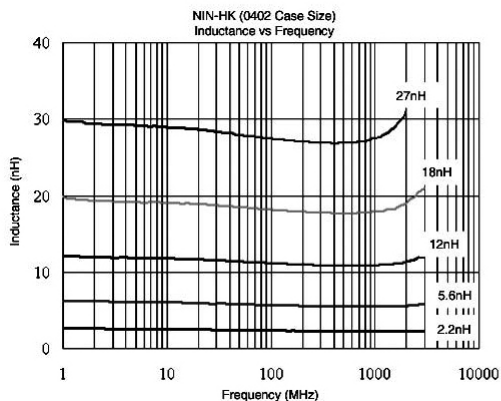

NIN-HJ SERIES

J-SIZE (0603)

STANDARD VALUES

NIC P/N	INDUCTANCE TOLERANCE	INDUCTANCE VALUE (nH)	FREQUENCY (MHz)	Q FACTOR	SRF (MHz) Minimum	Rated DC Resistance (ohms)	Rated DC Current (mA)
NIN-HJ1N8_TRF	J,K,M	1.8	250	16@250MHz	6000	0.10	700
NIN-HJ3N9_TRF	J,K,M	3.9	250	20@250MHz	6000	0.10	700
NIN-HJ4N7_TRF	J,K,M	4.7	250	10@250MHz	5800	0.25	700
NIN-HJ6N8_TRF	J,K,M	6.8	250	25@250MHz	5800	0.11	700
NIN-HJ8N2_TRF	J,K,M	8.2	250	30@250MHz	4200	0.13	700
NIN-HJ100_TRF	J,K,M	10	250	30@250MHz	4800	0.13	700
NIN-HJ120_TRF	G,J,K,M	12	250	30@250MHz	4000	0.13	700
NIN-HJ150_TRF	G,J,K,M	15	250	30@250MHz	4000	0.19	700
NIN-HJ180_TRF	G,J,K,M	18	250	30@250MHz	3100	0.20	700
NIN-HJ220_TRF	G,J,K,M	22	250	35@250MHz	3000	0.23	700
NIN-HJ270_TRF	G,J,K,M	27	250	35@250MHz	2800	0.20	600
NIN-HJ330_TRF	G,J,K,M	33	250	35@250MHz	2300	0.22	600
NIN-HJ390_TRF	G,J,K,M	39	250	35@250MHz	2200	0.25	600
NIN-HJ470_TRF	G,J,K,M	47	200	35@250MHz	2000	0.35	600
NIN-HJ560_TRF	G,J,K,M	56	200	35@250MHz	1900	0.38	600
NIN-HJ680_TRF	G,J,K,M	68	200	35@250MHz	1700	0.46	600
NIN-HJ720_TRF	G,J,K,M	72	150	34@250MHz	1700	0.46	400
NIN-HJ820_TRF	G,J,K,M	82	150	34@250MHz	1700	0.46	400
NIN-HJR10_TRF	G,J,K,M	100	150	34@250MHz	1400	0.52	400
NIN-HJR11_TRF	G,J,K,M	110	150	32@250MHz	1350	0.79	300
NIN-HJR12_TRF	G,J,K,M	120	150	32@250MHz	1300	0.82	300
NIN-HJR15_TRF	G,J,K,M	150	150	28@150MHz	990	1.00	280
NIN-HJR18_TRF	G,J,K,M	180	100	25@100MHz	990	1.20	240
NIN-HJR22_TRF	G,J,K,M	220	100	25@100MHz	990	2.00	200
NIN-HJR27_TRF	G,J,K,M	270	100	24@100MHz	990	2.30	170

Note: Extended values, tolerances, and enhanced versions are available please contact NIC for more details.

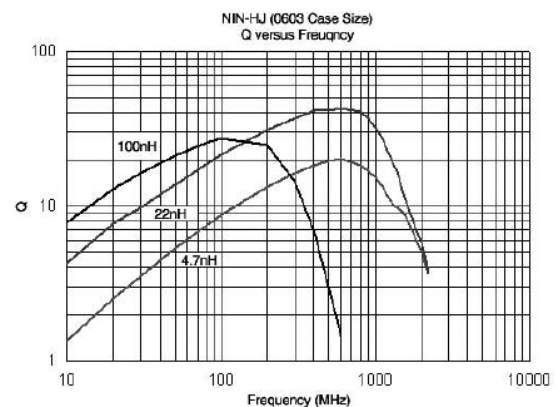
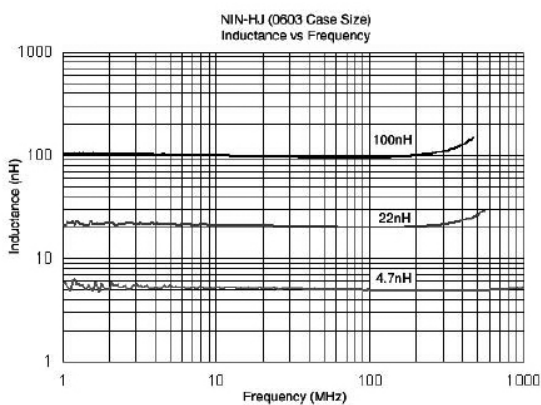

NIN-HD SERIES D-SIZE (0805) STANDARD VALUES

NIC P/N	INDUCTANCE TOLERANCE	INDUCTANCE VALUE (nH)	FREQUENCY L/Q(MHz)	Q FACTOR	SRF (MHz) Minimum	Rated DC Resistance (ohms)	Rated DC Current (mA)
NIN-HD2N2_TRF	J,K,M	2.2	250	40@1500MHz	6000	0.1	600
NIN-HD3N3_TRF	J,K,M	3.3	250	25@1500MHz	6000	0.15	600
NIN-HD4N7_TRF	J,K,M	4.7	250	50@1000MHz	5000	0.09	600
NIN-HD6N8_TRF	J,K,M	6.8	250	50@1000MHz	5000	0.11	600
NIN-HD8N2_TRF	J,K,M	8.2	250	50@1000MHz	4700	0.19	600
NIN-HD100_TRF	J,K,M	10	250	50@500MHz	4200	0.14	600
NIN-HD120_TRF	G,J,K,M	12	250	50@500MHz	4000	0.15	600
NIN-HD150_TRF	G,J,K,M	15	250	50@500MHz	2900	0.17	600
NIN-HD180_TRF	G,J,K,M	18	250	50@500MHz	3300	0.2	600
NIN-HD220_TRF	G,J,K,M	22	250	55@500MHz	2600	0.22	500
NIN-HD270_TRF	G,J,K,M	27	250	55@500MHz	2500	0.25	500
NIN-HD330_TRF	G,J,K,M	33	250	60@500MHz	2050	0.27	500
NIN-HD390_TRF	G,J,K,M	39	250	60@500MHz	2000	0.29	500
NIN-HD470_TRF	G,J,K,M	47	200	60@500MHz	1650	0.31	500
NIN-HD560_TRF	G,J,K,M	56	200	60@500MHz	1550	0.34	500
NIN-HD680_TRF	G,J,K,M	68	200	60@500MHz	1450	0.38	500
NIN-HD820_TRF	G,J,K,M	82	150	60@500MHz	1300	0.42	400
NIN-HDR10_TRF	G,J,K,M	100	150	60@500MHz	1200	0.46	400
NIN-HDR12_TRF	G,J,K,M	120	150	50@250MHz	1100	0.51	400
NIN-HDR15_TRF	G,J,K,M	150	100	50@250MHz	920	0.56	400
NIN-HDR18_TRF	G,J,K,M	180	100	50@250MHz	870	0.64	400
NIN-HDR22_TRF	G,J,K,M	220	100	45@250MHz	850	0.7	400
NIN-HDR27_TRF	G,J,K,M	270	100	40@250MHz	650	1	350
NIN-HDR33_TRF	G,J,K,M	330	100	40@250MHz	600	1.5	310
NIN-HDR39_TRF	G,J,K,M	390	100	35@250MHz	560	1.7	290
NIN-HDR47_TRF	G,J,K,M	470	50	33@100MHz	375	1.76	250
NIN-HDR56_TRF	G,J,K,M	560	25	23@50MHz	340	1.9	230
NIN-HDR68_TRF	G,J,K,M	680	25	23@50MHz	188	2.2	190
NIN-HDR82_TRF	G,J,K,M	820	25	23@50MHz	215	2.35	180
NIN-HDR91_TRF	G,J,K,M	910	25	22@50MHz	180	3	160

Note: Extended values, tolerances, and enhanced versions are available please contact NIC for more details.

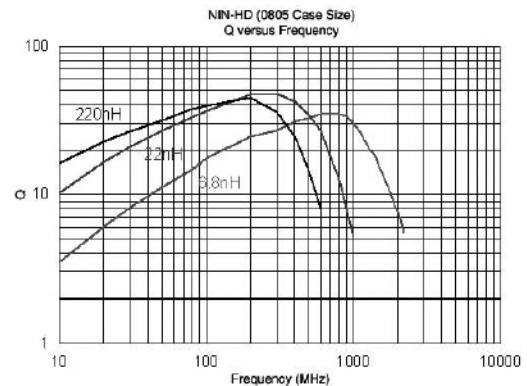
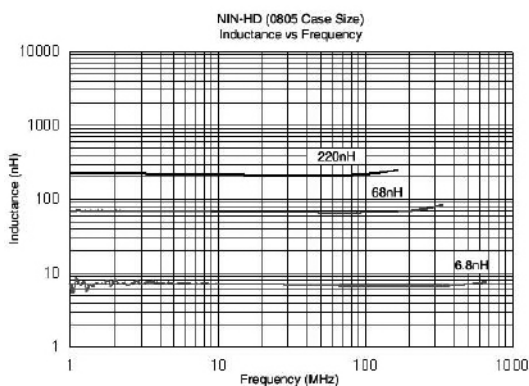

NIN-HC SERIES

C-SIZE (1008)

STANDARD VALUES

NIC P/N	INDUCTANCE TOLERANCE	INDUCTANCE VALUE (nH)	FREQUENCY L/Q(MHz)	Q FACTOR	SRF (MHz) Minimum	Rated DC Resistance (ohms)	Rated DC Current (mA)
NIN-HC100_TRF	J,K,M	10	50	50@500MHz	4100	0.08	1000
NIN-HC120_TRF	J,K,M	12	50	50@500MHz	3300	0.09	1000
NIN-HC150_TRF	J,K,M	15	50	40@500MHz	2500	0.1	500
NIN-HC180_TRF	J,K,M	18	50	50@350MHz	2500	0.11	1000
NIN-HC220_TRF	J,K,M	22	50	55@350MHz	2400	0.12	1000
NIN-HC270_TRF	J,K,M	27	50	55@350MHz	1600	0.13	1000
NIN-HC330_TRF	G,J,K,M	33	50	60@350MHz	1600	0.14	1000
NIN-HC390_TRF	G,J,K,M	39	50	60@350MHz	1500	0.15	1000
NIN-HC470_TRF	G,J,K,M	47	50	65@350MHz	1500	0.16	1000
NIN-HC560_TRF	G,J,K	56	50	65@350MHz	1300	0.18	1000
NIN-HC680_TRF	G,J,K	68	50	65@350MHz	1300	0.2	1000
NIN-HC820_TRF	G,J,K	82	50	60@350MHz	1000	0.22	1000
NIN-HCR10_TRF	G,J,K	100	25	60@350MHz	1000	0.56	650
NIN-HCR12_TRF	G,J,K	120	25	60@350MHz	950	0.63	650
NIN-HCR15_TRF	G,J,K	150	25	45@100MHz	850	0.7	580
NIN-HCR18_TRF	G,J,K	180	25	45@100MHz	750	0.77	620
NIN-HCR22_TRF	G,J,K	220	25	45@100MHz	700	0.84	500
NIN-HCR27_TRF	G,J,K	270	25	45@100MHz	600	0.91	500
NIN-HCR33_TRF	G,J,K	330	25	45@100MHz	570	1.05	450
NIN-HCR39_TRF	G,J,K	390	25	45@100MHz	500	1.12	470
NIN-HCR47_TRF	G,J,K	470	25	45@100MHz	450	1.19	470
NIN-HCR56_TRF	G,J,K	560	25	45@100MHz	415	1.33	400
NIN-HCR62_TRF	G,J,K	620	25	45@100MHz	375	1.4	400
NIN-HCR68_TRF	G,J,K	680	25	45@100MHz	375	1.47	400
NIN-HCR75_TRF	G,J,K	750	25	45@100MHz	360	1.54	360
NIN-HCR82_TRF	G,J,K	820	25	45@100MHz	350	1.61	360
NIN-HCR91_TRF	G,J,K	910	25	35@50MHz	320	1.68	330
NIN-HC1R0_TRF	G,J,K	1000	25	35@50MHz	290	1.75	330
NIN-HC1R2_TRF	G,J,K	1200	7.9	35@50MHz	250	2	280
NIN-HC1R5_TRF	G,J,K	1500	7.9	28@50MHz	200	2.3	280
NIN-HC1R8_TRF	G,J,K	1800	7.9	28@50MHz	160	2.6	270
NIN-HC2R2_TRF	G,J,K	2200	7.9	22@50MHz	160	2.8	250
NIN-HC2R7_TRF	G,J,K	2700	7.9	22@25MHz	140	4.78	250
NIN-HC3R3_TRF	G,J,K	3300	7.9	22@25MHz	110	5.26	250
NIN-HC3R9_TRF	G,J,K	3900	7.9	20@25MHz	100	5.75	230
NIN-HC4R7_TRF	G,J,K	4700	7.9	18@25MHz	90	6.3	230

Note: Extended values, tolerances, and enhanced versions are available please contact NIC for more details.

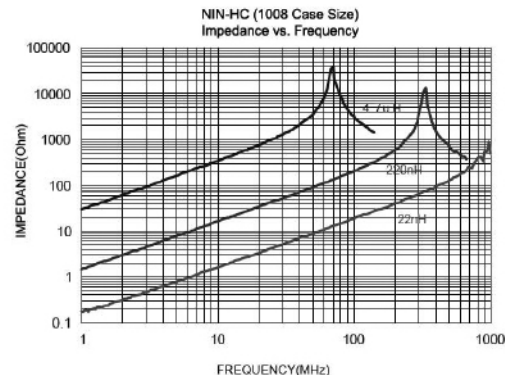
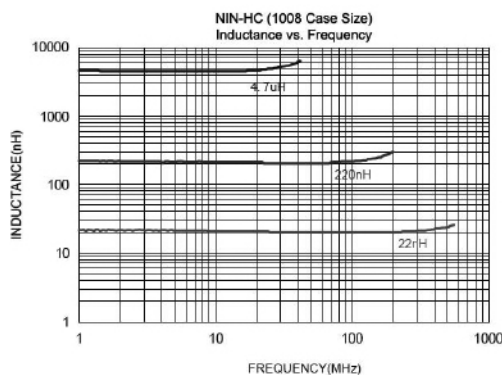

NIN-HE SERIES

E-SIZE (1206)

STANDARD VALUES

NIC P/N	INDUCTANCE VALUE (nH)	INDUCTANCE TOLERANCE	FREQUENCY L/Q(MHz)	Q FACTOR	SRF (MHz) Minimum	Rated DC Resistance (ohms)	Rated DC Current (mA)
NIN-HE3N3_TRF	3.3	G, J, K	100/300	20@300MHz	6200	0.07	1000
NIN-HE6N8_TRF	6.8	G, J, K	100/300	30@300MHz	5500	0.07	1000
NIN-HE100_TRF	10	G, J, K	100/300	40@300MHz	4000	0.09	1000
NIN-HE120_TRF	12	G, J, K	100/300	40@300MHz	3200	0.09	1000
NIN-HE150_TRF	15	G, J, K	100/300	40@300MHz	3200	0.12	1000
NIN-HE180_TRF	18	G, J, K	100/300	45@300MHz	2800	0.12	1000
NIN-HE220_TRF	22	G, J, K	100/300	50@300MHz	2200	0.12	1000
NIN-HE270_TRF	27	G, J, K	100/300	50@300MHz	1800	0.12	1000
NIN-HE330_TRF	33	G, J, K	100/300	50@300MHz	1800	0.12	1000
NIN-HE390_TRF	39	G, J, K	100/300	50@300MHz	1800	0.12	1000
NIN-HE470_TRF	47	G, J, K	100/300	50@300MHz	1500	0.13	1000
NIN-HE560_TRF	56	G, J, K	100/300	55@300MHz	1450	0.14	1000
NIN-HE680_TRF	68	G, J, K	100/300	55@300MHz	1200	0.26	900
NIN-HE820_TRF	82	G, J, K	100/300	55@300MHz	1200	0.21	900
NIN-HER10_TRF	100	G, J, K	100/300	55@300MHz	1100	0.3	850
NIN-HER12_TRF	120	G, J, K	100/300	60@300MHz	1100	0.3	800
NIN-HER15_TRF	150	G, J, K	100/300	55@300MHz	950	0.31	750
NIN-HER18_TRF	180	G, J, K	50/300	60@300MHz	900	0.43	700
NIN-HER22_TRF	220	G, J, K	50/300	60@300MHz	760	0.56	670
NIN-HER27_TRF	270	G, J, K	50/300	50@300MHz	730	0.56	630
NIN-HER33_TRF	330	G, J, K	50/150	45@150MHz	650	0.7	590
NIN-HER39_TRF	390	G, J, K	50/150	45@150MHz	600	0.8	530
NIN-HER47_TRF	470	G, J, K	50/150	45@150MHz	550	1.3	490
NIN-HER56_TRF	560	G, J, K	35/150	45@150MHz	470	1.34	460
NIN-HER68_TRF	680	G, J, K	35/150	45@150MHz	450	1.58	430
NIN-HER82_TRF	820	G, J, K	35/150	45@150MHz	420	1.82	400
NIN-HE1R0_TRF	1000	G, J, K	35/150	45@150MHz	400	2.8	320
NIN-HE1R2_TRF	1200	G, J, K	35/150	45@150MHz	380	3.2	300

Note: Extended values, tolerances, and enhanced versions are available please contact NIC for more details.

NIN-HA SERIES

A-SIZE (1210)

STANDARD VALUES

NIC P/N	INDUCTANCE VALUE (nH)	INDUCTANCE TOLERANCE	FREQUENCY L/Q(MHz)	Q FACTOR	SRF (MHz) Minimum	Rated DC Resistance (ohms)	Rated DC Current (mA)
NIN-HA3N9_TRF	3.9	G, J, K	100/300	30@300MHz	6000	0.05	1000
NIN-HA4N7_TRF	4.7	G, J, K	100/300	30@300MHz	5800	0.065	1000
NIN-HA8N2_TRF	8.2	G, J, K	100/300	30@300MHz	5500	0.07	1000
NIN-HA100_TRF	10	G, J, K	100/300	40@300MHz	4000	0.08	1000
NIN-HA120_TRF	12	G, J, K	100/300	40@300MHz	3200	0.08	1000
NIN-HA150_TRF	15	G, J, K	100/300	40@300MHz	3200	0.1	1000
NIN-HA180_TRF	18	G, J, K	100/300	50@300MHz	2800	0.1	1000
NIN-HA220_TRF	22	G, J, K	100/300	50@300MHz	2200	0.1	1000
NIN-HA270_TRF	27	G, J, K	100/300	50@300MHz	1800	0.11	1000
NIN-HA330_TRF	33	G, J, K	100/300	55@300MHz	1800	0.11	1000
NIN-HA390_TRF	39	G, J, K	100/300	55@300MHz	1500	0.12	1000
NIN-HA430_TRF	43	G, J, K	100/300	55@300MHz	1500	0.12	1000
NIN-HA470_TRF	47	G, J, K	100/300	55@300MHz	1500	0.13	1000
NIN-HA560_TRF	56	G, J, K	100/300	55@300MHz	1450	0.14	1000
NIN-HA680_TRF	68	G, J, K	100/300	55@300MHz	1200	0.15	900
NIN-HA820_TRF	82	G, J, K	100/300	55@300MHz	1000	0.2	900
NIN-HAR10_TRF	100	G, J, K	100/300	55@300MHz	900	0.2	850
NIN-HAR12_TRF	120	G, J, K	100/300	60@300MHz	800	0.25	800
NIN-HAR15_TRF	150	G, J, K	100/300	60@300MHz	700	0.25	750
NIN-HAR18_TRF	180	G, J, K	50/300	60@300MHz	650	0.3	700
NIN-HAR22_TRF	220	G, J, K	50/300	60@300MHz	650	0.4	770
NIN-HAR27_TRF	270	G, J, K	50/300	40@300MHz	580	0.4	630
NIN-HAR33_TRF	330	G, J, K	50/150	45@150MHz	580	0.58	590
NIN-HAR39_TRF	390	G, J, K	50/150	45@150MHz	510	0.58	530
NIN-HAR47_TRF	470	G, J, K	50/150	45@150MHz	480	0.8	490
NIN-HAR56_TRF	560	G, J, K	35/150	45@150MHz	420	1.1	460
NIN-HAR68_TRF	680	G, J, K	35/150	45@150MHz	400	1.2	430
NIN-HAR82_TRF	820	G, J, K	35/150	45@150MHz	370	1.82	400
NIN-HA1R0_TRF	1000	G, J, K	35/150	45@150MHz	340	1.85	320
NIN-HA1R2_TRF	1200	G, J, K	35/150	35@150MHz	220	1.87	300
NIN-HA1R5_TRF	1500	G, J, K	7.9/50	20@50MHz	160	1.95	310
NIN-HA1R8_TRF	1800	G, J, K	7.9/50	30@50MHz	160	2.25	310
NIN-HA2R2_TRF	2200	G, J, K	7.9/50	25@50MHz	130	2.41	310
NIN-HA2R7_TRF	2700	G, J, K	7.9/50	25@50MHz	110	2.85	300
NIN-HA3R0_TRF	3000	G, J, K	7.9/25	20@25MHz	110	3.12	300
NIN-HA3R9_TRF	3900	G, J, K	7.9/25	20@25MHz	60	3.6	290
NIN-HA4R7_TRF	4700	G, J, K	7.9/25	20@25MHz	60	4	280
NIN-HA5R6_TRF	5600	G, J, K	7.9/25	15@25MHz	50	5	250
NIN-HA6R8_TRF	6800	G, J, K	7.9	15@7.9MHz	40	8	230
NIN-HA8R6_TRF	8600	G, J, K	7.9	15@7.9MHz	40	9	200

Note: Extended values, tolerances, and enhanced versions are available please contact NIC for more details.



NIN-HB SERIES

B-SIZE (1812)

STANDARD VALUES

NIC P/N	INDUCTANCE VALUE (μH)	INDUCTANCE TOLERANCE	FREQUENCY L/Q(MHz)	Q FACTOR	SRF (MHz) Minimum	Rated DC Resistance (ohms)	Rated DC Current (mA)
NIN-HB1R0_TRF	1	G, J, K	7.9/50	60@50MHz	250	1.2	480
NIN-HB1R2_TRF	1.2	G, J, K	7.9/50	60@50MHz	230	1.2	480
NIN-HB1R5_TRF	1.5	G, J, K	7.9/50	60@50MHz	210	1.6	430
NIN-HB1R8_TRF	1.8	G, J, K	7.9/50	55@50MHz	150	2	380
NIN-HB2R2_TRF	2.2	G, J, K	7.9/50	55@50MHz	150	2.2	340
NIN-HB2R7_TRF	2.7	G, J, K	7.9/50	55@50MHz	150	3.2	300
NIN-HB3R3_TRF	3.3	G, J, K	7.9/50	55@50MHz	130	3.8	270
NIN-HB3R9_TRF	3.9	G, J, K	7.9/50	55@50MHz	120	5	240
NIN-HB4R7_TRF	4.7	G, J, K	7.9/50	55@50MHz	90	5.4	230
NIN-HB5R6_TRF	5.6	G, J, K	7.9/50	45@50MHz	90	5.7	220
NIN-HB6R8_TRF	6.8	G, J, K	7.9/50	30@50MHz	80	6.6	210
NIN-HB8R2_TRF	8.2	G, J, K	7.9/50	20@50MHz	70	7	200
NIN-HB100_TRF	10	G, J, K	7.9/50	15@50MHz	60	7.7	190
NIN-HB120_TRF	12	G, J, K	2.5/10	30@10MHz	50	8.7	180
NIN-HB150_TRF	15	G, J, K	2.5/10	30@10MHz	30	9.6	170
NIN-HB180_TRF	18	G, J, K	2.5/10	25@10MHz	30	10.5	160
NIN-HB220_TRF	22	G, J, K	2.5/10	25@10MHz	20	11.5	155
NIN-HB270_TRF	27	G, J, K	2.5/10	25@10MHz	20	12.5	150
NIN-HB330_TRF	33	G, J, K	2.5/10	10@10MHz	10	13.5	145

Note: Extended values, tolerances, and enhanced versions are available please contact NIC for more details.

PART NUMBER SYSTEM

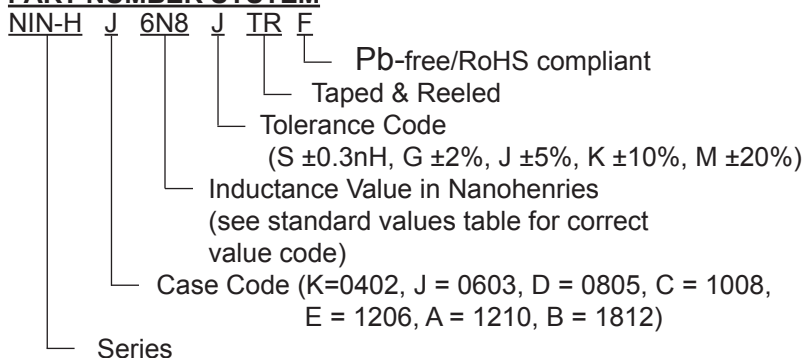

TAPE AND REEL DIMENSIONS (mm):

TYPE	A	B	C	W	Carrier Type	QTY/REEL
NIN-HK	0.67 ±0.05	0.66 ±0.05	1.20 ±0.05	8.0 ± 0.2	Punched	3,000
NIN-HJ	1.25 ±0.1	1.05 ±0.1	1.80 ±0.1	8.0 ± 0.2	Embossed	3,000
NIN-HD	1.60 ±0.1	1.25 ±0.1	2.50 ±0.1	8.0 ± 0.2	Embossed	2,000
NIN-HC	2.35 ±0.1	2.10 ±0.1	2.85 ±0.1	8.0 ± 0.2	Embossed	2,000
NIN-HE	2.40 ±0.1	1.90 max.	3.80 ±0.1	8.0 ± 0.2	Embossed	2,000
NIN-HA	2.96 ±0.1	2.80 max.	3.60 ±0.1	8.0 ± 0.2	Embossed	1,000
NIN-HB	3.61 ±0.1	3.81 max.	4.90 ±0.1	12.0 ± 0.2	Embossed	500

EMBOSSED PLASTIC CARRIER DIMENSIONS (mm)

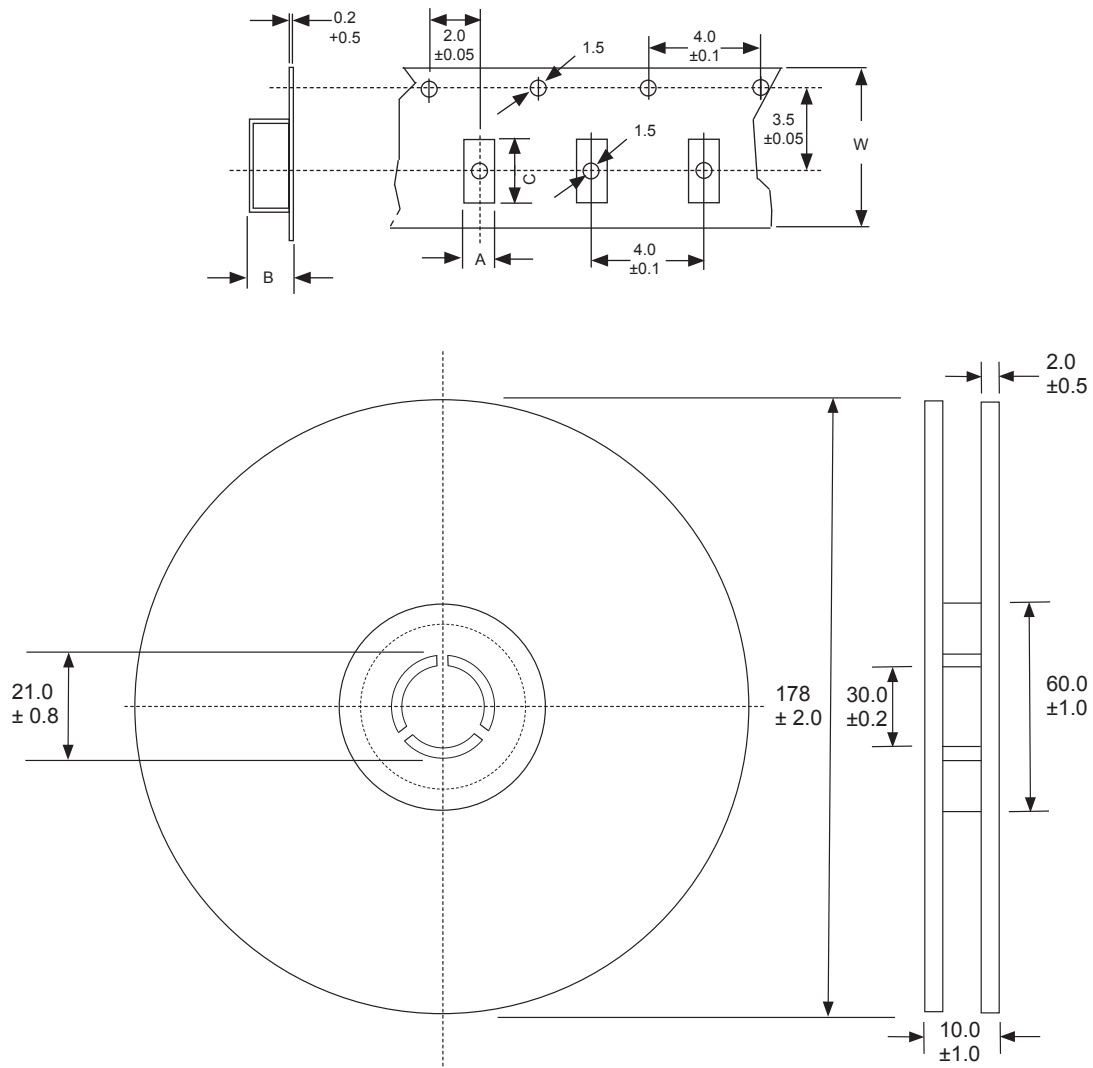

X-ON Electronics

Largest Supplier of Electrical and Electronic Components

Click to view similar products for [Multilayer Ceramic Capacitors MLCC - SMD/SMT](#) category:

Click to view products by [NIC](#) manufacturer:

Other Similar products are found below :

[M39014/01-1467](#) [M39014/02-1218V](#) [M39014/02-1225V](#) [M39014/02-1262V](#) [M39014/02-1301](#) [M39014/22-0631](#) [1210J5000102JCT](#)
[1210J2K00102KXT](#) [1210J5000103KXT](#) [1210J5000223KXT](#) [D55342E07B379BR-TR](#) [D55342E07B523DR-T/R](#) [1812J1K00103KXT](#)
[1812J1K00473KXT](#) [1812J2K00680JCT](#) [1812J4K00102MXT](#) [1812J5000102JCT](#) [1812J5000103JCT](#) [1812J5000682JCT](#) [NIN-FB391JTRF](#)
[NIN-FC2R7JTRF](#) [NPIS27H102MTRF](#) [C1206C101J1GAC](#) [C1608C0G1E472JT000N](#) [C2012C0G2A472J](#) [2220J2K00101JCT](#)
[KHC201E225M76N0T00](#) [LRC-LRF1206LF-01R025FTR1K](#) [1812J1K00222JCT](#) [1812J2K00102KXT](#) [1812J2K00222KXT](#)
[1812J2K00472KXT](#) [2-1622820-7-CUT-TAPE](#) [2220J3K00102KXT](#) [2225J2500824KXT](#) [CCR07CG103KM](#) [CGA2B2C0G1H010C](#)
[CGA2B2C0G1H040C](#) [CGA2B2C0G1H050C](#) [CGA2B2C0G1H060D](#) [CGA2B2C0G1H070D](#) [CGA2B2C0G1H151J](#) [CGA2B2C0G1H1R5C](#)
[CGA2B2C0G1H2R2C](#) [CGA2B2C0G1H3R3C](#) [CGA2B2C0G1H680J](#) [CGA2B2C0G1H6R8D](#) [CGA2B2X8R1H221K](#) [CGA2B2X8R1H472K](#)
[CGA3E1X7R1C474K](#)