

FEATURES

- GOLD INNER ELECTRODE FOR SUPERIOR ANTI-CORROSION PROPERTIES
- EIA STANDARD SIZING 0402, 0603, 0805, 1206, 1210, 2010 AND 2512
- SUIT FOR HIGH RELIABILITY APPLICATIONS IN HARSH ENVIRONMENTS
- ALL SIZES ARE AVAILABLE IN TAPE/REEL FOR AUTOMATIC MOUNTING
- SAC REFLOW SOLDERABLE (THREE TIMES AT 260°C FOR 10 SECONDS)

RoHS
Compliant
includes all homogeneous materials

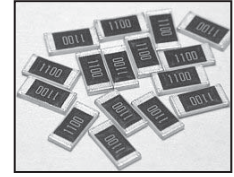

*See Part Number System for Details

SPECIFICATIONS

Type	EIA Size	Power Rating at 70°C	Max. *1 Working Voltage	Max. *2 Overload Voltage	Resistance Tolerance Code	Temperature Coefficient (ppm/°C)	Resistance Range (Ω)*3	Resistance Values	Operating Temperature Range
NRC-S04	0402	0.063W	50V	100V	±1%(F), ±2%(G), ±5%(J)	±200	10 ~ 1M	E-24 & E-96	-55°C ~ +155°C
						±350	3.9 ~ 9.1 1.1M ~ 22M		
						0 ~ +600	1.0 ~ 3.6		
NRC-S06	0603	0.10W	50V	100V	±1%(F), ±2%(G), ±5%(J)	±100	10 ~ 1M	E-24 & E-96	
						±200	10 ~ 1M	E-24	
						±350	1.0 ~ 9.1 1.1M ~ 22M	E-24 & E96	
NRC-S10	0805	0.125W	150V	300V	±1%(F), ±2%(G), ±5%(J)	±100	10 ~ 1M	E-24 & E-96	
						±200	10 ~ 1M	E-24	
						±250	3.9 ~ 9.1 1.1M ~ 5.1M	E-24 & E96	
						±350	1.0 ~ 3.6 5.6M ~ 22M	E-24 & E96	
NRC-S12	1206	0.25W	200V	400V	±1%(F), ±2%(G), ±5%(J)	±100	10 ~ 1M	E-24 & E-96	
						±200	10 ~ 1M	E-24	
						±250	3.9 ~ 9.1 1.1M ~ 5.1M	E-24 & E96	
NRC-S25	1210	0.25W	200V	400V	±1%(F), ±2%(G), ±5%(J)	±350	1.0 ~ 3.6 5.6M ~ 22M	E-24 & E96	
						±100	10 ~ 1M	E-24 & E-96	
						±200	10 ~ 1M	E-24	
NRC-S50	2010	0.50W	200V	400V	±1%(F), ±2%(G), ±5%(J)	±250	3.9 ~ 9.1	E-24 & E96	
						±350	1.0 ~ 3.6	E-24 & E96	
						±100	10 ~ 1M	E-24 & E-96	
NRC-S100	2512	1.0W	200V	400V	±1%(F), ±2%(G), ±5%(J)	±200	10 ~ 1M	E-24	
						±250	2.2 ~ 9.1	E-24 & E96	
						±350	1.0 ~ 2.0	E-24 & E96	
						±100	10 ~ 1M	E-24 & E-96	
NRC-S100	2512	1.0W	200V	400V	±1%(F), ±2%(G), ±5%(J)	±200	10 ~ 1M	E-24	
						±250	2.2 ~ 9.1	E-24 & E96	
						±350	1.0 ~ 2.0	E-24 & E96	

Note *1 - Maximum allowable continuous Working Voltage for all resistors is the lower of the two values:

"Maximum Working Voltage" as specified above or the result of the following formula

$$\sqrt{\text{Power rating (Watts)} \times \text{Resistance (Ohms)}}$$

Note *2 - "Maximum Overload Voltage" for all resistors is the lower of the two values:

"Maximum Overload Voltage" as specified above or 2x the result of the following formula

$$\sqrt{\text{Power rating (Watts)} \times \text{Resistance (Ohms)}}$$

Note *3 - 11Meg ~ 22Meg only available in E-24 values

Power Derating Curve: For operation above 70°C, power rating must be derated according to the following chart:

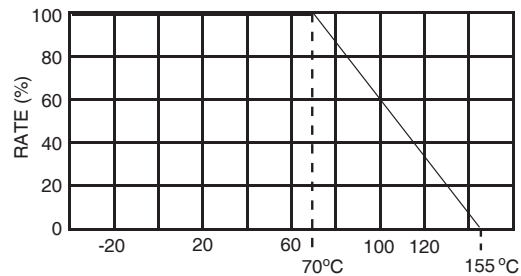

ZERO OHM JUMPER RATINGS

Jumper	EIA Size	Power Rating at 70°C	Current Rating	Overload Current Rating	Maximum Resistance	Operating Temperature Range
NRC-S04ZO	0402	0.063W	1.0A	2.0A	50mΩ	-55°C ~ +155°C
NRC-S06ZO	0603	0.10W	1.0A	2.0A		
NRC-S10ZO	0805	0.125W	2.0A	4.0A		
NRC-S12ZO	1206	0.25W				
NRC-S25ZO	1210	0.25W				
NRC-S50ZO	2010	0.50W				
NRC-S100ZO	2512	1.0W	2.5A	5.0A		

Typical Performance*
(After immersions in cutting fluid with 0.5% Sulfur content)

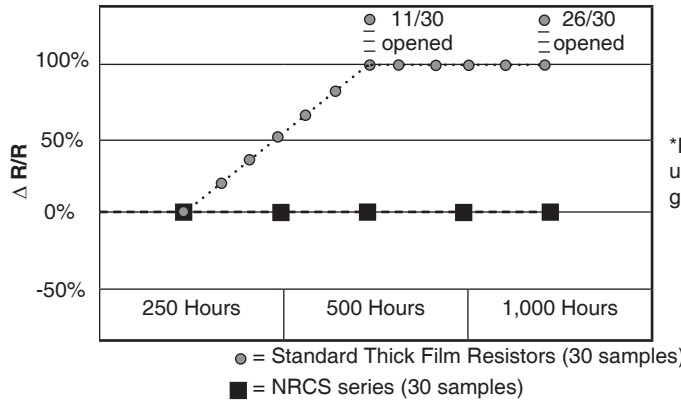

*Referential performance measured under certain preconditions and not guaranteed.

PART NUMBER SYSTEM (E-24 VALUES)

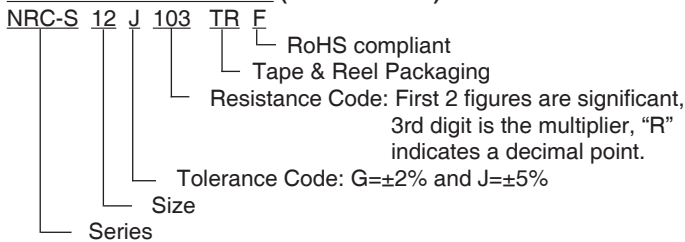

PART NUMBER SYSTEM (E-96 VALUES)

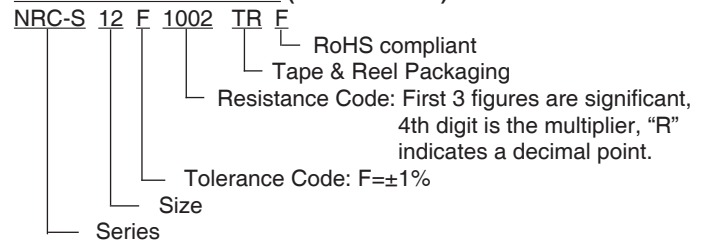

DIMENSIONS (mm)

Type	EIA Size	L	W	H	T	t
NRC-S04	0402	1.0 ± 0.05	0.50 ± 0.05	0.35 ± 0.05	0.2 ± 0.1	0.25 ^{+0.06} _{-0.05}
NRC-S06	0603	1.60 ± 0.15	0.80 ± 0.15	0.45 ± 0.10	0.30 ± 0.20	0.30 ± 0.20
NRC-S10	0805	2.00 ± 0.20	1.25 ± 0.10	0.50 ± 0.10	0.40 ± 0.20	0.40 ± 0.20
NRC-S12	1206	3.20 ^{+0.06} _{-0.05}	1.60 ^{+0.05} _{-0.15}	0.60 ± 0.10	0.50 ± 0.25	0.50 ± 0.20
NRC-S25	1210	3.2 ± 0.20	2.50 ^{+0.2} _{-0.1}	0.60 ± 0.10	0.50 ± 0.25	0.50 ± 0.20
NRC-S50	2010	5.0 ± 0.2	2.5 ± 0.15	0.6 ± 0.1	0.6 ± 0.2	0.5 ± 0.3
NRC-S100	2512	6.3 ± 0.2	3.2 ± 0.2	0.6 ± 0.1	0.7 ± 0.2	0.7 ± 0.2

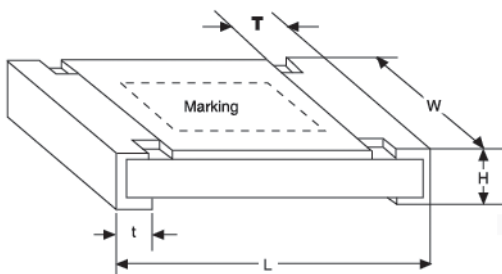

CONSTRUCTION

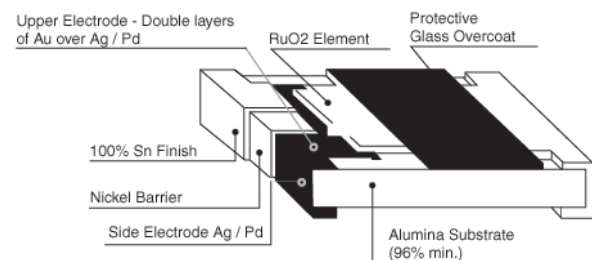

STANDARD E-12, E-24, E-96 VALUES AND 0603 RESISTANCE CODES

E-12		E-24		E-96									
Value		Value		Value	Code		Value	Code		Value	Code	Value	Code
10		100		100	01		102	02		105	03	107	04
12		110		110	05		113	06		115	07	118	08
15		120		121	09		124	10		127	11	130	12
18		130		133	13		137	14		140	15	143	16
22		150		147	17		150	18		154	19	158	20
27		160		162	21		165	22		169	23	174	24
33		180		178	25		182	26		187	27	191	28
39		200		196	29		200	30		205	31	210	32
47		220		215	33		221	34		226	35	232	36
56		240		237	37		243	38		249	39	255	40
68		270		261	41		267	42		274	43	280	44
82		300		287	45		294	46		301	47	309	48
91		330		316	49		324	50		332	51	340	52
		360		348	53		357	54		365	55	374	56
		390		383	57		392	58		402	59	412	60
		430		422	61		432	62		442	63	453	64
		470		464	65		475	66		487	67	499	68
		510		511	69		523	70		536	71	549	72
		560		562	73		576	74		590	75	604	76
		620		619	77		634	78		649	79	665	80
		680		681	81		698	82		715	83	732	84
		750		750	85		768	86		787	87	806	88
		820		825	89		845	90		866	91	887	92
		910		909	93		931	94		953	95	976	96

CARRIER TAPE DIMENSIONS (mm)

Type	EIA Case Size	Carrier Material	A	B	W	F	E	P ₁	P ₂	P ₀	D ₀	t ₂	t ₁
NRC-S04	0402	Paper	0.65 ±0.10	1.15 ±0.10	8.0 ±0.20	3.50 ±0.05	1.75 ±0.05	2.00 ±0.05	n/a	4.00 ±0.10	1.50 ^{+0.10} ₀	1.00 max.	0.5 max
NRC-S06	0603		1.10 ±0.20	1.90 ±0.20				4.00 ±0.10	2.00 ±0.05				1.0 max.
NRC-S10	0805		1.65 ±0.20	2.40 ±0.20				1.0 max.					
NRC-S12	1206		2.00 ±0.20	3.50 ±0.20				1.0 max.					
NRC-S25	1210		2.85 ±0.20	3.50 ±0.20				1.0 max.					
NRC-S50	2010	Embossed Plastic	2.90 ±0.20	5.40 ±0.20	12.0 ±0.20	5.50 ±0.05						1.10 max.	0.25 max
NRC-S100	2512		3.40 ±0.20	6.60 ±0.20									

PAPER CARRIER

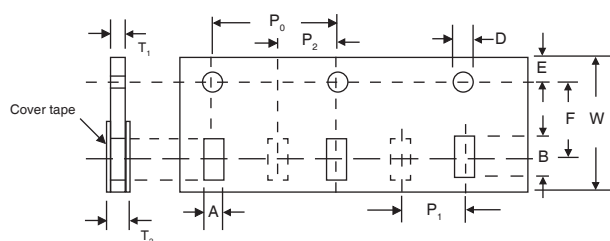

EMBOSSED PLASTIC CARRIER

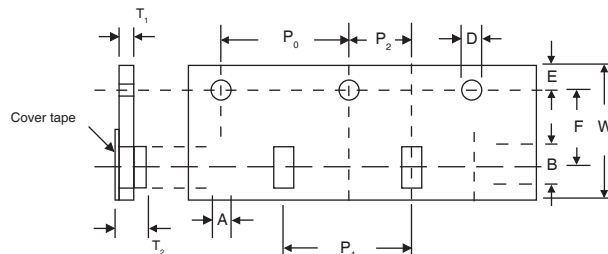

REEL DIMENSIONS (mm)

Type	EIA Case Size	A	B	C	D	E	W	Qty
NRC-S04	0402	180 <small>+0.0 -3.0</small>	60 <small>+1.0 -3.0</small>	13.0 <small>±0.20</small>	21.0 <small>±0.80</small>	2.0 <small>±0.50</small>	9.00 <small>±0.30</small>	10,000
NRC-S06	0603							5,000
NRC-S10	0805							
NRC-S12	1206							
NRC-S25	1210							
NRC-S50	2010						4,000	
NRC-S100	2512							13.0 <small>±0.30</small>

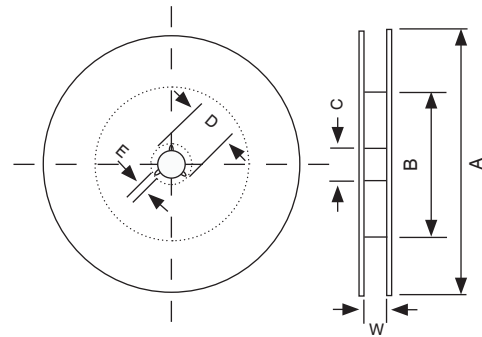

LAND PATTERN DIMENSIONS (mm)

Type	EIA Case Size	A	B	C
NRC-S04	0402	0.5	1.3	0.5
NRC-S06	0603	0.9	2.6	0.7
NRC-S10	0805	1.35	3.45	1.1
NRC-S12	1206	2.2	4.7	1.4
NRC-S25	1210	2.2	5.2	2.15
NRC-S50	2010	3.7	6.2	2.15
NRC-S100	2512	4.7	7.6	2.75

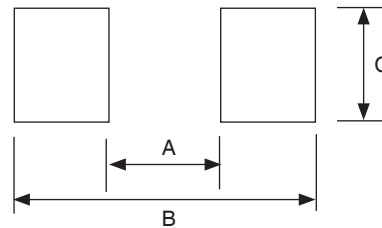

REFLOW SOLDERING TEMPERATURE PROFILE

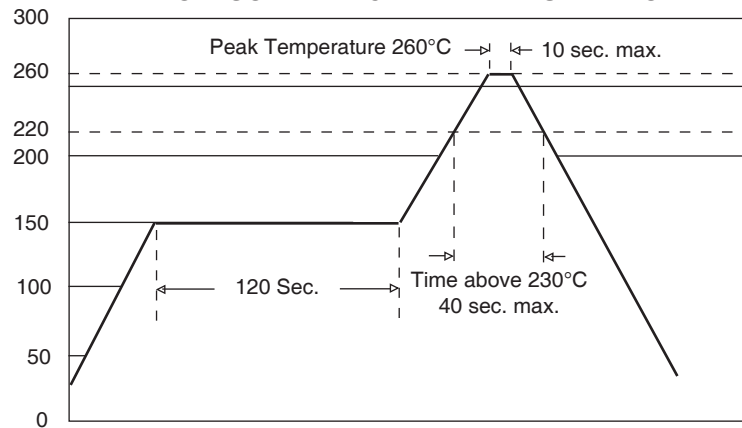

X-ON Electronics

Largest Supplier of Electrical and Electronic Components

Click to view similar products for [Thick Film Resistors - SMD category](#):

Click to view products by [NIC manufacturer](#):

Other Similar products are found below :

[CRCW04028R20JNEE](#) [CRCW06036K80FKEE](#) [CRG1206F1K58](#) [CRL0603-FW-R700ELF](#) [M55342K06B6E19RWL](#) [RC1005F1072CS](#)
[RC1005F471CS](#) [RC1005F4751CS](#) [RCP0603W100RGED](#) [RCWP72251K47FKWB](#) [RLR05C7501GPB14](#) [RLR07C5111FSBSL](#) [ERJ-](#)
[1GMF1R00C](#) [ERJ-1GMF1R20C](#) [ERJ-1GMF2R55C](#) [ERJ-1GMF8R66C](#) [25121WF1003T4E](#) [25.501.3653.0](#) [290-1.0M-RC](#) [292-1.0M-RC](#) [292-](#)
[2.2K-RC](#) [292-4.7K-RC](#) [25121WF4700T4E](#) [292-470K-RC](#) [302-1.0M-RC](#) [CPG1206F10KC](#) [CRCW02011R00FXED](#) [CRCW060315K0FKEE](#)
[CRCW060320K5FKEE](#) [CRG0201F10K](#) [RCG0402150RFKED](#) [RCG04023K92FKED](#) [RCP2512B100RGWB](#) [RCWP110010R0FKS3](#)
[RCWP11002K00FKS3](#) [RCWP12061K00FKS2](#) [3520510RJT](#) [352075KJT](#) [M55342K11B9E53RUL](#) [RMC16-102JT](#) [RMC1JPTE](#) [TR0603MR-](#)
[075K1L](#) [5-2176094-4](#) [35202K7JT](#) [WF06Q1000FTL](#) [ERJ-S03J1R0V](#) [ERJ-S14J4R7U](#) [CHP2512L4R30GNT](#) [CPCC10270R0JE32](#)
[WR12X1621FTL](#)