





Shanghai
Nicera



Pyroelectric Sensor 热释电红外传感器

上海尼赛佳传感器有限公司
www.china-sns.com

规格 Type

灵敏元型号 Element Type	标准式样 Recommended Model	特点 Features	用途 Applications
单元补偿型 Compensated Single	PM611 	从任意的角度探测入侵。 补偿元可以克服快速的环境变化。	<ul style="list-style-type: none"> ● 人体探测 ● 火灾探测 ● 气体分析 ● 辐射测温 ● 微波炉
		Detection from any angle of intrusion. Compensating element cancels the effects of rapid change in temperature.	<ul style="list-style-type: none"> ● Human body detector ● Flame detector ● NDIR gas detector ● Radiation thermometer ● Microwave oven
双元型 Dual	SDA02-54 (PD632) 	最适合做人体探测。 采用双元补偿结构，在保证高灵敏探测人体的同时，对环境温度变化，振动、杂散乱光等不敏感。	<ul style="list-style-type: none"> ● 防盗报警用入侵探测器 ● 空调用人体探测器
		Best choice for human body detector. Highly sensitive to human body while remaining insensitive to ambient temperature change, vibration or optical noise. This is due to configuration which electrically cancels such effects.	<ul style="list-style-type: none"> ● Security burglar alarm ● Air-conditioner
四元型 Quad	REP05B 	两个独立的双元热释电传感器封装在一起。 通过适当的光学探测区组合可以极大地减少小动物误报，对外部杂散乱光等噪声有较高的抑制。	<ul style="list-style-type: none"> ● 防盗报警用入侵探测器 (减少小动物误报)
		Two independent dual element pyrosensors in combination. By using appropriate optics nuisance alarm from sources such as small animals are much reduce. Provides higher rejection against external noise.	<ul style="list-style-type: none"> ● Security burglar alarm (To avoid false alarm by small animals nuisance alarm)
无方向性 Omni-directional Quad	RE46B 	特殊的四元结构实现无方向性探测。 结合单元、双元的优点，对头、手的微小动作有较高的监测能力。	<ul style="list-style-type: none"> ● 防盗报警用入侵探测器 (吸顶式) ● 自动照明开关
		Omni directional characteristics is achieved by unique 4 element configuration. Technical merits of single and dual type have successfully met on this model.	<ul style="list-style-type: none"> ● Security burglar alarm (For ceiling mount applications) ● Automatic lighting switches



规格 Type

灵敏元型号 Element Type	标准式样 Recommended Model	特点 Features	用途 Applications
常用型 General Purpose Dual	RE200B (KP500B-P) 	普通常用型号。 这个型号在保证合理的性能的同时，满足客户 缩减成本的需求。	<ul style="list-style-type: none"> ● 自动照明开关 ● 防盗报警用入侵探测器 ● 玩具
		This model satisfies customer's cost reduction need, keeping most performance of dual element type at reasonable level.	<ul style="list-style-type: none"> ● Automatic lighting switches ● Security burglar alarm ● Toys
高感度四元型 High Sensitivity 4 elements Dual	RE431B 	高灵敏四元。 具有高的信噪比和大的角度，理想的敏感元图 案提供优秀的人体探测效果。	<ul style="list-style-type: none"> ● 防盗报警用入侵探测器 ● 自动照明开关
		A new dual type with high sensitivity and S/N ratio and wide field of view. Excellent human body detection is achieved by optimal element pattern.	<ul style="list-style-type: none"> ● Security burglar alarm ● Automatic lighting switches
大窗口常用型 Wide Field Of View	RE03B (KP506B) 	大窗口常用型号。 这个型号在保证合理的性能的同时，满足客户 缩减成本的需求。	<ul style="list-style-type: none"> ● 防盗报警用入侵探测器 ● 自动照明开关
		Wide Field Of View. This model satisfies customer's cost reduction need, keeping most performance of dual element type at reasonable level.	<ul style="list-style-type: none"> ● Security burglar alarm ● Automatic lighting switches

本公司可以根据客户要求，提供特殊要求产品，如提高抗射频干扰，引线加长、镀金等定制

Option for specific products required by customers such as increased radio frequency interference, extended wiring or gold plating.

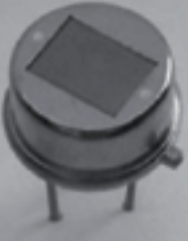
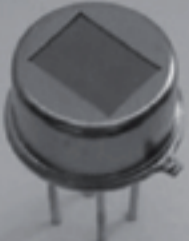
视野角 外形尺寸 等价电路 FOV Dimension Equivalent Circuit

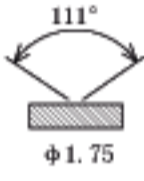
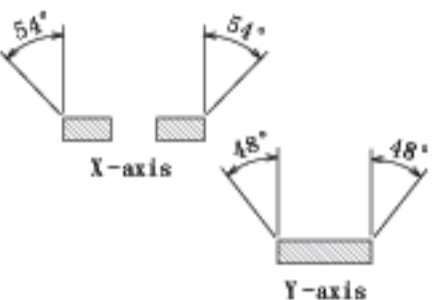
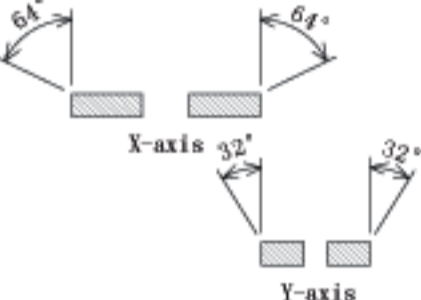
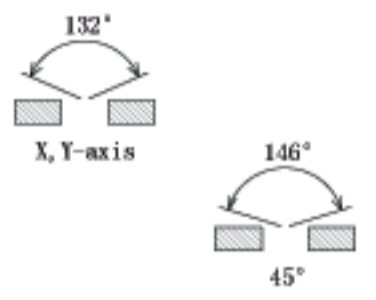
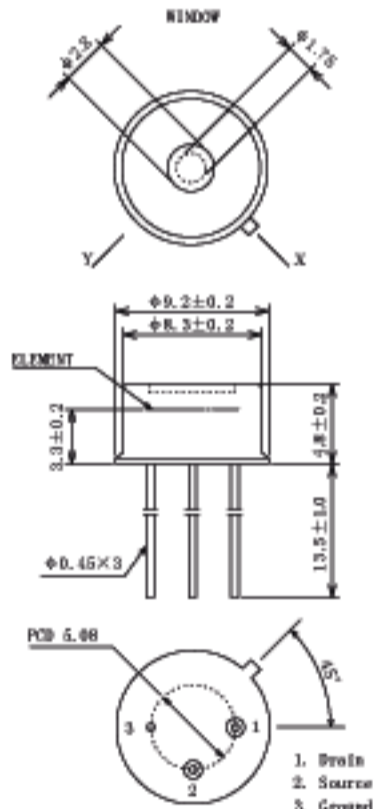
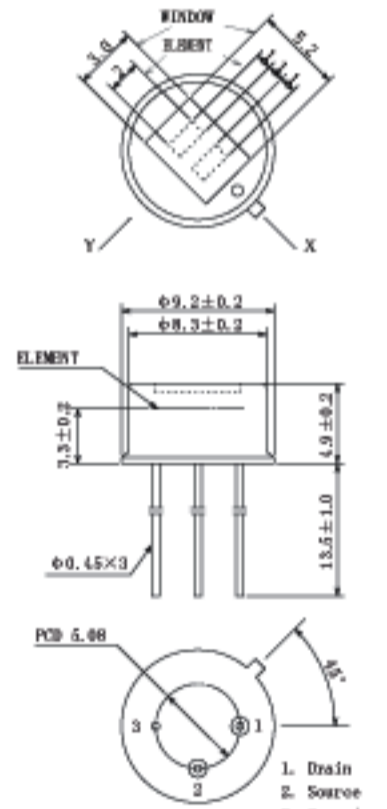
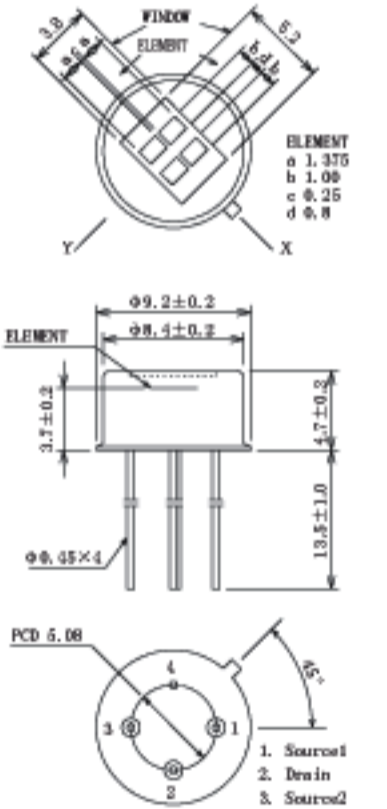
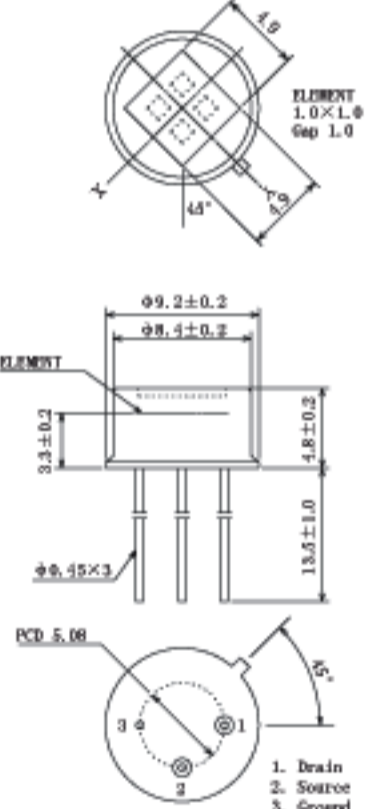
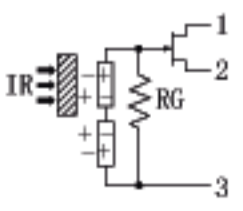
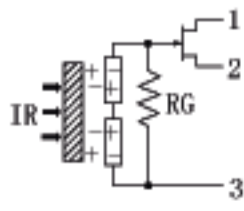
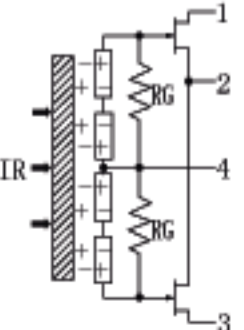
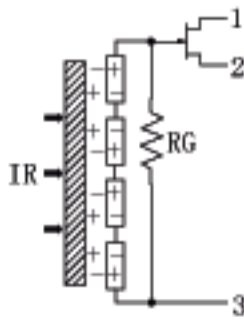
单元补偿型 Compensated Single	双元型 Dual	四元型 Quad	无方向性 Omni-directional Quad
<p>PM611</p> 	<p>SDA02-54 (PD632)</p> 	<p>REP05B</p> 	<p>RE46B</p> 
视野角 FOV			
 <p>111° φ1.75</p>	 <p>54° 54° X-axis 48° 48° Y-axis</p>	 <p>64° 64° X-axis 32° 32° Y-axis</p>	 <p>132° X, Y-axis 45°</p>
外形尺寸 Dimensions Drawing (mm)			
 <p>WINDOW φ2.5 φ1.75 Y X ELEMENT φ9.2±0.2 φ8.3±0.2 3.3±0.2 4.8±0.2 φ0.45×3 13.5±1.0 PCD 5.08 5° 1. Drain 2. Source 3. Ground</p>	 <p>WINDOW ELEMENT 3.0 5.2 Y X ELEMENT φ9.2±0.2 φ8.3±0.2 3.3±0.2 4.9±0.2 φ0.45×3 13.5±1.0 PCD 5.08 5° 1. Drain 2. Source 3. Ground</p>	 <p>WINDOW ELEMENT 3.9 5.2 Y X ELEMENT a 1.375 b 1.08 c 0.25 d 0.8 φ9.2±0.2 φ8.4±0.2 3.7±0.2 4.7±0.2 φ0.45×4 13.5±1.0 PCD 5.08 5° 1. Source1 2. Drain 3. Source2 4. Ground</p>	 <p>WINDOW ELEMENT 4.9 4.9 Y X ELEMENT 1.0×1.0 Gap 1.0 φ9.2±0.2 φ8.4±0.2 3.3±0.2 4.8±0.2 φ0.45×3 13.5±1.0 PCD 5.08 5° 1. Drain 2. Source 3. Ground</p>
等价电路 Equivalent Circuit			
 <p>IR RG 1 2 3</p>	 <p>IR RG 1 2 3</p>	 <p>IR RG 1 2 4 3</p>	 <p>IR RG 1 2 3</p>

视野角 外形尺寸 等价电路 FOV Dimension Equivalent Circuit

可靠性试验 Reliability Standard

试验项目 Test Item	试验条件 Test Conditions	规格 Criteria
耐湿性 Humidity	60 ℃, 95%, 500小时 60 ℃, 95%, for 500Hr	试验完毕后，常温放置2小时，测定感度、杂音。相对初期测定值，变化值在±20%以内。外观无显著损伤。 Within ±20% of initial value with naturally normalized at room temperature for 2Hr.No remarkable damage.
高温负荷寿命 High Temperature Loading	85 ℃, 施加5V电压，接负荷电阻47KΩ, 1000小时 85 ℃, 5V applied, 47kΩ load,1000Hr	
低温放置 Low Temperature	-40 ℃, 1000小时 -40 ℃, for 1000Hr	
热循环 Heat Shock	-10 ℃, 30分钟←→50 ℃, 30分钟为1个循环，共100个循环 -10 ℃, 30min←→50 ℃, 30min × 100 cycles	
振动 Vibration	频率变化：10Hz-55Hz 全振幅：1.5mm 扫描sweep比例：10-55-10Hz 加振时间：3轴方向2小时 Apply vibration of amplitude of 1.5mm with 10 to 55Hz band to each of 3 perpendicular directions for 120min.	
端子拉力强度 Lead Strength	在轴方向上施加1Kg的张力，保持5秒钟 1kg strain force along lead, 5sec	
焊锡耐热性 Soldering Heat	260±5 ℃, 10±1秒，浸润到离引脚根部1.5 mm 处 260±5 ℃, 10±1sec. Dipping leads submerge into solder down to 1.5 mm below stem.	
气密性 Hermetic Seal	水中160mmHg，浸润1分钟 160mmHg water, 1min	不产生气泡 No bubble visible

测定方法 Measuring Method

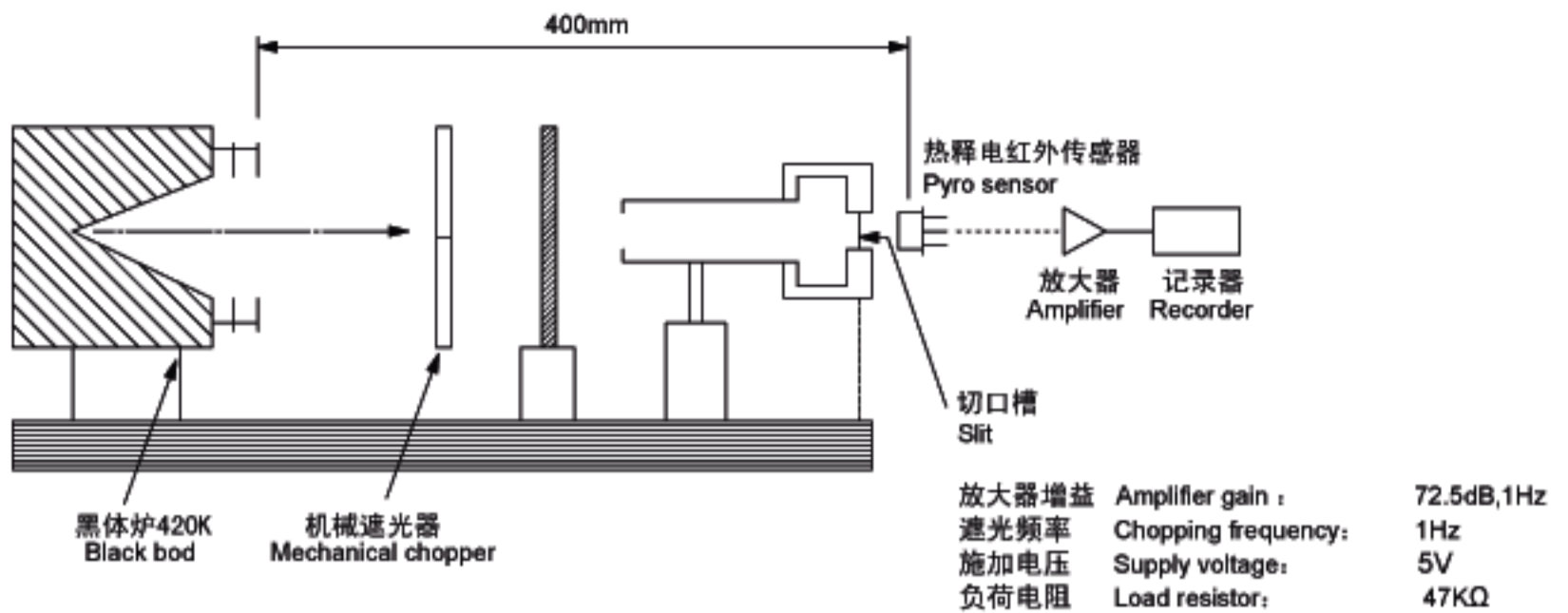

放大器频率特性 Frequency response of amplifier

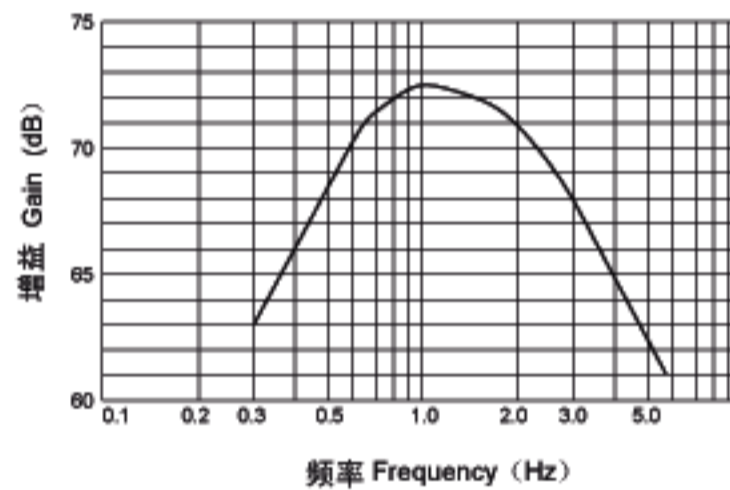

频率特性 Frequency Characteristics

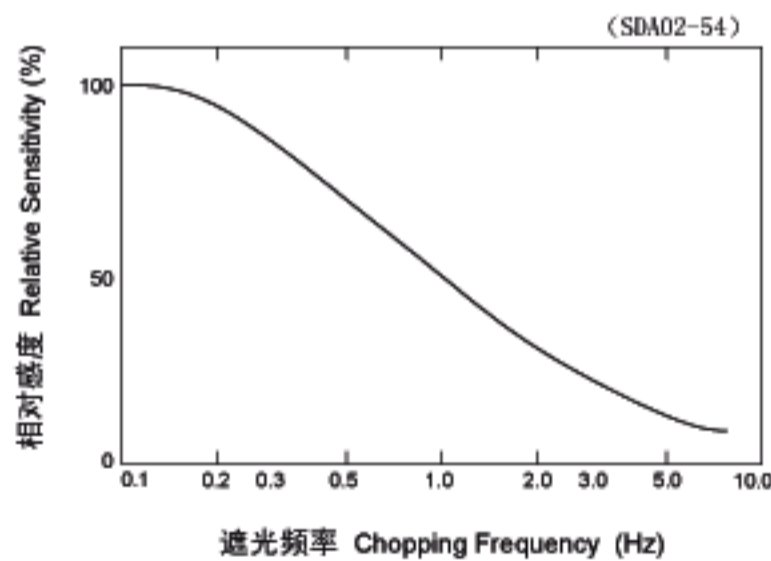

频率特性 Typical signal of dual element detector

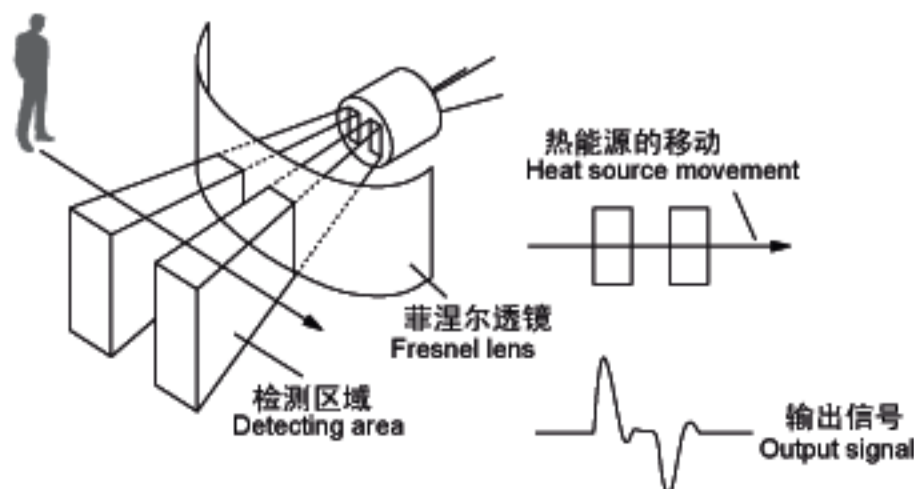

规格 Type

光学滤光片 Filter	主要用途 Applications
硅片 Silicon	温度计测 Temperature measurement
4.3 μm 带通 (Band-pass)	火焰检测 Flame detection
5.0 μm 长通 (Long-pass)	人体检测 Human body detection
6.5 μm 长通 (Long-pass)	安保 Security
3-5 μm 反射防止膜 (AR coated)	反射防止膜用于减少滤光材料表面反射 AR-coating is used to reduce the surface reflection of filter material.

※ AR : Anti-Reflection coating (反射防止膜)

波长透过性 Spectral Response of Window Materials

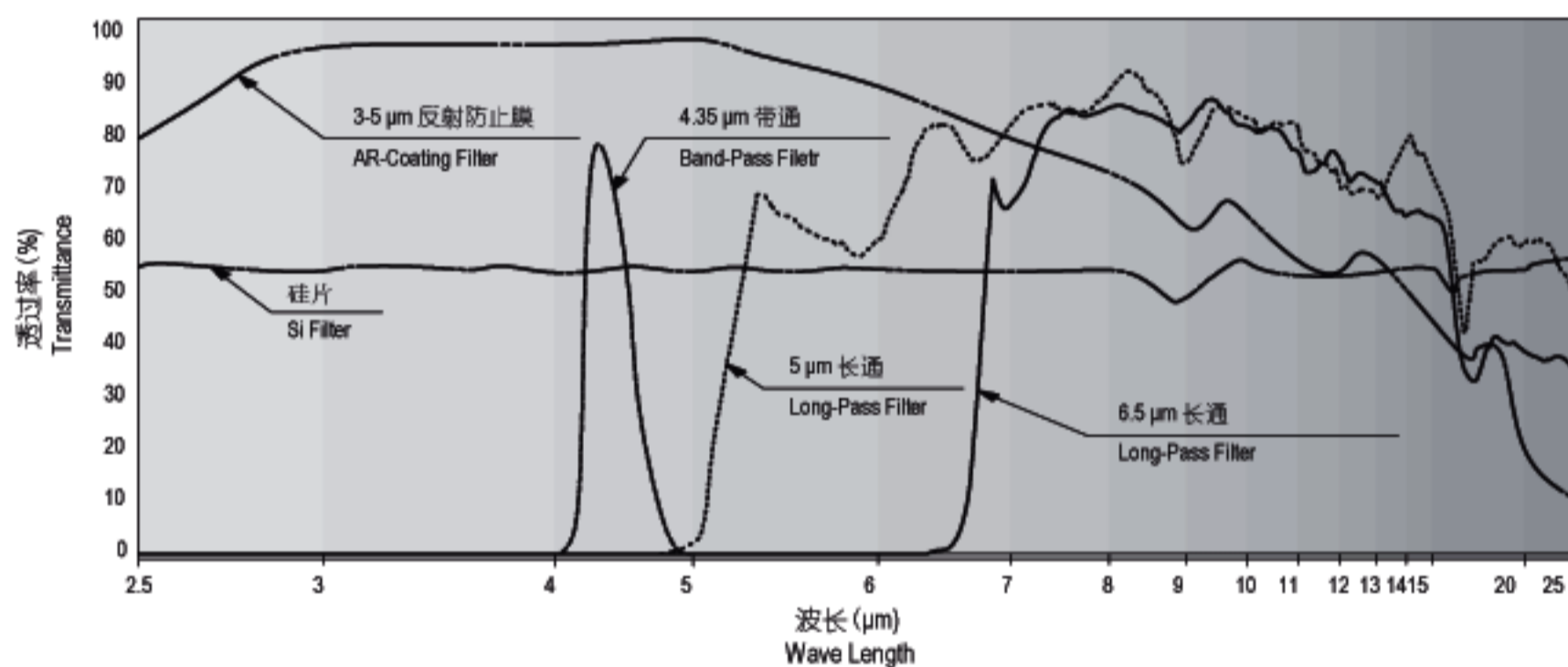

使用菲涅尔透镜可决定传感器的检测范围和检测距离。根据客户的要求，可以对应各种检测范围、检测距离。

To determine detection range and area. Custom designs are available for various coverage patterns and detection range.

NL-3

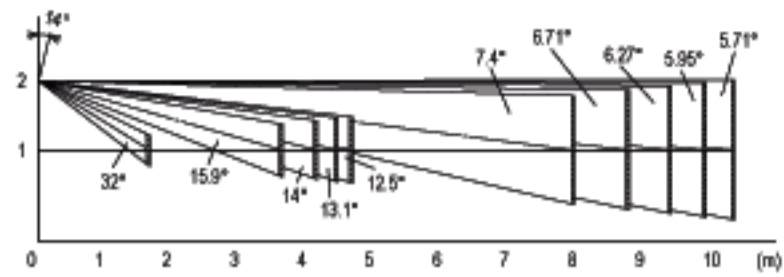
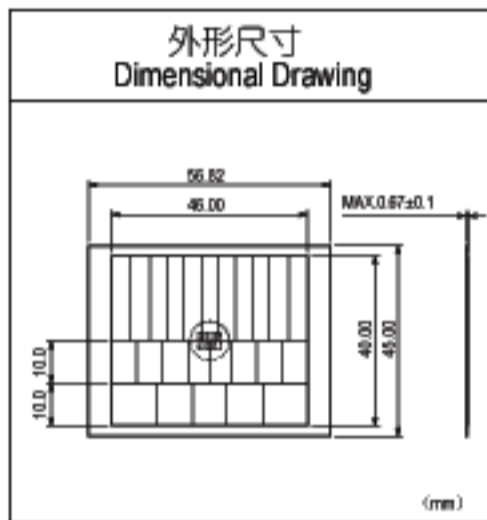
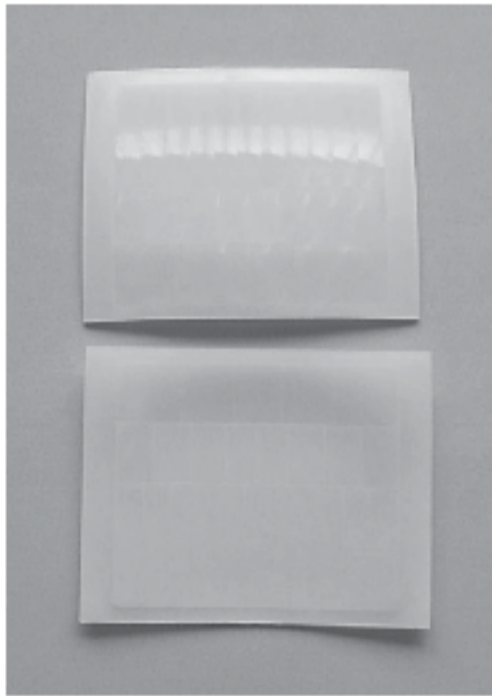

垂直视场图
Vertical View Pattern

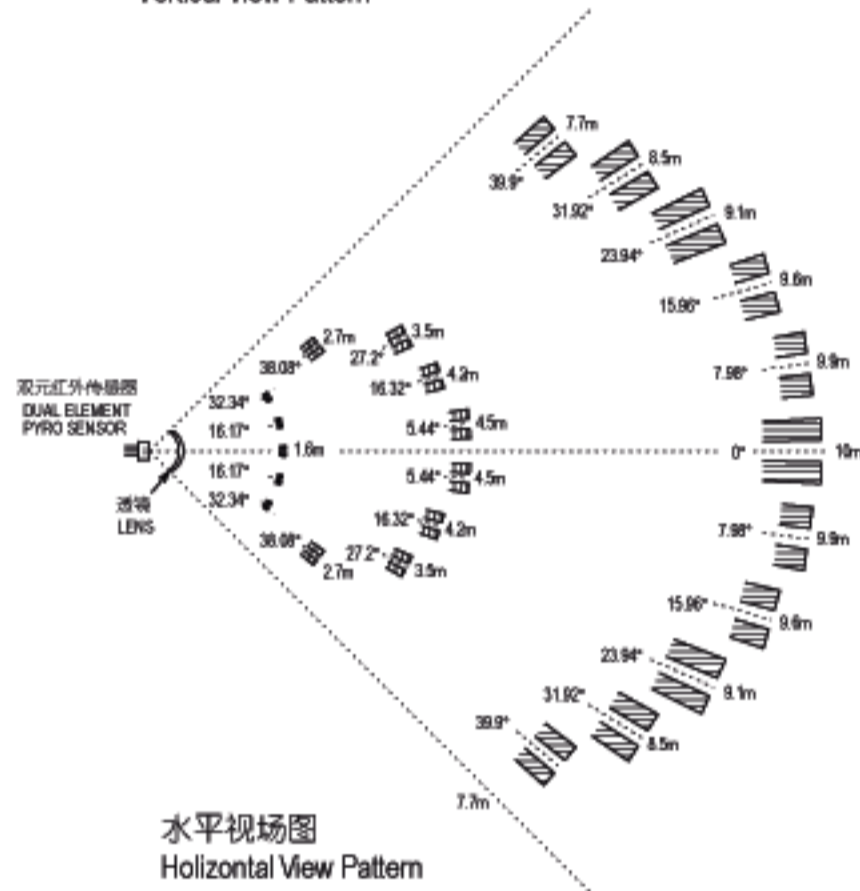

水平视场图
Horizontal View Pattern

NL-11

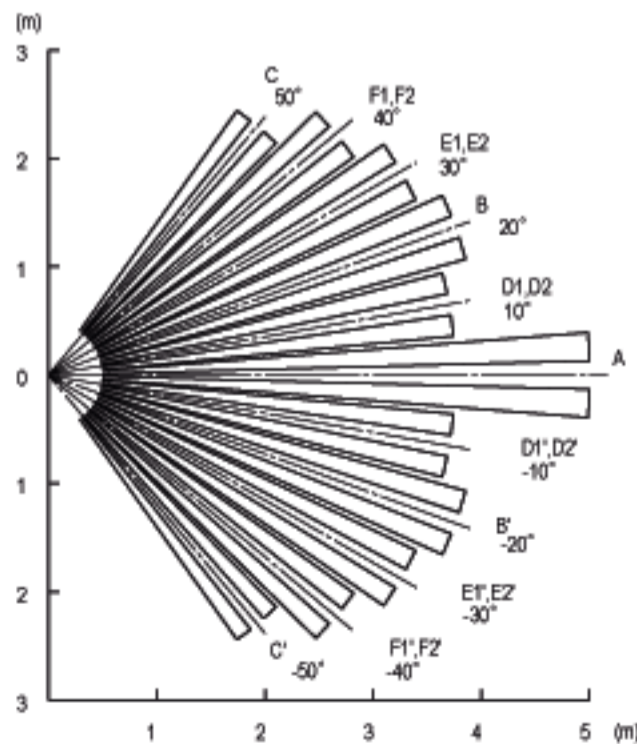
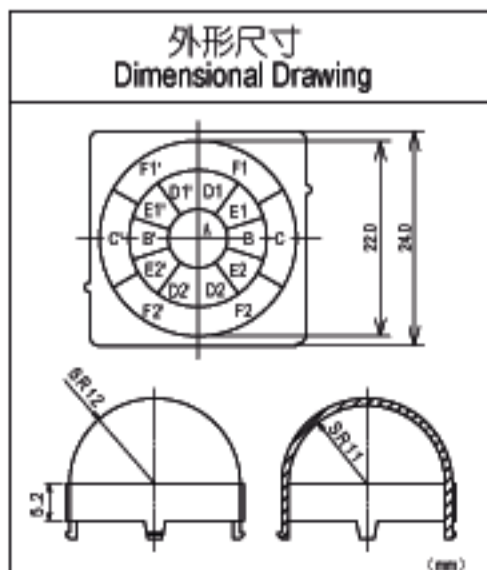

水平视场图
Horizontal View Pattern

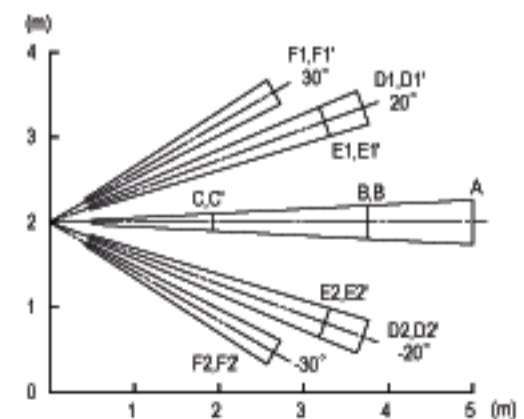

垂直视场图
Vertical View Pattern

X-ON Electronics

Largest Supplier of Electrical and Electronic Components

Click to view similar products for [Phototransistors](#) category:

Click to view products by [Nicera](#) manufacturer:

Other Similar products are found below :

[LTR-5576D](#) [QSD123A4R0](#) [ASDL-6620-C22](#) [OED-ST-8LR2](#) [OED-STR44B90-TR](#) [SD5410-109](#) [PT91-21C/TR7](#) [SFH 3410 -1/2](#) [PT91-21C/TR10](#) [ZPT-1608C-08-Z3](#) [BP 103-3/4](#) [BPY 62](#) [KPS-3227SP1C](#) [L-53P3BT](#) [L-53P3C](#) [L-93DP3BT](#) [L-93DP3C](#) [LL-503PTC2E-1AD](#) [LL-S150PTC-1A](#) [LL-S150PTD-1A](#) [SCM-014TBT86](#) [SFH 309-56](#) [SFH 320](#) [SFH 320 FA](#) [SFH 320-Z](#) [OP508FA](#) [TEMT1030](#) [LTR-301](#) [PGM5516](#) [PGM5516-MP](#) [PGM5526-MP](#) [PGM5537-MP](#) [PGM5637D](#) [PGM5639D](#) [VTT7125H](#) [KPA-3010P3C](#) [VEMT4700F-GS08](#) [OP830WSL](#) [PT19-21B/L41/TR8](#) [KP-2012P3C](#) [TEKT5400S](#) [RPT-37PB3F](#) [RPM-075PTT86](#) [SD1410-128L](#) [SFH 320 FA-4-Z](#) [SFH 313 FA-3/4](#) [SFH 313 FA-2/3](#) [SFH 320-4-Z](#) [SFH 309 FA-5/6](#) [SFH 309-5/6](#)