

# RL8 Low ESR, Low Profile (φ8)

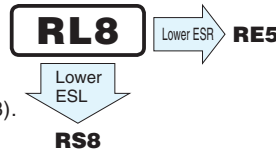

FPCAP

- Ultra Low ESR, High ripple current.
- Low Profile(Height 8mm).
- Load life of 2000/5000 hours at 105°C.
- Radial lead type : Lead free flow soldering condition correspondence.
- Compliant to the RoHS directive (2011/65/EU,(EU)2015/863).



## Specifications

Item	Performance Characteristics	
Category Temperature Range	-55 to +105°C	
Rated Voltage Range	2.5 to 35V	
Rated Capacitance Range	100 to 1500μF	
Capacitance Tolerance	±20% at 120Hz, 20°C	
Tangent of loss angle (tan δ)	Less than or equal to the specified value at 120Hz, 20°C	
ESR (※1)	Less than or equal to the specified value at 100kHz, 20°C	
Leakage Current (※2)	Less than or equal to the specified value. After 2 minutes' application of rated voltage at 20°C	
Endurance	Test condition	105°C, rated voltage 2000 / 5000Hrs.
	Capacitance change	Within ±20% of initial value before test
	tan δ	150% or less than the initial specified value
	ESR(※1)	150% or less than the initial specified value
	Leakage current (※2)	Less than or equal to the initial specified value

※1 ESR should be measured at both of the terminal ends closest to the capacitor body.

※2 Conditioning : If any doubt arises, measure the leakage current after the voltage treatment of applying DC rated voltage continuously to the capacitor for 120 minutes at 105°C.

## Dimensions

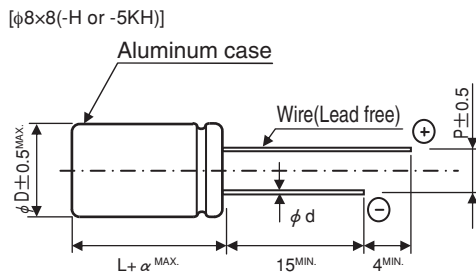
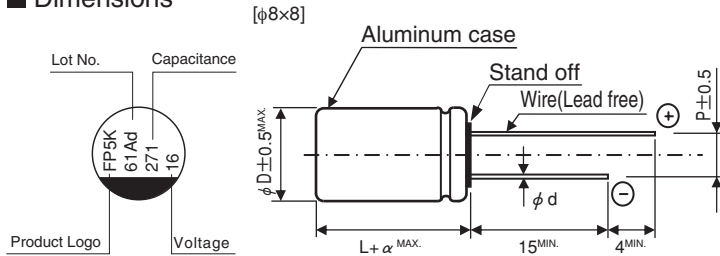

(mm)			
φD×L	φd	P	α
8×8	0.6	3.5	1.0

### Frequency coefficient of rated ripple current

Frequency	120 Hz	1 kHz	10 kHz	100 kHz	300 kHz
Coefficient	0.10	0.45	0.50	1.00	1.00

## Type numbering system (Example : 16V 270μF) Nichicon part number

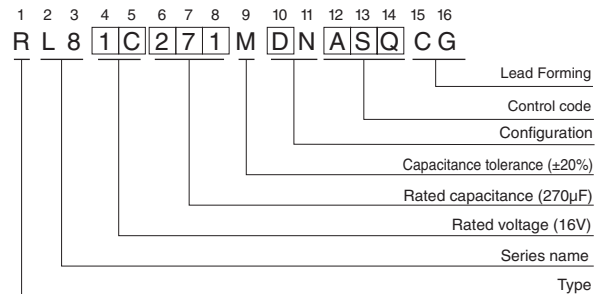

## FPCAP part number

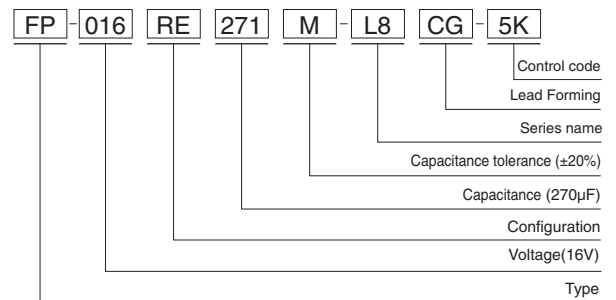

# RL8

■ Dimensions

Rated Voltage (V) (code)	Surge Voltage (V)	Rated Capacitance (μF)	Case Size φD×L (mm)	tan δ	Leakage Current (μA) (at 20°C after 2 minutes)	ESR (mΩ) (20°C/100kHz)	Rated Ripple Current (mA <sub>rms</sub> ) (105°C/100kHz)	NICHICON	FPCAP
2.5 (0E)	2.8	560	8×8	0.12	500	6	6100	RL80E561MDN1□□	FP-2R5RE561M-L8□□
		560	8×8	0.12	500	6	6100	RL80E561MCN1□□	FP-2R5RE561M-L8□□-H
		* 560	8×8	0.12	500	6	6100	RL80E561MDNASQ□□	FP-2R5RE561M-L8□□-5K
		* 560	8×8	0.12	500	6	6100	RL80E561MCNASQ□□	FP-2R5RE561M-L8□□-5KH
		820	8×8	0.12	513	6	6100	RL80E821MDN1□□	FP-2R5RE821M-L8□□
		820	8×8	0.12	513	6	6100	RL80E821MCN1□□	FP-2R5RE821M-L8□□-H
		* 820	8×8	0.12	513	6	6100	RL80E821MDNASQ□□	FP-2R5RE821M-L8□□-5K
		* 820	8×8	0.12	513	6	6100	RL80E821MCNASQ□□	FP-2R5RE821M-L8□□-5KH
		1000	8×8	0.12	625	6	6100	RL80E102MDN1□□	FP-2R5RE102M-L8□□
		1000	8×8	0.12	625	6	6100	RL80E102MCN1□□	FP-2R5RE102M-L8□□-H
		* 1000	8×8	0.12	625	6	6100	RL80E102MDNASQ□□	FP-2R5RE102M-L8□□-5K
		* 1000	8×8	0.12	625	6	6100	RL80E102MCNASQ□□	FP-2R5RE102M-L8□□-5KH
		1200	8×8	0.12	750	7	6100	RL80E122MDN1□□	FP-2R5RE122M-L8□□
		1200	8×8	0.12	750	7	6100	RL80E122MCN1□□	FP-2R5RE122M-L8□□-H
		* 1200	8×8	0.12	750	7	6100	RL80E122MDNASQ□□	FP-2R5RE122M-L8□□-5K
		* 1200	8×8	0.12	750	7	6100	RL80E122MCNASQ□□	FP-2R5RE122M-L8□□-5KH
		1500	8×8	0.12	938	7	6100	RL80E152MDN1□□	FP-2R5RE152M-L8□□
		1500	8×8	0.12	938	7	6100	RL80E152MCN1□□	FP-2R5RE152M-L8□□-H
* 1500	8×8	0.12	938	7	6100	RL80E152MDNASQ□□	FP-2R5RE152M-L8□□-5K		
* 1500	8×8	0.12	938	7	6100	RL80E152MCNASQ□□	FP-2R5RE152M-L8□□-5KH		
4.0 (0G)	4.6	560	8×8	0.12	560	6	6100	RL80G561MDN1□□	FP-4R0RE561M-L8□□
		560	8×8	0.12	560	6	6100	RL80G561MCN1□□	FP-4R0RE561M-L8□□-H
		* 560	8×8	0.12	560	6	6100	RL80G561MDNASQ□□	FP-4R0RE561M-L8□□-5K
		* 560	8×8	0.12	560	6	6100	RL80G561MCNASQ□□	FP-4R0RE561M-L8□□-5KH
		820	8×8	0.12	820	6	6100	RL80G821MDN1□□	FP-4R0RE821M-L8□□
		820	8×8	0.12	820	6	6100	RL80G821MCN1□□	FP-4R0RE821M-L8□□-H
		* 820	8×8	0.12	820	6	6100	RL80G821MDNASQ□□	FP-4R0RE821M-L8□□-5K
		* 820	8×8	0.12	820	6	6100	RL80G821MCNASQ□□	FP-4R0RE821M-L8□□-5KH
6.3 (0J)	7.2	470	8×8	0.12	592	8	5700	RL80J471MDN1□□	FP-6R3RE471M-L8□□
		470	8×8	0.12	592	8	5700	RL80J471MCN1□□	FP-6R3RE471M-L8□□-H
		* 470	8×8	0.12	592	8	5700	RL80J471MDNASQ□□	FP-6R3RE471M-L8□□-5K
		* 470	8×8	0.12	592	8	5700	RL80J471MCNASQ□□	FP-6R3RE471M-L8□□-5KH
		560	8×8	0.12	706	8	5700	RL80J561MDN1□□	FP-6R3RE561M-L8□□
		560	8×8	0.12	706	8	5700	RL80J561MCN1□□	FP-6R3RE561M-L8□□-H
		* 560	8×8	0.12	706	8	5700	RL80J561MDNASQ□□	FP-6R3RE561M-L8□□-5K
		* 560	8×8	0.12	706	8	5700	RL80J561MCNASQ□□	FP-6R3RE561M-L8□□-5KH
		680	8×8	0.12	857	8	5700	RL80J681MDN1□□	FP-6R3RE681M-L8□□
		680	8×8	0.12	857	8	5700	RL80J681MCN1□□	FP-6R3RE681M-L8□□-H
		* 680	8×8	0.12	857	8	5700	RL80J681MDNASQ□□	FP-6R3RE681M-L8□□-5K
		* 680	8×8	0.12	857	8	5700	RL80J681MCNASQ□□	FP-6R3RE681M-L8□□-5KH
		820	8×8	0.12	1033	8	5700	RL80J821MDN1□□	FP-6R3RE821M-L8□□
		820	8×8	0.12	1033	8	5700	RL80J821MCN1□□	FP-6R3RE821M-L8□□-H
		* 820	8×8	0.12	1033	8	5700	RL80J821MDNASQ□□	FP-6R3RE821M-L8□□-5K
		* 820	8×8	0.12	1033	8	5700	RL80J821MCNASQ□□	FP-6R3RE821M-L8□□-5KH
		1000	8×8	0.12	1260	9	5700	RL80J102MDN1□□	FP-6R3RE102M-L8□□
		1000	8×8	0.12	1260	9	5700	RL80J102MCN1□□	FP-6R3RE102M-L8□□-H
* 1000	8×8	0.12	1260	9	5700	RL80J102MDNASQ□□	FP-6R3RE102M-L8□□-5K		
* 1000	8×8	0.12	1260	9	5700	RL80J102MCNASQ□□	FP-6R3RE102M-L8□□-5KH		

# RL8

## ■ Dimensions

Rated Voltage (V) (code)	Surge Voltage (V)	Rated Capacitance (μF)	Case Size φD×L (mm)	tan δ	Leakage Current (μA) (at 20°C after 2 minutes)	ESR (mΩ) (20°C/100kHz)	Rated Ripple Current (mA rms) (105°C/100kHz)	NICHICON	FPCAP
16 (1C)	18.4	100	8×8	0.12	320	12	5000	RL81C101MDN1□□	FP-016RE101M-L8□□
		100	8×8	0.12	320	12	5000	RL81C101MCN1□□	FP-016RE101M-L8□□-H
		*100	8×8	0.12	320	12	5000	RL81C101MDNASQ□□	FP-016RE101M-L8□□-5K
		*100	8×8	0.12	320	12	5000	RL81C101MCNASQ□□	FP-016RE101M-L8□□-5KH
		180	8×8	0.12	576	12	5000	RL81C181MDN1□□	FP-016RE181M-L8□□
		180	8×8	0.12	576	12	5000	RL81C181MCN1□□	FP-016RE181M-L8□□-H
		*180	8×8	0.12	576	12	5000	RL81C181MDNASQ□□	FP-016RE181M-L8□□-5K
		*180	8×8	0.12	576	12	5000	RL81C181MCNASQ□□	FP-016RE181M-L8□□-5KH
		220	8×8	0.12	704	12	5000	RL81C221MDN1□□	FP-016RE221M-L8□□
		220	8×8	0.12	704	12	5000	RL81C221MCN1□□	FP-016RE221M-L8□□-H
		*220	8×8	0.12	704	12	5000	RL81C221MDNASQ□□	FP-016RE221M-L8□□-5K
		*220	8×8	0.12	704	12	5000	RL81C221MCNASQ□□	FP-016RE221M-L8□□-5KH
		270	8×8	0.12	864	10	5000	RL81C271MDN1□□	FP-016RE271M-L8□□
		270	8×8	0.12	864	10	5000	RL81C271MCN1□□	FP-016RE271M-L8□□-H
		*270	8×8	0.12	864	10	5000	RL81C271MDNASQ□□	FP-016RE271M-L8□□-5K
		*270	8×8	0.12	864	10	5000	RL81C271MCNASQ□□	FP-016RE271M-L8□□-5KH
		330	8×8	0.12	1056	12	5000	RL81C331MDN1□□	FP-016RE331M-L8□□
		330	8×8	0.12	1056	12	5000	RL81C331MCN1□□	FP-016RE331M-L8□□-H
		*330	8×8	0.12	1056	12	5000	RL81C331MDNASQ□□	FP-016RE331M-L8□□-5K
		*330	8×8	0.12	1056	12	5000	RL81C331MCNASQ□□	FP-016RE331M-L8□□-5KH
470	8×8	0.12	1504	16	4000	RL81C471MDN1□□	FP-016RE471M-L8□□		
470	8×8	0.12	1504	16	4000	RL81C471MCN1□□	FP-016RE471M-L8□□-H		
20 (1D)	23.0	*330	8×8	0.12	1320	17	3880	RL81D331MCNASQ□□	FP-020RE331M-L8□□-5KH
35 (1V)	40.2	100	8×8	0.12	700	25	3000	RL81V101MDN1□□	FP-035RE101M-L8□□
		100	8×8	0.12	700	25	3000	RL81V101MCN1□□	FP-035RE101M-L8□□-H

\* : Load life 5000hours.

## ■ Frequency Characteristics (The frequency characteristics are typical and not a guaranteed value.)

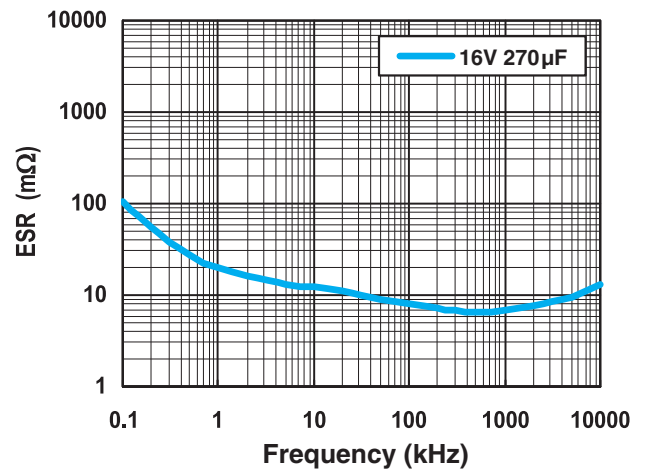
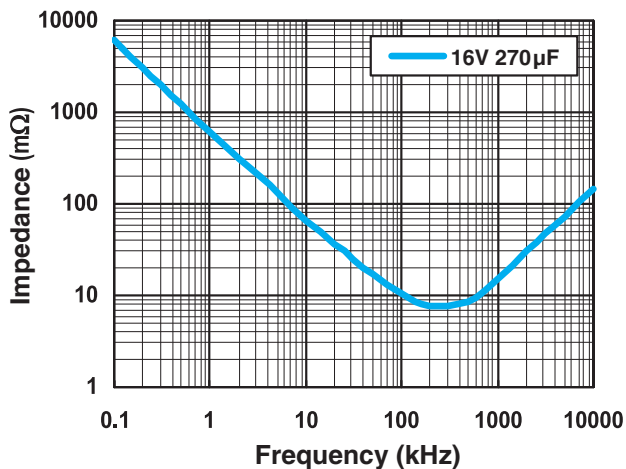

• For formed lead or taped product specifications and minimum order quantity, please refer to the Guidelines for Aluminum Electrolytic Capacitors.

## X-ON Electronics

Largest Supplier of Electrical and Electronic Components

*Click to view similar products for [Aluminium Organic Polymer Capacitors](#) category:*

*Click to view products by [Nichicon](#) manufacturer:*

Other Similar products are found below :

[750-1809](#) [SEAU0A0102G](#) [MAL218497801E3](#) [MAL218297003E3](#) [MAL218497803E3](#) [MAL218397603E3](#) [MAL218297802E3](#)

[MAL218497701E3](#) [MAL218397102E3](#) [MAL218297804E3](#) [MAL218497804E3](#) [MAL218697005E3](#) [MAL218697509E3](#) [MAL218297603E3](#)

[MAL218397604E3](#) [MAL218697106E3](#) [MAL218297005E3](#) [MAL218397106E3](#) [MAL218297103E3](#) [MAL218397104E3](#) [MAL218297604E3](#)

[MAL218697601E3](#) [MAL218697554E3](#) [MAL218697607E3](#) [MAL218397702E3](#) [MAL218497901E3](#) [MAL218497806E3](#) [MAL218697001E3](#)

[PCZ1V181MCL1GS](#) [PCZ1E331MCL1GS](#) [35PZF270MT810X9](#) [HHXD500ARA470MHA0G](#) [APD1012271M035R](#) [APD1012331M035R](#)

[APA0609471M006R](#) [APA0609561M004R](#) [APA0609561M006R](#) [APD0811271M035R](#) [APA0807561M004R](#) [APA0809331M016R](#)

[APA0809561M010R](#) [APA0809821M004R](#) [APA0809821M006R](#) [APA0812471M016R](#) [APA0812561M016R](#) [APA1010122M006R](#)

[APA1012122M010R](#) [APA1012821M016R](#) [SPT1EM101D11OR](#) [SPT0JM101D08ORVZC](#)