

RoHS compliant

## FEATURES

- RoHS compliant
- Optimum for high density board mounting applications
- Compatible with most automatic pick & place machinery (J-hook and Gull wing types only)
- Compatible with reflow and wave soldering
- Protection against dust and washable after soldering
- Excellent reliability due to precious metal contact
- Resin materials are UL Recognized 94V-0 or 94V-1 equivalent

## INTERNAL STRUCTURE

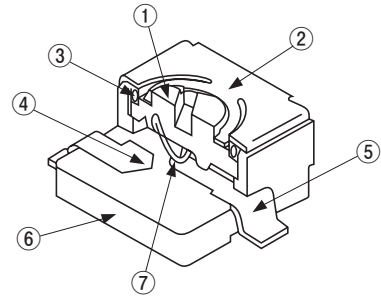

Part name	Material
① Rotor	Polyphenylenesulphide
② Cover	Stainless steel (SUS 304)
③ "O" ring	Silicone rubber
④ Fixed contact	Copper alloy, Gold-plated
⑤ Terminal pin	
⑥ Housing	Epoxy
	※ LCP (LC polymer)
⑦ Slider contact	Multi metal alloy

※ : 1 pole 4 contacts only

## PART NUMBER DESIGNATION

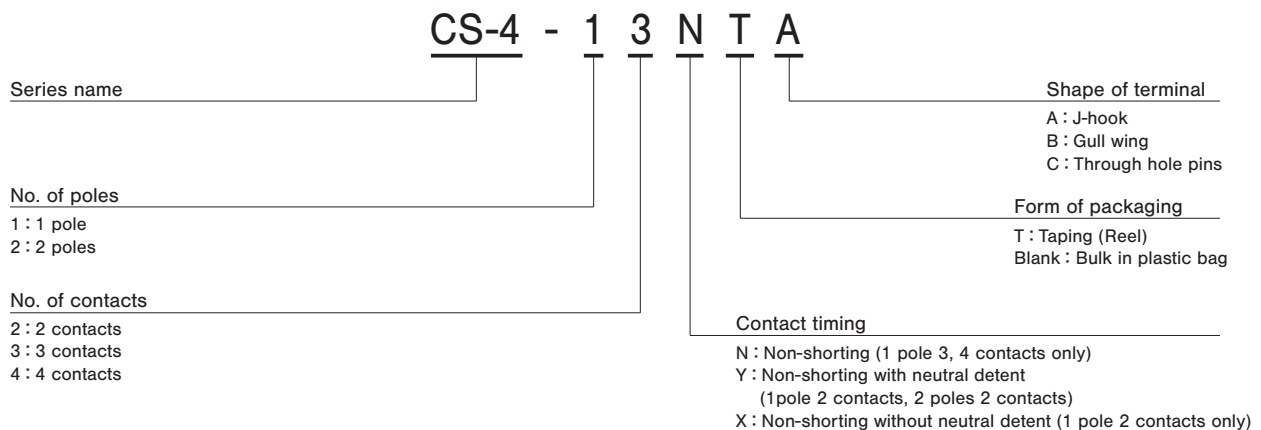

※ Please refer to the LIST OF PART NUMBERS when placing orders.

# CS-4

## ROTARY SELECTOR SWITCHES (SMD)

### SCHEMATICS DIAGRAMS

#### 1 pole 2 contacts

Series	Switching specifications	Schematic
CS-4-12YA // YTA // YB // YTB // YC		
CS-4-12XA // XTA // XB // XTB // XC		

#### 1 pole 4 contacts

Series	Switching specifications	Schematic
CS-4-14NA // NTA // NB // NTB		

#### 1 pole 3 contacts

Series	Switching specifications	Schematic
CS-4-13NA // NTA // NB // NTB		

#### 2 poles 2 contacts

Series	Switching specifications	Schematic
CS-4-22YA // YTA // YB // YTB		

### LIST OF PART NUMBERS

Circuit type		Form of packaging	A J-hook	B Gull wing	C Through hole pin	Pieces in package
1 pole 2 contacts	With neutral detent	Taping	CS-4-12YTA	CS-4-12YTB	CS-4-12YC	500 pcs./reel
		Plastic bag	CS-4-12YA	CS-4-12YB		50 pcs./pack
	Without neutral detent	Taping	CS-4-12XTA	CS-4-12XTB	CS-4-12XC	500 pcs./reel
		Plastic bag	CS-4-12XA	CS-4-12XB		50 pcs./pack
1 pole 3 contacts		Taping	CS-4-13NTA	CS-4-13NTB		500 pcs./reel
		Plastic bag	CS-4-13NA	CS-4-13NB		50 pcs./pack
1 pole 4 contacts		Taping	CS-4-14NTA	CS-4-14NTB		500 pcs./reel
		Plastic bag	CS-4-14NA	CS-4-14NB		50 pcs./pack
2 poles 2 contacts		Taping	CS-4-22YTA	CS-4-22YTB		500 pcs./reel
		Plastic bag	CS-4-22YA	CS-4-22YB		50 pcs./pack

☐: Not manufactured

※ Verify the above part numbers when placing orders.  
Taping version can be supplied only in reel unit.

# CS-4

## ROTARY SELECTOR SWITCHES (SMD)

### STANDARD SPECIFICATIONS

Circuit type	1 pole 2 contacts 2 poles 2 contacts 1 pole 3 contacts 1 pole 4 contacts
Operating temperature range	- 25 ~ 70 °C
Storage temperature range	- 40 ~ 70 °C
Sealing	Washable by "O" ring ※ Please refer to page 150, 151
Net weight	Approx. 0.08 g (CS-4-12, CS-4-13) Approx. 0.1 g (CS-4-14, CS-4-22)

### MECHANICAL CHARACTERISTICS

No. of positions	2, 3, 4
Adjustment torque	10 mN·m {102 gf·cm} maximum
Stopper strength	25 mN·m {255 gf·cm} minimum
Stepping angle	45° 90° (CS-4-12X only)
Solderability	245 ± 3 °C, 2 ~ 3 s
Soldering heat	Flow : 260 ± 3 °C as the temperature in a pot of molten solder, immersion from head of terminal to backside of board, 5 ~ 6 s, two times maximum Reflow : Peak temperature 255 °C (Please refer to the profile below.) Manual soldering : 350 ± 10 °C, 3 ~ 4 s
Shear (Adhesion)	5 N {0.51 kgf}, 10 s
Substrate bending	Width 90 mm, bend 3 mm, 5 s, 1 time
Pull-off strength	5 N {0.51 kgf}, 10 s

{ } : Reference only

### ELECTRICAL CHARACTERISTICS

Contact rating	0.5 VA
Maximum current	100 mA
Minimum current	1 μA
Maximum voltage	16 V
Minimum voltage	20 mV
Contact timing	Non-shorting
Contact resistance	100 mΩ maximum
Insulation resistance	100 MΩ (DC500 V) minimum
Dielectric strength	AC500 V, 60 s

### ENVIRONMENTAL CHARACTERISTICS

Vibration	(Amplitude) 1.5 mm (or (Acceleration) 98 m/s <sup>2</sup> , 10-500-10 Hz, 3 directions for 2 h each
Shock	490 m/s <sup>2</sup> , 11 ms 6 directions for 3 times each
Load life	200 cycles minimum DC16 V, 30 mA
Humidity (Steady state)	40 °C, Relative humidity 90 ~ 95 %, 48 h
High temperature exposure	70 °C, 16 h
Low temperature exposure	- 40 °C, 16 h
Thermal shock	- 40 (0.5 h) ~ 70 °C (0.5 h), 5 cycles

#### 〈Reflow profile for soldering heat evaluation〉

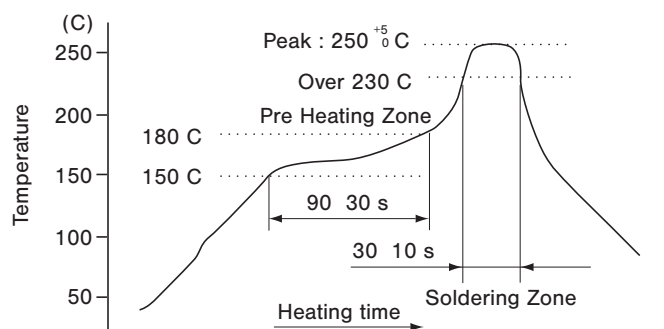

Reflow : two times maximum

# CS-4

## ROTARY SELECTOR SWITCHES (SMD)

### OUTLINE DIMENSIONS

Unless otherwise specified, tolerance:  $\pm 0.3$  (Unit: mm)

#### CS-4-12YA

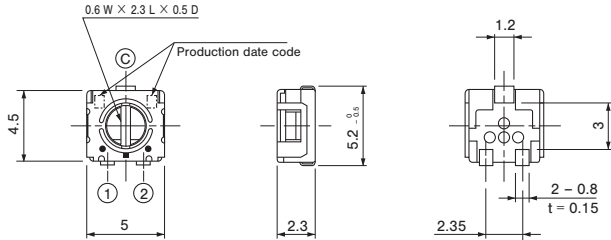

#### CS-4-12YB

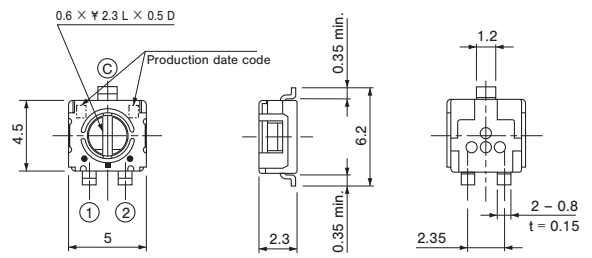

#### CS-4-12YC

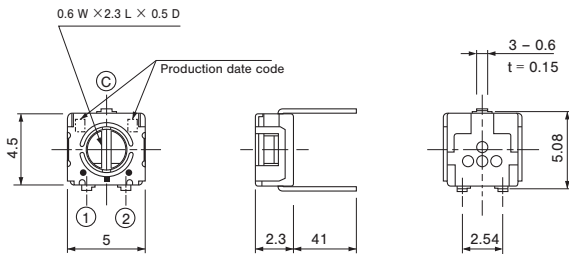

#### CS-4-12XA

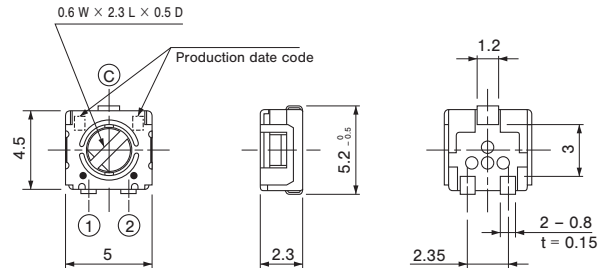

#### CS-4-12XB

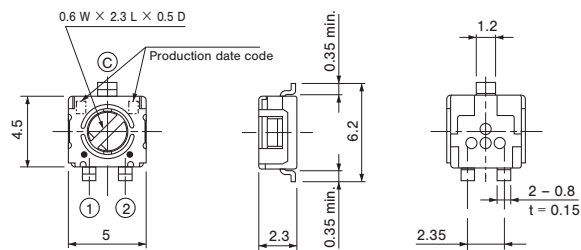

#### CS-4-12XC

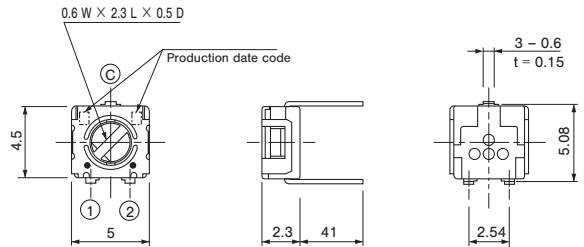

#### CS-4-13NA

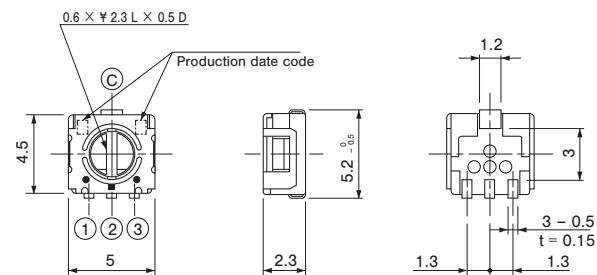

#### CS-4-13NB

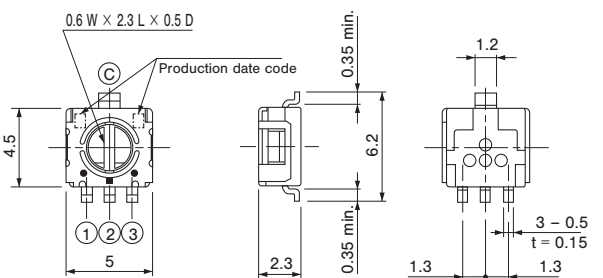

#### CS-4-14NA

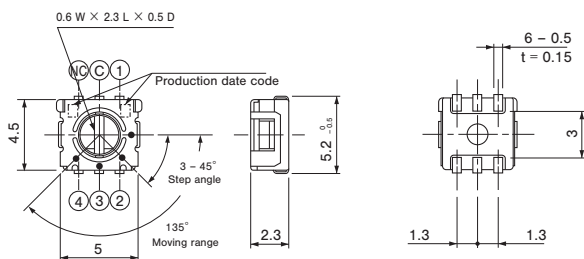

#### CS-4-14NB

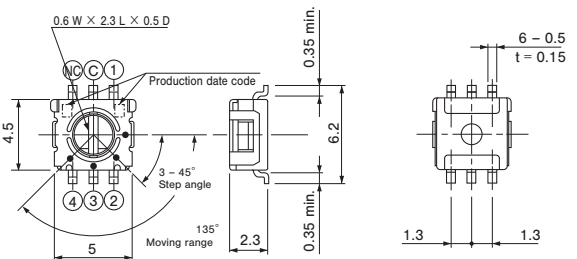

### OUTLINE DIMENSIONS

#### CS-4-22YA

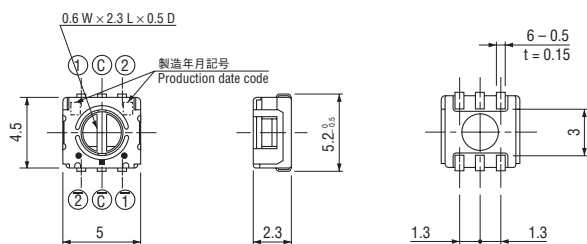

Unless otherwise specified, tolerance:  $\pm 0.3$  (Unit: mm)

#### CS-4-22YB

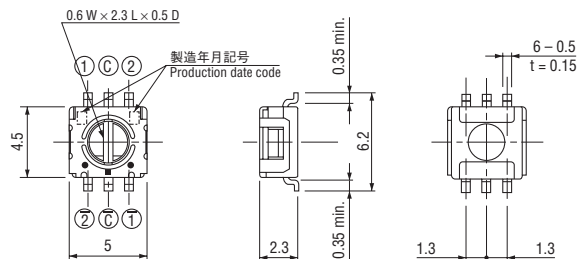

### RECOMMENDED P.C.B. PAD OUTLINE DIMENSIONS

#### CS-4-12YA

#### CS-4-12XA

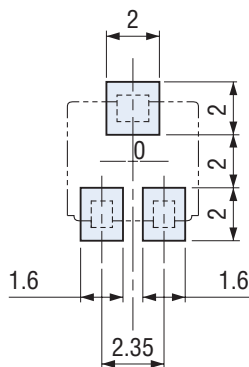

#### CS-4-12YB

#### CS-4-12XB

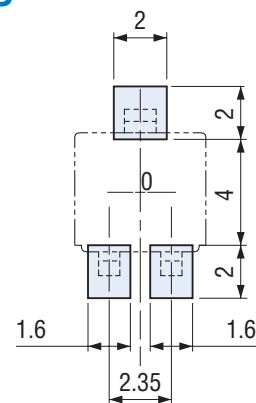

(Unit: mm)

#### CS-4-13NA

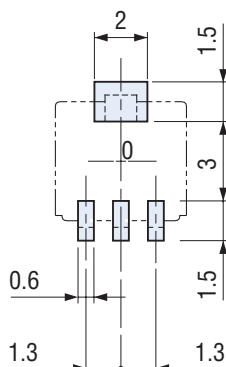

#### CS-4-13NB

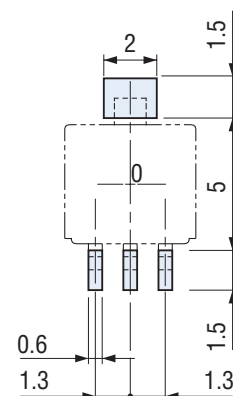

#### CS-4-14NA

#### CS-4-22YA

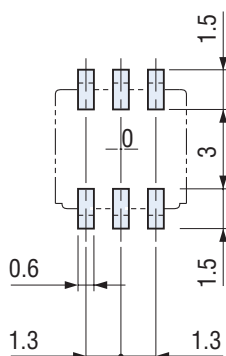

#### CS-4-14NB

#### CS-4-22YB

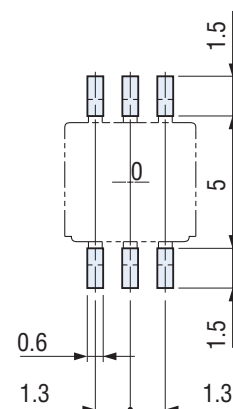

Note) The zero point is the center of mounting.

# CS-4

## ROTARY SELECTOR SWITCHES (SMD)

### SOLDERING CONDITIONS

When dip-soldering CS-4-13NA, NB or CS-4-22YA, YB, solder bridges may occur between terminals depending upon soldering conditions.

In order to prevent such bridges, vertical flow direction is recommended as shown in the below figure.

For dip-soldering, preheating should be done after applying flux.

Handle carefully in case of parallel flow direction in which solder bridges occur more often because solder flow moves toward the vertical direction against the terminals.

In addition, other soldering conditions such as soldering temperature, preheating temperature, specific gravity of flux, and belt speed affect the occurrence of bridges.

Depending on flux to be applied, markings may, though at rare case, disappear or fade out at soldering. Please make sure before its use.

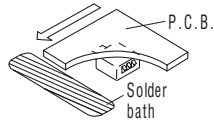
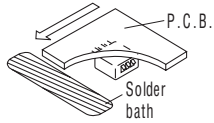
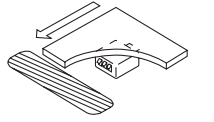
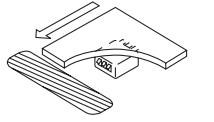
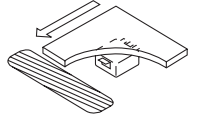
Flow direction	CS-4-13NA, NB	CS-4-22YA, YB
Vertical		
Parallel		
		

### PACKAGING SPECIFICATIONS

#### <Taping packaging specifications>

- Taping version is packaged in 500 pcs. per reel.  
Orders will be accepted for units of 500 pcs., i.e., 500, 1000, 1500 pcs., etc.
- Taping version is boxed with 4 reels (2000 pcs.).

Maximum number of consecutive missing pieces=2

Leader length and reel dimension are shown in the dia-grams below:

#### ● Embossed tape dimensions

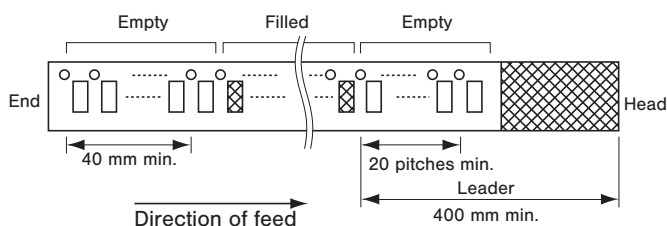

#### ● Reel dimensions

(Unit: mm)

(Conforms to JIS C 0806-3)

(In accordance with EIAJ ET-7200A)

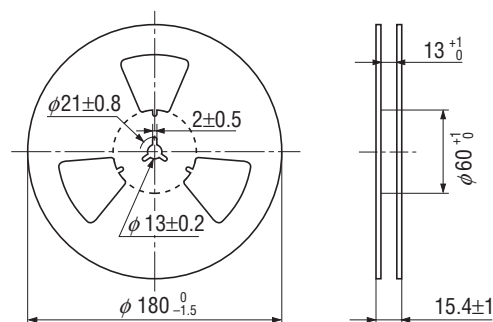

#### ● CS-4-□□□ TA/CS-4-□□□ TB

(Conforms to JIS C 0806)

(Unit: mm)

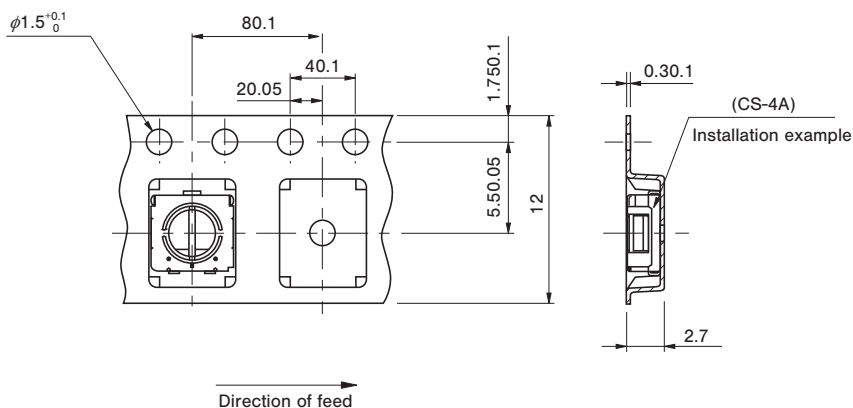

#### <Bulk pack specifications>

- The smallest unit of bulk pack in a plastic bag is 10 pcs. per pack. Orders will be accepted for unit of minimum 10 pcs., i.e., 10, 20, 30 pcs., etc.
- Boxing of bulk in a plastic bag is performed with 50 pcs. (standard 500 pcs.) per box.

## X-ON Electronics

Largest Supplier of Electrical and Electronic Components

*Click to view similar products for [Coded Rotary Switches](#) category:*

*Click to view products by [Nidec Copal](#) manufacturer:*

Other Similar products are found below :

[PT65503RT](#) [Y36D02243FPLFT](#) [RTAP31S12WFLSP](#) [MADR-16H1](#) [GSER-10](#) [6KF001B-3S10R4-0](#) [EC11E153442W](#) [EC11E1534441](#) [SC-2110](#) [SD-2010TB](#) [MER-16H](#) [EDR-08](#) [USR-10](#) [FSR-08](#) [FSR-04S](#) [ESR-16](#) [HAMR-10S](#) [SDR-10H](#) [QSR-16H](#) [HAMR-16](#) [FDR-04S](#) [EDR-16S](#) [ESR-10S](#) [QDR-08H1](#) [EDR-08S](#) [ESR-16H](#) [QDR-10](#) [EDR-10S](#) [QSR-06S](#) [ESR-08S](#) [EC11E156040N](#) [EC11B15243DC](#) [EC35AH220501](#) [EC18AGB20406](#) [EC11E09244C3](#) [EC11G1534414](#) [EC11E156T402](#) [EC11E1564454](#) [EC11E15204B1](#) [EC11E1564439](#) [EC50A0920403](#) [ED103180-FE14.5S7.5-A16-1010](#) [ED08E42S-FE15C7.0-A16-1020](#) [ED08C030-FE18C9.0-A16-1002X](#) [ED08C210-FE18A6.0-A16-1002](#) [ED08C150-BM20S6.0-A16-1026](#) [ED103010-SP17S8.0-A16-1012](#) [ED113020-FB15S7.0-C12-0005](#) [ED121220-FB20B7.0-C24-0001-G219](#) [ED231010-FB35A10-A40-1001](#)