

PRESSURE SWITCHES

PS20

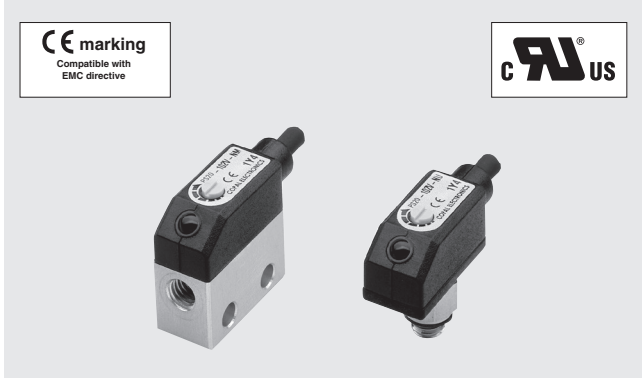

FEATURES

- Ultra-small size pressure transducer with Amp.
- With 1 switch output
- 2 types of pressure ports are available
- Meet EMC standards

INTERNAL STRUCTURE
(2-M5 female screw)

Part name	Material
① Pressure port	Aluminum
② Housing	PC (Polycarbonate)
③ Sensor module	PPS (Polyphenylenesulphide)
④ "O" ring	Fluoro-rubber
⑤ Cable	Vinyl chloride resin
⑥ VR	POM (polyoxymethylene)

MODEL NUMBER DESIGNATION

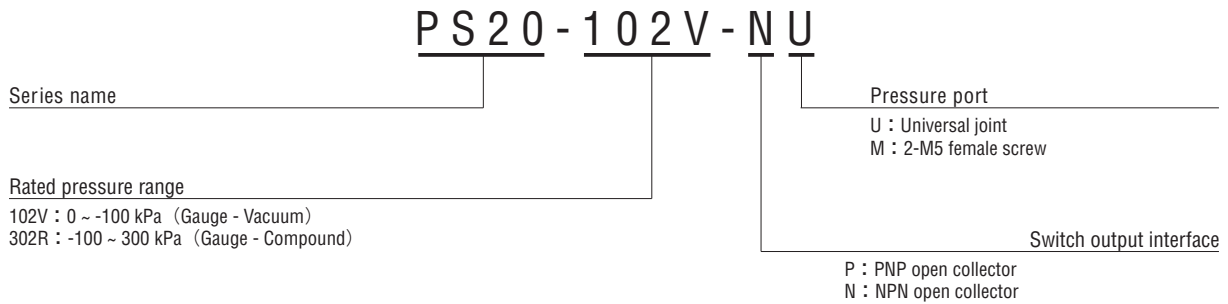

LIST OF MODEL NUMBERS

Pressure port	Pressure reference	Rated pressure range [kPa]	
		0 ~ - 100	- 100 ~ 300
Universal joint	NPN	PS20-102V-NU	PS20-302R-NU
	PNP	PS20-102V-PU	PS20-302R-PU
2-M5 female screw	NPN	PS20-102V-NM	PS20-302R-NM
	PNP	PS20-102V-PM	PS20-302R-PM

※ Verify the above model numbers when placing orders.

STANDARD SPECIFICATIONS

● Unless otherwise specified, the specs are defined at an ambient temperature of 25±5 °C and excitation voltage of 24 V DC.

Item	Model number	PS20	
		102V	302R
General specifications	Pressure reference	Gauge	
	Rated pressure range	0 ~ – 100	– 100 ~ 300
	Maximum pressure	200	600
	Operating temp. range	– 10 ~ 60	
	Compensated temp. range	0 ~ 50	
	Operating humidity	35 ~ 85	
	Storage temp.	– 20 ~ 70	
	Pressure medium	Non-corrosive gases	
	Insulation resistance	100	
	Dielectric strength	500 V AC, 60 s	
	Net weight (Without cable)	Approx. 4 (PS20- * * * * - * U) 7 (PS20- * * * * - * M)	
Power	Supply voltage	10.8 ~ 30 (Including ripple percentage)	
	Consumption current	20 mA	
Switch output	No. of output	1	
	Output interface	NPN/PNP open collector output	
	Setting method	Adjustable by VR	
	Adjustable range	Zero through rated pressure, minimum	
	Display	Red LED (lighted when output is ON.)	
	Accuracy 0 ~ 50 °C (Reference temp.: 25 °C)	± 3	
	Hysteresis	2	
	Switching capacity	30 V DC 80 mA maximum	
	Residual voltage	0.8 (NPN), 1.8 (PNP)	
	Response	Approx. 1	

ENVIRONMENTAL CHARACTERISTICS

Test item	Test conditions	Permissible change
Vibration	10 ~ 55 Hz, 1.5 mm maximum, 3 directions for 2 hours each	Switch output pressure : ± 2 %F.S., maximum after test
Shock	1000 m/s ² , 3 directions for 3 times each	
Pressure cycling	0 ~ Rated pressure, 10 ⁶ cycles	
Moisture resistance	40 °C, 90 ~ 95 %RH, 240 hrs.	
EMC	EMI : EN55011: 2007, A2 : 2007 Group 1, class B EMS : EN61326-1 : 2006 Table 2	Switch operating pressure : ± 5 %F.S., maximum during tset

PS20

PRESSURE SWITCHES

OUTLINE DIMENSIONS

Unless otherwise specified, tolerance : ± 0.5 (Unit: mm)

Universal joint type

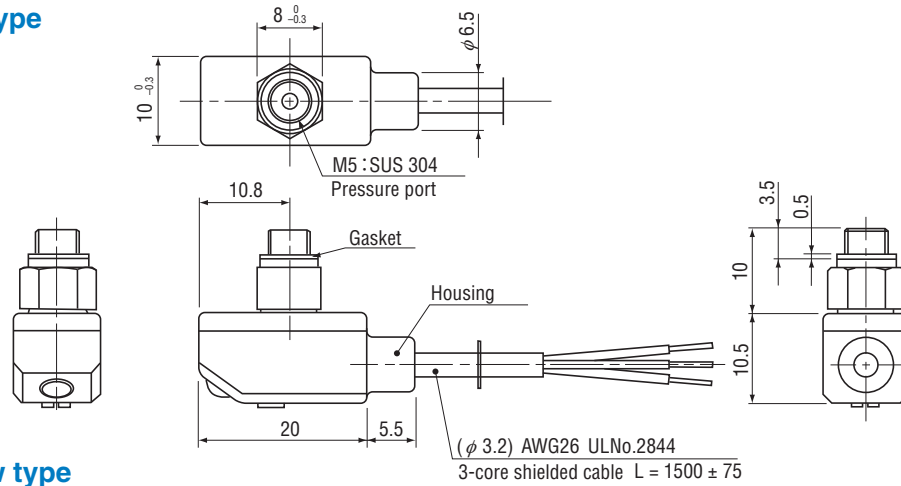

M5 female screw type

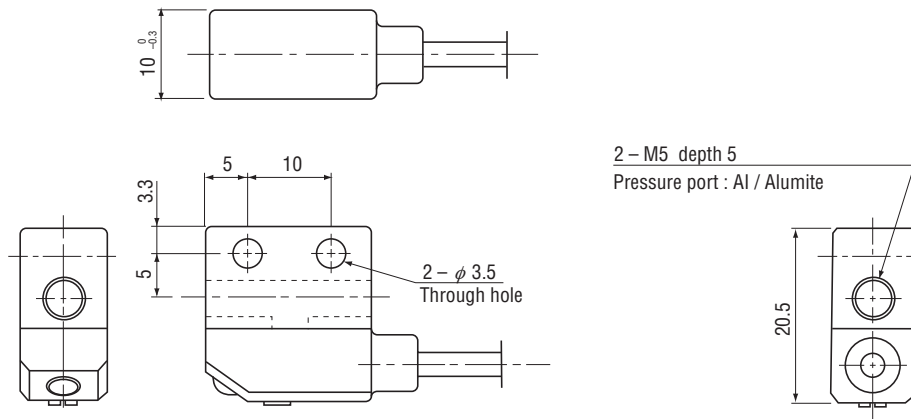

PS20

Wire color	Connection
Brown	Power ⊕
Black	Switch output
Blue	Common

INTERNAL ELECTRICAL SCHEMATICS

NPN open collector

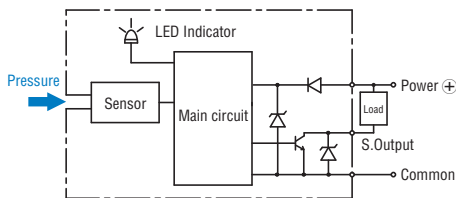

PNP open collector

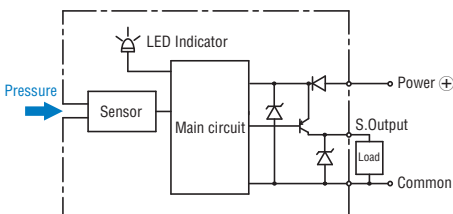

SWITCH OUTPUT SCHEMATICS

Turns on at the set pressure and turns off at the set pressure minus the hysteresis.

102V

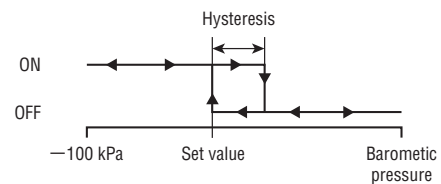

302R

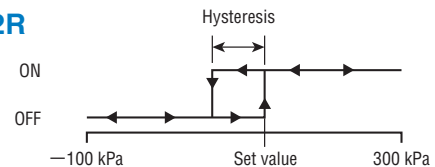

X-ON Electronics

Largest Supplier of Electrical and Electronic Components

Click to view similar products for [Industrial Pressure Sensors](#) category:

Click to view products by [Nidec Copal](#) manufacturer:

Other Similar products are found below :

[75380-05](#) [76053-00000300-01](#) [76053-00000300-05](#) [76061-00000015-01](#) [76062-B00000350-01](#) [76063-00000350-05](#) [76083-05000500-01](#)
[76311-05](#) [76577-00000070-01](#) [76584-M00000100-24](#) [77343-24.0H2-01](#) [77343-25.0H2-01](#) [78291-B00000060-01](#) [78303-B00000400-01](#)
[78303-B00000400-05](#) [78316-B00000030-01](#) [78353-B00000020-05](#) [78665-00000014-05](#) [78677-B00000070-05](#) [78678-00000040-01](#) [79279-](#)
[00000060-01](#) [79296-B00000350-01](#) [79322-00250035-01](#) [79614-30.0H2-14](#) [79670-00000090-15](#) [79700-00002750-01](#) [79917-B00000280-01](#)
[80569-00700100-01](#) [81509081](#) [81739-B00000900-01](#) [81807-B00000020-01](#) [MLH010BST01A](#) [MLH010BST14A](#) [MLH025BGC13B](#)
[MLH025BSCDJ1292](#) [MLH025BSCDJ1303](#) [MLH750PSCDJ1245](#) [82903-B00000020-01](#) [83250-02500600-05](#) [83271-00000040-04](#) [83278-](#)
[B00000200-21](#) [83286-00000150-01](#) [83299-00000150-05](#) [83303-00000600-01](#) [83305-00001350-01](#) [83330-00000100-01](#) [83349-00001470-24](#)
[83350-04.0HG-05](#) [83350-15.0H2-05](#) [83357-00000030-21](#)