

REV.	DESCRIPTION	DRAWN	CHECKED	APPROVED
A	NEW RELEASE	LJH 04/27/05'		LJH 04/22/06'
B	ADD SCREW TYPE	DMJ 06/27/07'		LJC 06/27/07'
C	露理図面	YCH 05/21/08'		LJC 05/21/08'
F	ADD Pos TYPE	JLZ 03/29/16'		

NOTES:  
 1. ELECTRICAL CHARACTERISTICS:  
 1.1 CONTACT RESISTANCE: 20mΩ Max. INITIAL.  
 1.2 DIELECTRIC WITHSTANDING VOLTAGE: 500V AC(rms) FOR 1 MINUTE.  
 1.3 INSULATION RESISTANCE: 1000MΩ Min.  
 2. ENVIRONMENT CHARACTERISTICS:  
 TEMPERATURE RANGE: -40℃~+105℃.  
 3. PART NUMBER: DS1034  
 4. PRODUCT NUMBER CODE: DS1034-X X X X X X X X X X X X X X X X

- SCREW DIM. A  
 S: Standard(W/O nut)  
 1: 5.00 2: 3.00 3: 5.20  
 4: 4.80 5: 5.80 6: 4.00  
 7: 4.80mm(inside thread M2.6\*0.45p, outside thread unc#4-40)  
 8: 4.80mm(inside thread M3.0\*0.5p, outside thread unc#4-40)
- SCREW TYPE  
 S: Standard(W/O nut)  
 1: CC TYPE 2: CS TYPE  
 3: BR TYPE 4: BRJ TYPE DIM. B:6.00 C: 3~4mm  
 5: BRJ TYPE DIM. B:6.00 C: 5~6mm  
 6: BRJ TYPE DIM. B:6.00 C: 3~4mm  
 (inside thread M2.6\*0.45p, outside thread unc#4-40)  
 7: BRJ TYPE DIM. B:6.00 C: 3~4mm  
 (inside thread M3.0\*0.50p, outside thread unc#4-40)
- CONTACT PLATING  
 Si: FULL GOLD FLASH  
 O: SELECTIVE GOLD FLASH
- SHELL PLATING  
 T: FRONT & BACK SHELL TIN  
 N: FRONT SHELL,NICKEL,BACK SHELL TIN
- HOUSING COLOR  
 B: BLACK W: WHITE  
 U: BLUE
- CONNECTOR TYPE  
 M: MALE F: FEMALE
- No. OF CONTACTS  
 09: 9pos. 15: 15pos. 25: 25pos.  
 37: 37pos. 50: 50pos.

PROJECTION

UNITS mm

SHEET SIZE A4

SERIES DS1034 SERIES

D-SUB DIP STRAIGHT TYPE

PROJECTION

ANGLE TOLERANCE

GENERAL TOLERANCE

X. ±0.60 X. ±0.38 X. ±0.25

X. ±5. X. ±3. XX ±2.

DRAWING TYPE CUSTOMER

SCALE 1:1

SHEET 1 OF 1

C-DS1034-XXXXXX-F

CONNFLY CONNFLY ELECTRONIC CO., LTD

晨翔电子有限公司

DRAWING NO.	C-DS1034-XXXXXX-F	
SCALE	1:1	SHEET 1 OF 1
DRAWING TYPE	CUSTOMER	
GENERAL TOLERANCE	X. ±0.60 X. ±0.38 X. ±0.25	X. ±5. X. ±3. XX ±2.

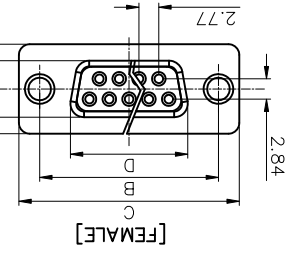
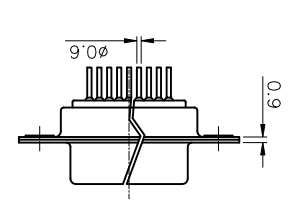
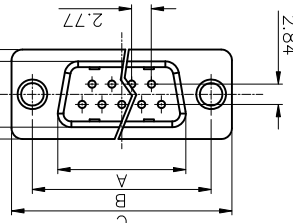
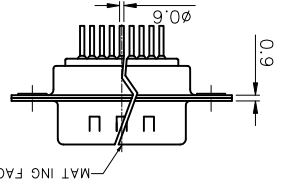
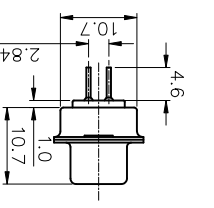
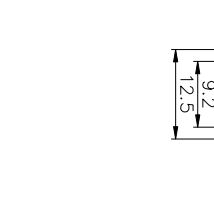
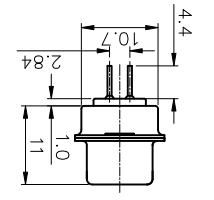
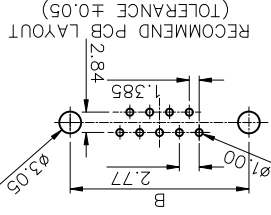
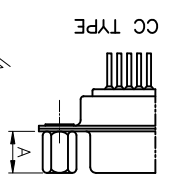
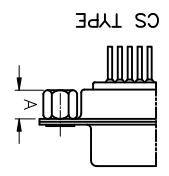
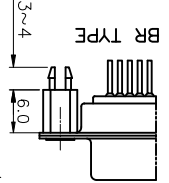
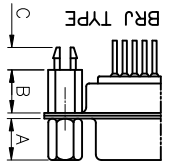
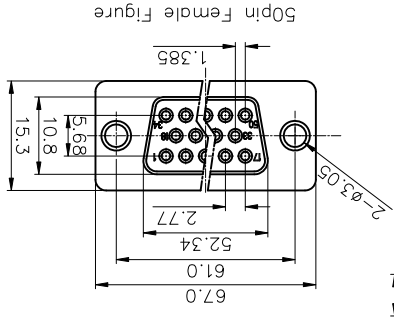
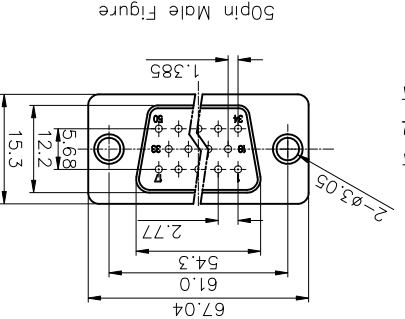
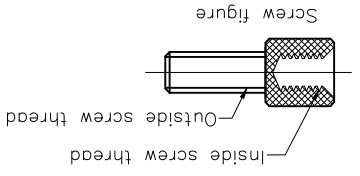

Dimension

A±0.2	B±0.2	C±0.3	D
9	17.90	24.99	30.80
15	26.50	33.32	39.14
25	40.00	47.04	53.04
37	56.50	63.50	69.32
			54.84

Position

## X-ON Electronics

Largest Supplier of Electrical and Electronic Components

*Click to view similar products for [D-Sub Standard Connectors](#) category:*

*Click to view products by [Connfly](#) manufacturer:*

Other Similar products are found below :

[DCM37S732N](#) [DAM15P500](#) [DEV09S364GTLF](#) [DEM09P032N](#) [DDM50P732N](#) [DAM15S332N](#) [173109-2218](#) [173109-2466](#) [173109-2436](#)  
[173109-2435](#) [56F706-005-LI](#) [56F711-015](#) [015-0341-000](#) [015-0372-008](#) [015-8544-011](#) [017041-0005](#) [020419-0104](#) [012-0515-000](#) [012-9507-](#)  
[034](#) [012-9507-114](#) [012-9534-001](#) [020745-0008](#) [609-25P](#) [M24308/2-23Z](#) [M243082310F](#) [M243082410F](#) [M243082411F](#) [M24308/4-21](#)  
[CT1A18-11PSA206](#) [CT1N36-5SC](#) [CT2-16S-17PS](#) [CT2-20-15PCAU](#) [CT2-24-12PS](#) [CT2-24-28PSF127A206](#) [CT2-32-9PC](#) [CT6F9767-14-4-](#)  
[14S-5PC](#) [CT6FA10SL-4PS](#) [CT7-18-10SC](#) [CT7-18-10SCAU](#) [CT7-18-12SCAU](#) [CT7-18-1PC](#) [CT7-18-1PCAU](#) [CT7-18-21SCAU](#) [M83513/01-](#)  
[FC](#) [M83723/76W24619 L/C](#) [M85049/48-3-2F](#) [69001-865](#) [6STD09PCM99B70X](#) [6STD09SCM99B30X](#) [6STD09SCT99S40X](#)