

Position	A±0.2	B±0.2	C±0.2	D
9	17.90	24.99	30.80	16.33
15	26.50	33.32	39.14	24.66
25	40.00	47.04	53.04	38.38
37	56.50	63.50	69.32	54.84

Dimension

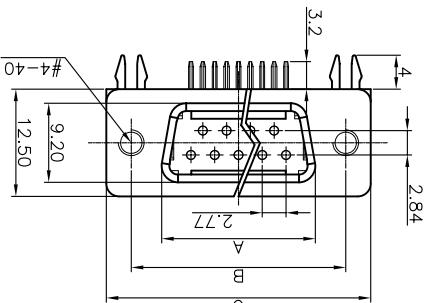

[MALE]

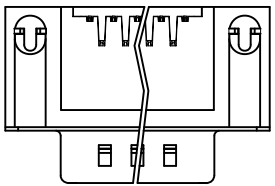
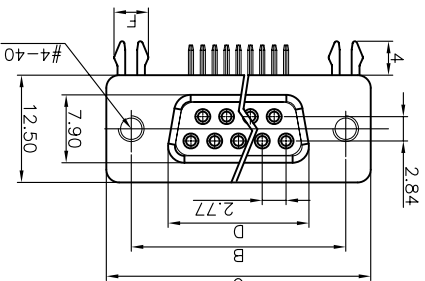
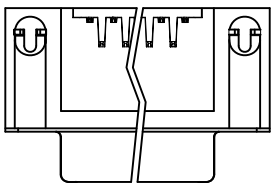

[FEMALE]

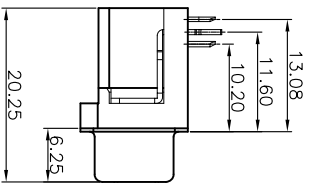
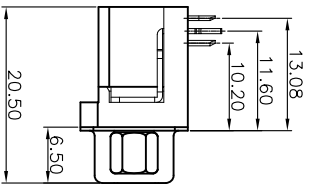

RECOMMEND PCB LAYOUT(TOLERANCE ±0.05)
(VIEW FROM TOP SIDE)

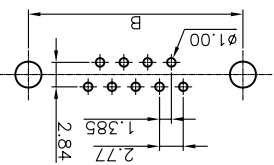

WITH SCREW AND RIVET TYPE

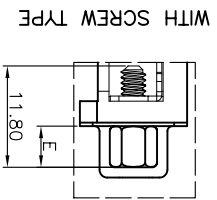
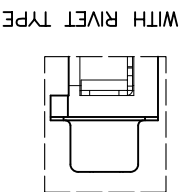
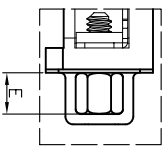

WITH SCREW TYPE

GENERAL TOLERANCE		ANGLE TOLERANCE	
X.	±0.50	X.	±3.
.X	±0.30	.X	±2.
.XX	±0.20	.XX	±1.
DRAWING TYPE ASSEMBLY		SHEET 1 OF 1	
SCALE 1:1		DRAWING NO. C-DS1037-01-XXXXXX-B	

PROJECTION	UNIT	SHEET SIZE	SERIES	TITLE
第一角	mm	A4	DS1037-01 SERIES	D-SUB RIGHT ANGLE(9.4mm) TYPE

晨翔电子有限公司 CONNPLY CONNPLY ELECTRONIC CO., LTD

8 7 6 5 4 3 2 1

REV.	DESCRIPTION	DRAWN	CHECKED	APPROVED
B	新增螺丝规格	YCH 11/05/11'		
A	NEW RELEASE	LJH 06/14/07'		
				LJC 06/14/07'

NOTES: 备注

1. PRODUCTS PERFORMANCE:

1.0 VOLTAGE RATING: 250V AC.

1.1 CONTACT CURRENT RATING: 1.5A MAX. PER PIN.

1.2 CONTACT RESISTANCE: 20mΩ MAX.

1.3 DIELECTRIC WITHSTANDING VOLTAGE: 500V AC(ms)

FOR 1 MINUTE.

1.4 INSULATION RESISTANCE: 1000MΩ MIN.

1.5 OPERATING TEMPERATURE: -40°C~+105°C.

2. PRODUCT NUMBER CODE:

DS1037 -01- X X X X X X X X

SCREW DIM. E

4: 4.80mm

5: 5.80mm

6: 4.80mm(inside thread M2.6*0.45p,

outside thread unc#4-40)

③ M3: 4.80mm(inside thread M3.0,

outside thread unc#4-40)

BOARD LOCK DIM. F

4: 4.00mm

7: 3.70mm

CONTACT PLATING

T: SELECTIVE GOLD FLASH

SI: FULL GOLD FLASH

6: FULL TIN

COLOR OF HOUSING

K: BLACK

B: BLUE

SCREW TYPE

A: WITH SCREW TYPE

B: WITH RIVET TYPE

C: WITH SCREW AND RIVET TYPE

D: RIVET TYPE WITH SCREW IN BULD PACKAGE

SHELL PLATING

N: Nickel

T: Tin

CONNECTOR TYPE

M: MALE

F: FEMALE

No. OF CONTACT

09: 9pos.

15: 15pos.

25: 25pos.

37: 37pos.

8 7 6 5 4 3 2 1

8 7 6 5 4 3 2 1

X-ON Electronics

Largest Supplier of Electrical and Electronic Components

Click to view similar products for [D-Sub Standard Connectors](#) category:

Click to view products by [Connfly](#) manufacturer:

Other Similar products are found below :

[DCM37S732N](#) [DAM15P500](#) [DEV09S364GTLF](#) [DEM09P032N](#) [DDM50P732N](#) [DAM15S332N](#) [173109-2218](#) [173109-2466](#) [173109-2436](#)
[173109-2435](#) [56F706-005-LI](#) [56F711-015](#) [015-0341-000](#) [015-0372-008](#) [015-8544-011](#) [017041-0005](#) [012-0515-000](#) [012-9507-034](#) [012-9507-114](#) [012-9534-001](#) [020745-0008](#) [609-25P](#) [M24308/2-23Z](#) [M243082310F](#) [M243082410F](#) [M243082411F](#) [M24308/4-21](#) [CT1A18-11PSA206](#)
[CT1N36-5SC](#) [CT2-16S-17PS](#) [CT2-20-15PCAU](#) [CT2-24-12PS](#) [CT2-24-28PSF127A206](#) [CT2-32-9PC](#) [CT6F9767-14-4-14S-5PC](#)
[CT6FA10SL-4PS](#) [CT7-18-10SC](#) [CT7-18-10SCAU](#) [CT7-18-12SCAU](#) [CT7-18-1PC](#) [CT7-18-1PCAU](#) [CT7-18-21SCAU](#) [M83513/01-FC](#)
[M83723/76W24619 L/C](#) [M85049/48-3-2F](#) [69001-865](#) [6STD09PCM99B70X](#) [6STD09SCT99S40X](#) [6STD15PCT99S40X](#)
[6STD15SCM99B30X](#)