

U TYPE

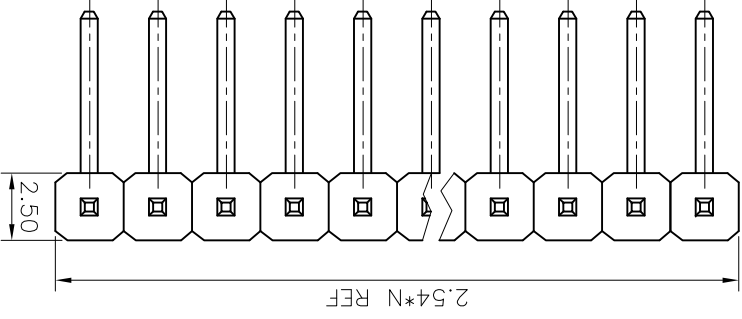

RECOMMEND P.C. BOARD LAYOUT

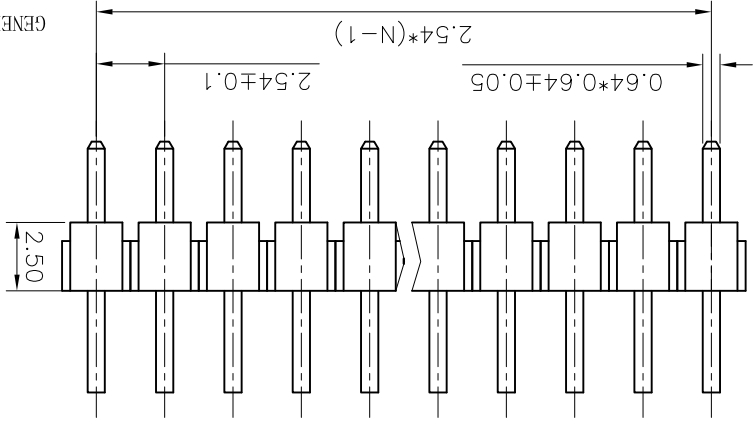
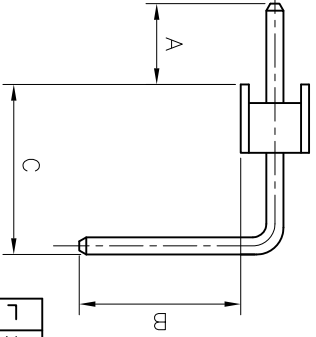
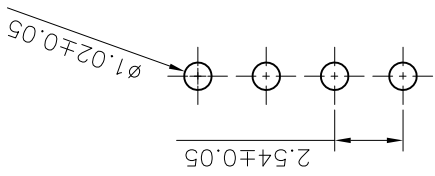
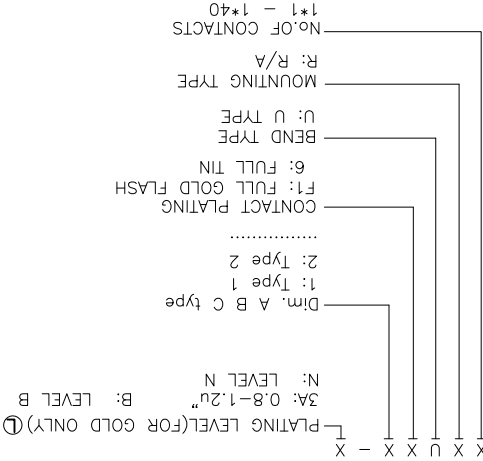

TABLE A:
Dimension Pin Length (mm)

TYPE	Dimension (mm)		
	A	B	C
23	3.00	4.40	4.00
24	3.00	4.75	4.00
25	4.70	4.80	3.70
26	3.00	12.50	5.00
27	5.80	4.30	3.34
28	2.50	5.20	4.30
29	3.00	6.20	6.45
30	3.00	6.00	4.30
31	7.50	7.80	4.00
32	3.00	7.00	6.07
33	3.00	6.00	6.57
34	3.00	4.40	3.88
35	3.07	5.92	6.50
36	3.30	3.15	5.10
37	3.00	6.50	4.50
38	3.00	6.50	5.07
39	6.00	2.40	4.20
40	6.10	3.20	4.36
41	4.20	4.20	4.20
42	2.60	11.00	8.20
43	3.00	6.00	4.00
44	5.72	5.10	4.26
45	3.00	3.00	4.00
46	3.00	5.80	6.50

A/B/C: CUSTOMER LENGTH AVAILABLE

47	3.30	5.80	4.36	14.00
48	3.50	6.32	5.50	15.70
49	4.00	7.90	3.30	15.70
50	3.50	2.20	4.30	10.50
51	3.00	3.00	4.30	10.80
52	3.00	5.20	3.80	12.50



- NOTES:
- 1.1 CONTACT MATERIAL: COPPER ALLOY.
 - 1.2 INSULATOR: PBT WITH GLASS FIBER.
 2. SPECIFICATIONS
2.1 CURRENT RATING: 3A.
2.2 OPERATING TEMPERATURE: -40°C TO +105°C.
2.3 INSULATION RESISTANCE: 1000MΩ MIN.
2.4 CONTACT RESISTANCE: 20mΩ MAX.
2.5 DIELECTRIC WITHSTANDING: 600 VAC.
 3. PRODUCT NUMBER CODE:
DS1022-X X U X X - X

REV.	DESCRIPTION	DRAWN	CHECKED	APPROVED
A	NEW RELEASE	LJH 09/15/05'	~	LJC 09/15/05'
B,C,D	ADD DIM.	LJH 04/04/06'	~	LJC 04/04/06'
F	ADD DIM.	LJH 04/15/06'	~	LJC 04/04/06'
G	整理図面	YCH 03/15/07'	~	LJC 03/15/07'
K	整理図面	YCH 08/12/09'	~	LJC 08/12/09'
L	ADD P/N CODE	LJC 12/08/13'		

GENERAL TOLERANCE		ANGLE TOLERANCE		PROJECTION		UNITS		SHEET SIZE		SERIES		DS1022 SERIES	
X.	±0.60	X.	±5.	mm	A4	2.54mm PIN HEADER R/A TYPE		SINGLE ROW U TYPE					
.XX	±0.38	.X	±3.										
.XX	±0.25	.XX	±2.										
DRAWING TYPE CUSTOMER		SCALE		DRAWING NO.		C-DS1022-1*XXUX-X-L		CONNELY® CONNELY ELECTRONIC CO., LTD		晨翔电子有限公司			
DRAWING TYPE CUSTOMER		SCALE		DRAWING NO.		C-DS1022-1*XXUX-X-L		CONNELY® CONNELY ELECTRONIC CO., LTD		晨翔电子有限公司			
DRAWING TYPE CUSTOMER		SCALE		DRAWING NO.		C-DS1022-1*XXUX-X-L		CONNELY® CONNELY ELECTRONIC CO., LTD		晨翔电子有限公司			

D TYPE

RECOMMEND P.C. BOARD LAYOUT

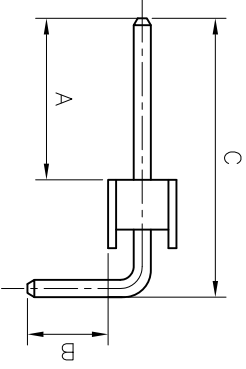
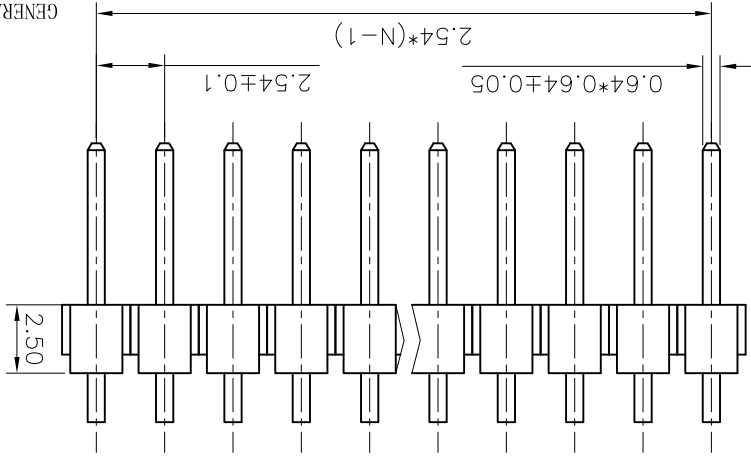
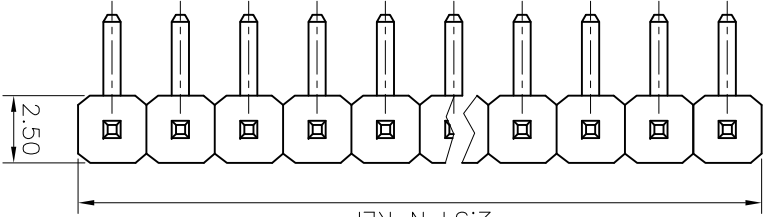
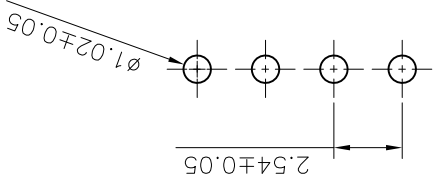

TABLE A:

TYPE	Dimension (mm)			Pin Length
	A	B	C	
1	6.00	3.00	10.36	13.80
2	6.00	4.50	9.50	14.40
3	6.10	4.00	10.40	14.80
4	6.00	3.20	10.50	14.10
5	6.00	3.50	10.82	14.70
6	4.70	1.73	8.20	10.40
7	15.00	3.00	19.08	22.50
8	6.00	3.10	11.10	14.40
9	1.00	1.91	5.00	7.40
10	6.20	3.20	11.10	14.70
11	6.20	3.20	10.8	14.40
12	4.50	2.93	8.00	11.40
13	6.30	2.60	10.36	13.40
14	5.70	2.95	9.52	12.90
15	4.80	3.00	8.10	11.50
16	6.00	3.00	9.14	12.60
17	7.20	3.00	10.36	13.80
18	3.00	6.00	7.50	13.80
19	3.00	6.00	9.32	15.80
20	3.50	3.00	7.86	11.30

A/B/C: CUSTOMER LENGTH AVAILABLE

21	5.00	2.70	8.14	11.30
22	8.20	2.80	12.30	15.50
23	3.00	3.00	7.56	10.80
24	6.50	3.00	10.36	13.80
25	6.80	8.40	10.64	19.50
26	10.00	3.20	14.40	18.00
27	3.50	2.50	7.82	10.80
28	6.00	3.00	9.50	12.90
29	7.00	3.10	13.90	17.50
30	4.00	3.00	8.36	11.80
31	3.00	5.40	8.65	14.50
32	4.50	4.50	8.82	17.80
33	3.20	6.00	7.50	14.00
34	3.80	6.00	8.30	14.80
35	3.00	3.40	8.00	11.80
36	3.80	3.00	7.93	11.20
37	16.4	13.00	19.60	33.00
38	6.85	3.00	10.90	14.30

- NOTES:
- MATERIALS:
 - CONTACT MATERIAL: COPPER ALLOY.
 - INSULATOR: PBT WITH GLASS FIBER.
 - SPECIFICATIONS:
 - CURRENT RATING: 3A.
 - OPERATING TEMPERATURE: -40°C TO +105°C.
 - INSULATION RESISTANCE: 1000MΩ MIN.
 - CONTACT RESISTANCE: 20mΩ MAX.
 - DIELECTRIC WITHSTANDING: 600 VAC.
 - PRODUCT NUMBER CODE: DS1022-X X X X X - X

- PLATING LEVEL(FOR GOLD ONLY) ①
- N: LEVEL N
 3A: 0.8~1.2μ"
 B: LEVEL B
- Dim. A B C type
 1: Type 1
 2: Type 2
 3: Type 3
 4: Type 4
 5: Type 5
 6: Type 6
 7: Type 7
 8: Type 8
- CONTACT PLATING
 F1: FULL GOLD FLASH
 6: FULL TIN
- BEND TYPE
 D: D TYPE
- MOUNTING TYPE
 R: R/A
- NO.OF CONTACTS
 1*1 - 1*40

REV.	DESCRIPTION	DRAWN	CHECKED	APPROVED
A	NEW RELEASE	LJH 04/06/06'	~	LJC 04/06/06'
B	ADD DIM	LL 08/05/06'	~	LJC 04/06/06'
C	增加规格整理图面	YCH 03/15/07'	~	LJC 03/15/07'
J	整理料号	YCH 04/23/08'	~	
K	ADD P/N CODE	LJC 12/08/13'		

GENERAL TOLERANCE		X. ±0.60		X. ±0.38		.XX ±0.25	
ANGLE TOLERANCE		X. ±5.		.X ±3.		.XX ±2.	
DRAWING TYPE		CUSTOMER		DRAWING NO. C-DS1022-1*XXDX-X-K			
SCALE		1:1		SHEET 1 OF 1			

晨翔电子有限公司 CONNPLY CONNPLY ELECTRONIC CO., LTD

2.54mm PIN HEADER R/A TYPE
 SINGLE ROW D TYPE
 DS1022 SERIES
 A4 SHEET SIZE



CONNFLY® 晨翔电子有限公司
CONNFLY ELECTRONIC CO., LTD

GENERAL TOLERANCE	X ±0.60
ANGLE TOLERANCE	X ±3°
PROJECTION	X ±5°
UNITS	mm
SHEET SIZE	A4
SERIES	DS1022 SERIES
TITLE	2 ROWS 2.54mm PIN HEADER R/A TYPE

DRAWING NO.	C-DS1022-2*XXX-X-J	
SCALE	1:1	SHEET 1 OF 1
DRAWING TYPE	CUSTOMER	
UNITS	X ±0.25	.XX ±2°

1. MATERIALS
 1.1 CONTACT MATERIAL: COPPER ALLOY
 1.2 INSULATOR: PBT WITH GLASS FIBER
 2. SPECIFICATIONS
 2.1 CURRENT RATING: 3A
 2.2 OPERATING TEMPERATURE: -40°C TO +105°C
 2.3 INSULATION RESISTANCE: 1000MΩ MIN.
 2.4 CONTACT RESISTANCE: 20mΩ MAX.
 2.5 DIELECTRIC WITHSTANDING: 600 VAC
 3. PRODUCT NUMBER CODE:
 DS1022-X X X X - X
 PLATING LEVEL(FOR GOLD ONLY) ①
 3A: 0.8-1.2u" B: LEVEL B
 N: LEVEL N

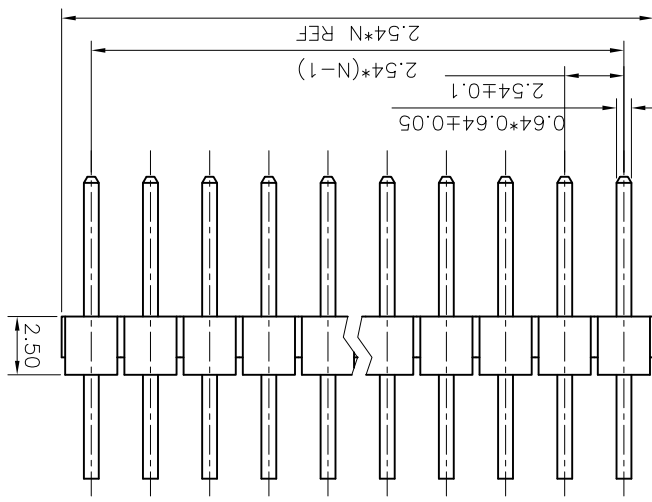
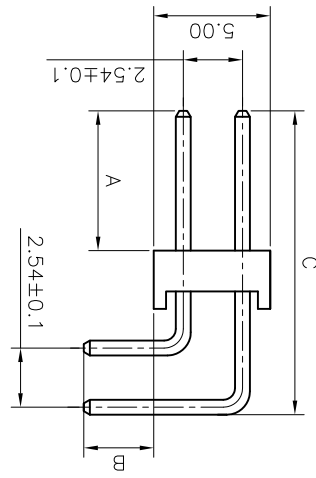
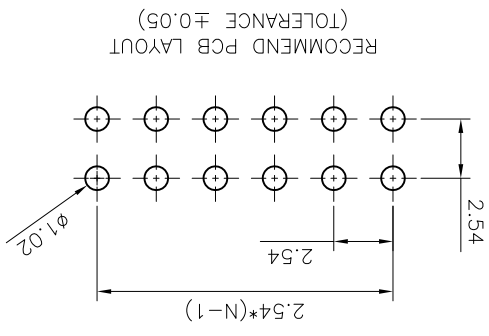
REV.	DESCRIPTION	DRAWN	CHECKED	APPROVED
A	NEW RELEASE	LJH 09/21/05'	~	LJC 09/21/05'
B,C	ADD DIM.	LJH 04/04/06'	~	LJC 04/04/06'
D	ADD DIM.	LL 09/26/06'	~	LJC 09/26/06'
E	整理图画	YCH 03/15/07'	~	LJC 03/15/07'
F	增加SMT尺寸表格	YCH 05/18/07'	~	LJC 05/18/07'
G	整理图画	YCH 07/23/08'	~	LJC 07/23/08'
H	去除SMT类型	YCH 05/28/09'	~	LJC 05/28/09'
J	ADD P/N CODE	JLZ 07/23/14'	~	



RIGHT ANGLE TYPE
N:NUMBER OF CONTACT/2

TYPE	Dimension			Pin Length (mm)
	A	B	C	
12	3.00	3.00	9.90	10.90
13	6.00	3.50	13.04	14.40
14	3.00	9.00	11.90	18.80
15				23.90
16				
17				
18				
19				
20				
21				
22				

TYPE	Dimension			Pin Length (mm)
	A	B	C	
1	6.00	3.00	13.04	14.00
2	6.10	4.00	12.94	14.80
3	6.00	4.00	12.76	14.70
4	9.00	3.00	16.04	22.00
5	6.00	3.00	13.80	14.70
6	5.10	3.00	13.04	14.00
7	6.50	3.00	13.10	14.00
8	3.00	6.00	9.32	13.20
9	3.00	3.00	10.90	11.90
10	7.00	3.10	13.90	20.00
11	4.00	3.00	10.76	16.70

TABLE A:
RIGHT ANGLE/弯针

TYPE	Dimension			Pin Length
	A	B	C	
1	6.00	3.00	15.58	
				Short: 14.0
				Middle: 19.0
				Long: 24.0

TABLE A:

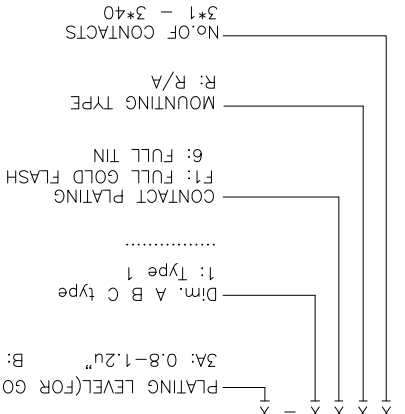
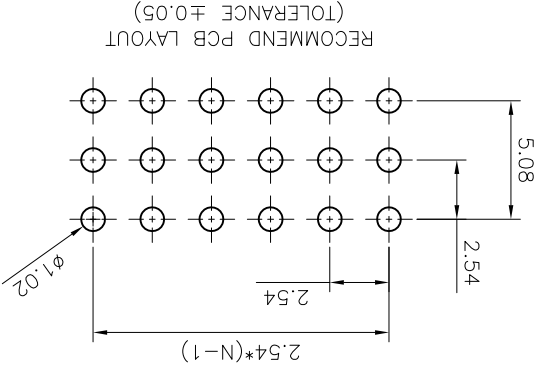
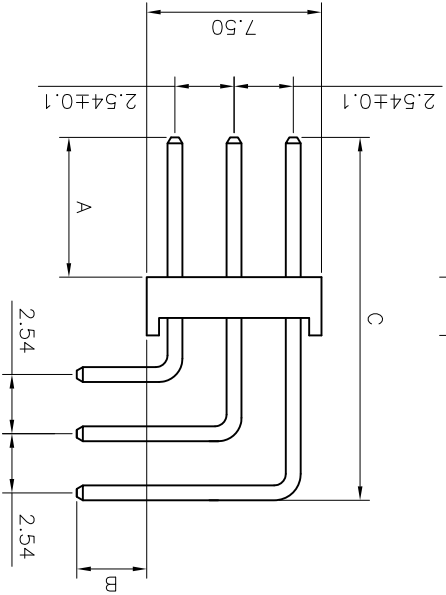
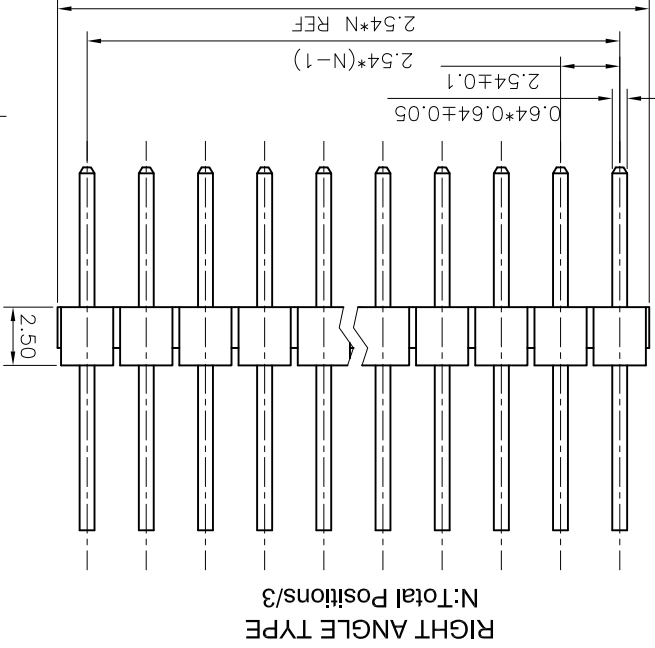

- NOTES:
1. MATERIALS
1.1 CONTACT MATERIAL: COPPER ALLOY.
1.2 INSULATOR: PBT WITH GLASS FIBER.
 2. SPECIFICATIONS
2.1 CURRENT RATING: 3A.
2.2 OPERATING TEMPERATURE: -40°C TO +105°C.
2.3 INSULATION RESISTANCE: 1000MΩ MIN.
2.4 CONTACT RESISTANCE: 20mΩ MAX.
2.5 DIELECTRIC WITHSTANDING: 600 VAC.
 3. PRODUCT NUMBER CODE:
DS1022-X X X X - X
PLATING LEVEL(FOR GOLD ONLY) Ⓟ
3A: 0.8-1.2u" B: LEVEL B
1: Type 1
Dim. A B C type
CONTACT PLATING
F1: FULL GOLD FLASH
6: FULL TIN
MOUNTING TYPE
R: R/A
3*1 - 3*40
NO. OF CONTACTS

GENERAL TOLERANCE ANGLE TOLERANCE PROJECTION		UNITS		SHEET SIZE		SERIES		TITLE	
X ±0.60		mm		A4		DS1022 SERIES		2.54mm PIN HEADER R/A TYPE	
.X ±0.38								3 ROWS	
.XX ±0.25									
DRAWING TYPE CUSTOMER									
SCALE 1:1		SHEET 1 OF 1							
DRAWING NO. C-DS1022-3*XXX-X-B									

CONNLY® CONNLY ELECTRONIC CO., LTD
 晨翔电子有限公司

REV.	DESCRIPTION	DRAWN	CHECKED	APPROVED
A	NEW RELEASE	LJC 09/13/13'	/	LJC 09/13/13'
B	ADD P/N CODE	LJC 12/08/13'		

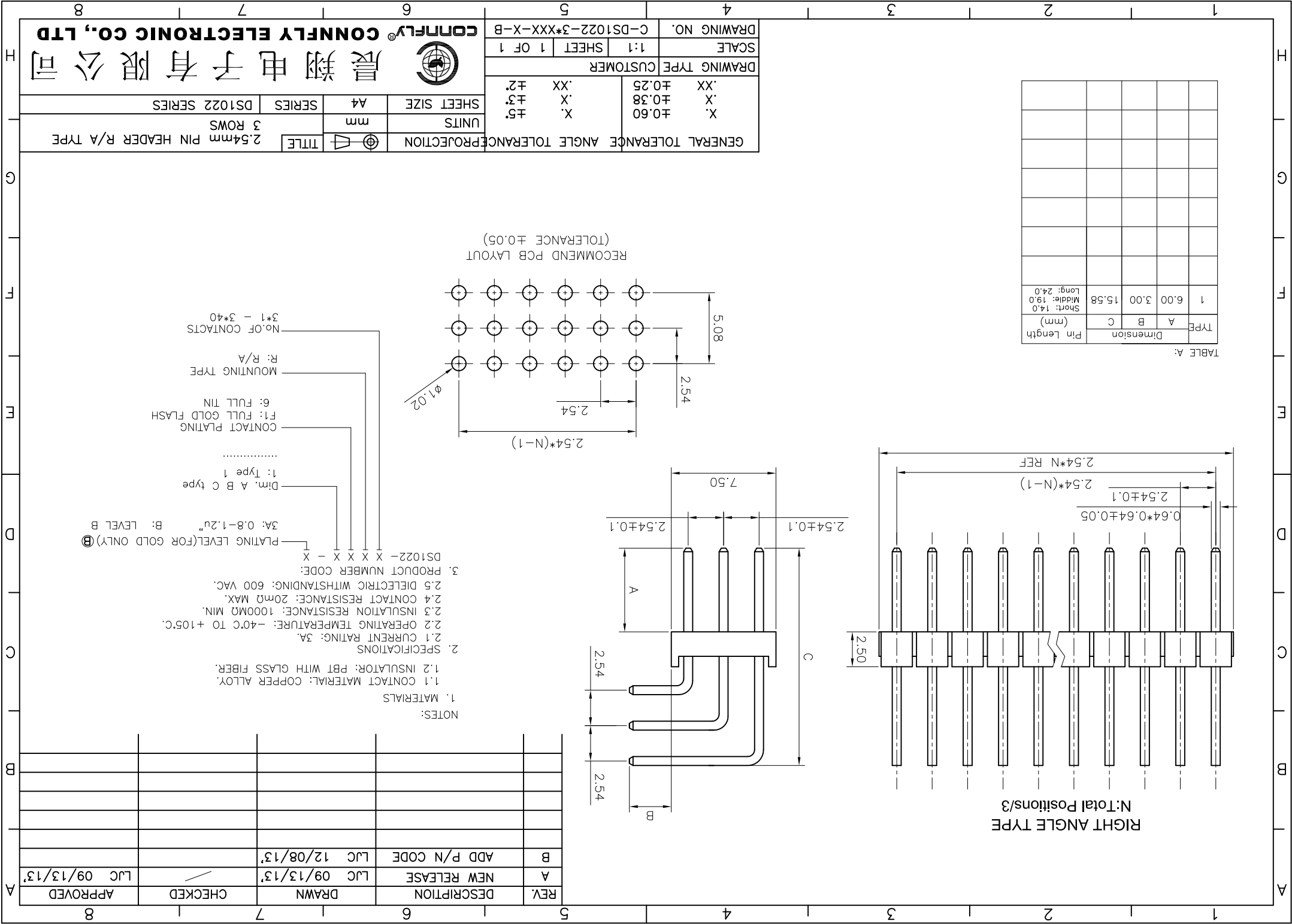

pos.	Dim.d	4~40pin	9.0mm
		2~3pin	5.0mm

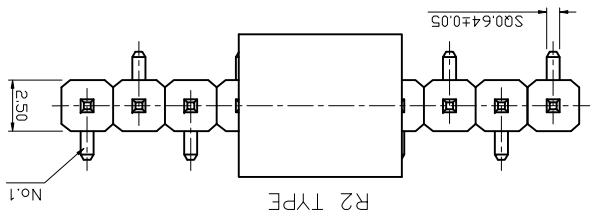
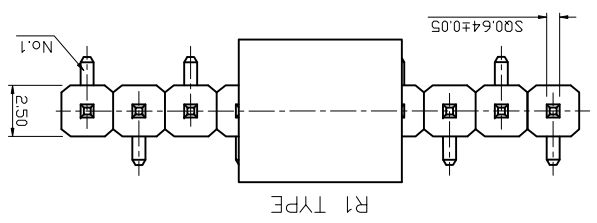
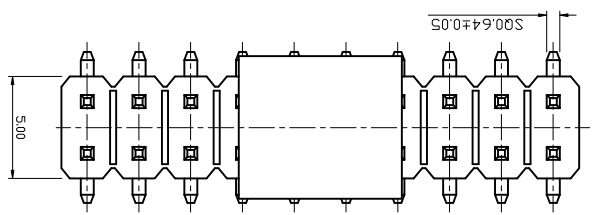
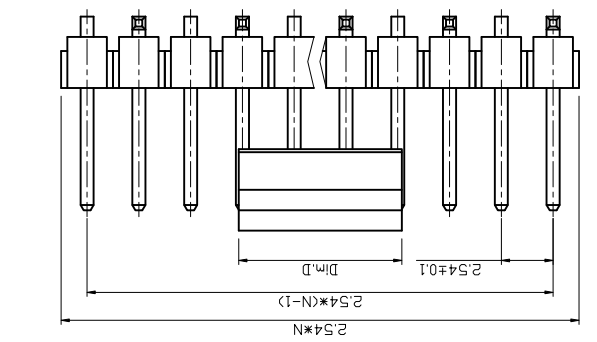

DRAWING NO. C-DS1022-XXXXXXX-X-D	
SCALE 1:1	SHEET 1 OF 1
DRAWING TYPE CUSTOMER	
GENERAL TOLERANCE	±0.60
ANGLE TOLERANCE	±5.0°
	±0.38
	±0.25
	XX ±2.0°

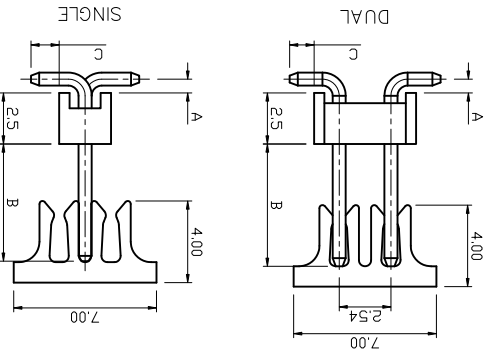

RECOMMEND PCB LAYOUT TOLERANCE=±0.05

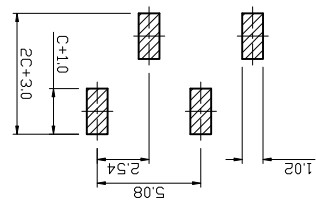
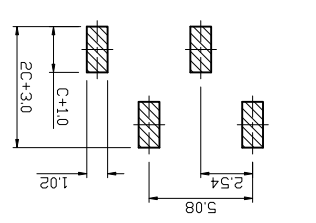
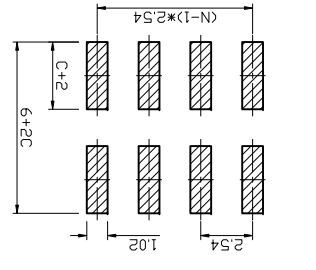

TABLE B:

TYPE	Dimension (mm)			Pin Length
	A	B	C	
1	1.50	6.00	3.00	13.80
2	1.20	6.00	3.00	13.50
3	0.68	7.75	1.20	12.90
4	1.20	8.00	2.50	14.90
5	1.20	6.00	1.20	11.70
6	0.70	6.00	1.40	11.50
7	1.50	6.00	1.20	11.90
8	1.00	5.84	1.40	11.60
9	1.00	8.13	1.40	13.80
10	1.18	11.00	2.50	17.90
11	0.68	4.50	1.40	10.00
	0.48	6.00	1.25	11.00

NOTES:

- MATERIALS
- SPECIFICATIONS
- PRODUCT NUMBER CODE:

PROJECTION	UNITS	SHEET SIZE	SERIES	TITLE
	mm	A4	DS1022 SERIES	PIN HEADER PITCH 2.54mm SMT TYPE

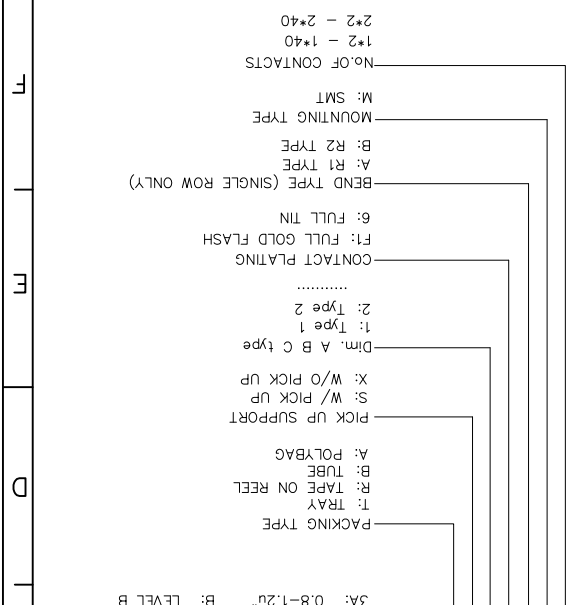

REV.	DESCRIPTION	DRAWN	CHECKED	APPROVED
A	NEW RELEASE	YCH 11/19/10'	~	LJC 11/19/10'
B	ADD P/N CODE	LJC 12/08/13'	~	LJC 12/08/13'
C	PICK UP CHANGE	YCH 04/23/14'	~	LJC 04/23/14'
D	PICK UP CHANGE	LJZ 01/26/16'		

晨翔电子有限公司 CONNFLY ELECTRONIC CO., LTD

X-ON Electronics

Largest Supplier of Electrical and Electronic Components

Click to view similar products for [Headers & Wire Housings](#) category:

Click to view products by [Connfly](#) manufacturer:

Other Similar products are found below :

[95000-104TRLF](#) [10135584-644402LF](#) [DF62W-EP2022PCA](#) [95000-106TRLF](#) [DF62W-2022SCA](#) [48050-002LF](#) [DF62W-EP2022PC](#) [2203348](#)
[DF62W-2022SC](#) [1084018](#) [1029039](#) [1084017](#) [802-10-012-10-002000](#) [1112640](#) [1112639](#) [891-007-9SS-BST1T](#) [000-34000](#) [0008550134](#)
[0009482033](#) [0009507031](#) [0009524054](#) [57102-F02-18ULF](#) [57102-S06-03LF](#) [57202-S52-04LF](#) [PCN6-15S-2.5E](#) [0039019024](#) [58102-G61-](#)
[06LF](#) [582553-1](#) [0009485154](#) [0009508121](#) [0022285053](#) [0050291907](#) [018731A](#) [LY20-4P-DT1-P1E-BR](#) [02.125.8002.8](#) [60101931](#) [60598-1](#)
[\(Cut Strip\)](#) [M1625-3R/100](#) [61062-3](#) [61082-181009](#) [632209-000](#) [636-1427](#) [638009-1](#) [641938-9](#) [641991-4](#) [644168-1](#) [644827-2](#) [647662-1](#)
[65039-019ELF](#) [65692-001LF](#)